

# STARVET

Veterinary Instruments  
Catalogue

**Focus on  
Quality!**

*Aimmax*

[aim-max-medical.dk](http://aim-max-medical.dk)

Almost all General surgery instruments in this catalogue are also available as single use instruments.

Please add SU at the end of general surgery instrument code for single use instruments.

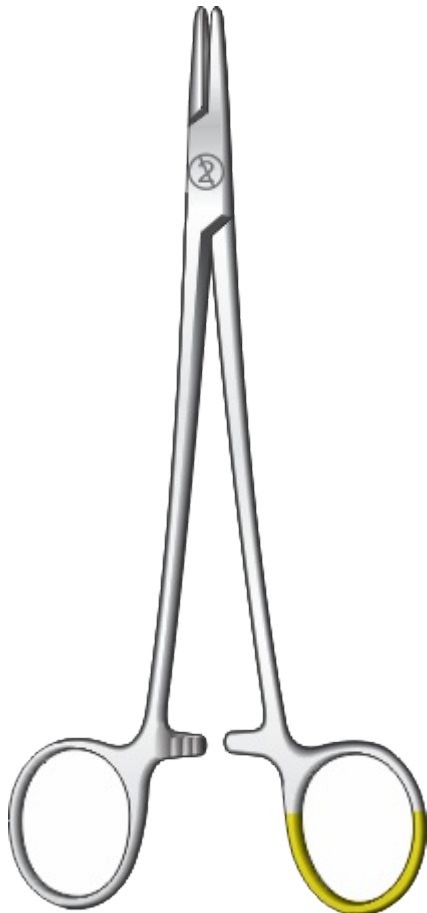

ST02-4743-SU



ST02-0422-SU

Almost all General surgery instruments in this catalogue are also available as single use instruments.

Please add SU at the end of general surgery instrument code for single use instruments.



ST02-1223-SU



ST02-1431-SU

Diagnostic	1	Plates Benders	170-172
Measuring Instruments	2,3	Fixation Clamps & Rods	173
Anaesthesia	4,5	Hand Instruments	174-178
Suction Tubes	6	Ophthalmology	179-190
Scalpel Handles	7,8	ENT Instruments	191-194
Knives	9,10	Body Forceps	195, 196
Scissors	11-26	Neuro Surgery	197-201
Dressing & Tissue Forceps	27-32	Mouth Gags	202
Artery Forceps	33-43	Extraction Forceps	203-209
Intestinal & Stomach	44 -46	Scaler	210-221
Intestinal, Stomach & Spay Forceps	47	Elevators	222, 234
Sponge Forceps	48	Mirrors & Handles	223, 224
Towel Clamps	49	Periodontal Instruments	225
Tubing Clamps	50	Periosteal Sets	226, 227
Obstetrical Forceps	51	Hand Instruments	228, 229
Tongue & Obstetrical	52	Periotomes	230, 231
De Bakey Forceps	53,54, 56	Winged Elevators	232-240
Intestinal & Stomach	55-57	Luxators	241-243
Left Hand Instruments	58 -63	Misce Elevators	244-252
Retractors	64-86	Rodent	253-261
Spay Hooks	70,71	Mouth Gags - Rodent	254
Rib Spreaders	82,83	Cheek Gags - Rodent	255
Probes	87	Rasps & Spatula - Rodent	256
Needle Holders	88-96	Dosing & Biopsy Needles	262, 263
Suture Needles	97	Equine	264-320
Orthopedic	98-112	Restraining	321-328
Drill Box	113	Pig Holders	321-323
Drill Guides	114, 115	Bull Holders	324, 325
Screw Drivers & Racks	116-122	Bull Rings	326
Depth Gouges	123	Pliers	327
Spoons	124, 125	Obstetrical	329-335
Osteotomes, Chisel & Gouges	126-13	Needles & Trocars	336, 337
Elevators	132	Teat Instruments	338-340
Bone Levers	133, 134	Metal Catheters	341
Bone Holding Forceps	135-146	Miscellaneous	342-348
Bone Ronguers	147-152	Snake Sexing Kit	345
Bone Cutters	153, 154	Tagging Pliers	349-350
Rib Shears	155	Grooming Instruments	351-355
Wire Twisters	156, 157	Shears & Trimmers	356, 357
Pliers	158, 159	Animal Combs	358
Wire Storage	160	Sterilization	359-376
Wire Cutters	161-166	Instrument Kits & Sets	377-404
Wire Guides & Wire Passers	167, 168	Index by Code	405-422
Crimping Tools	169	Index Alphabetical	423-436

*Aimax*

# Veterinary Instruments Catalogue

**Veterinary**  
Instruments Catalogue

This catalogue has very detailed and comprehensive indices to find any instrument of your choice,

You can search any instrument by its code or its name from

- Table of contents
- Alphabetical index
- By index by code



ST01-0001  
Otoscope set, consisting of battery handle  
(without batteries), 3 ear specula, 1 bulb, in velvet lined case



ST01-0010



ST01-0011



ST01-0012



ST01-0013



Universal Set  
ST01-0020



Scale  
ST01-0070  
1-20 cm

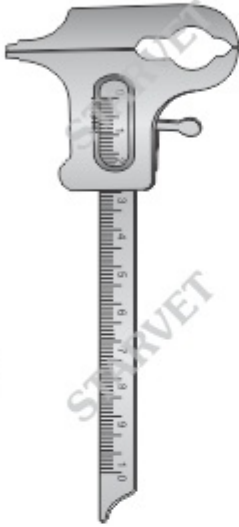

ST01-0030



Jamison  
ST01-0040



Castroviejo  
ST01-0050  
8 cm / 3 1/4"  
Measuring Range 20 mm



ST01-0060  
34 cm / 13 1/2"  
Graduated In Centimeters.

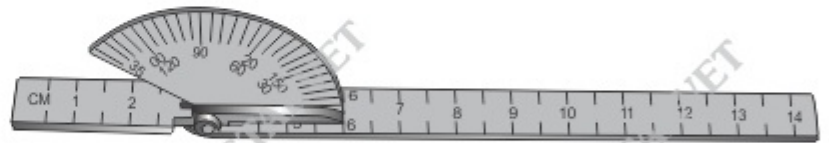

ST01-0080  
Goniometer With Half Dial

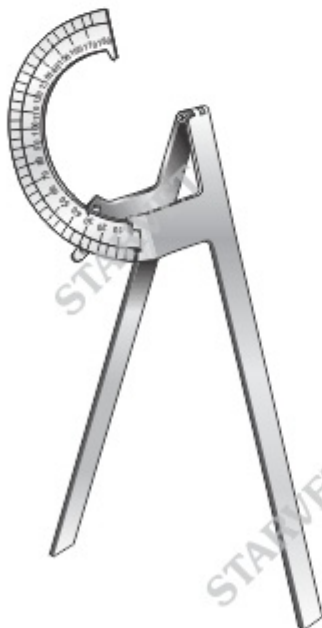

Moltgen  
ST01-0075  
For Extremities



ST01-0090  
Goniometer



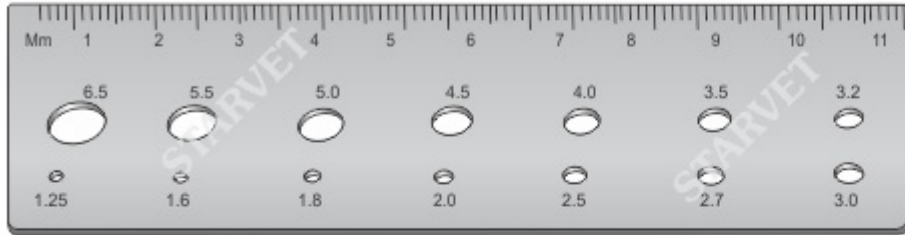

Drill Gauge  
ST01-0100



Drill & Screw Gauge 60 mm  
ST01-0110



Measuring Tape  
ST01-0115  
200 cm

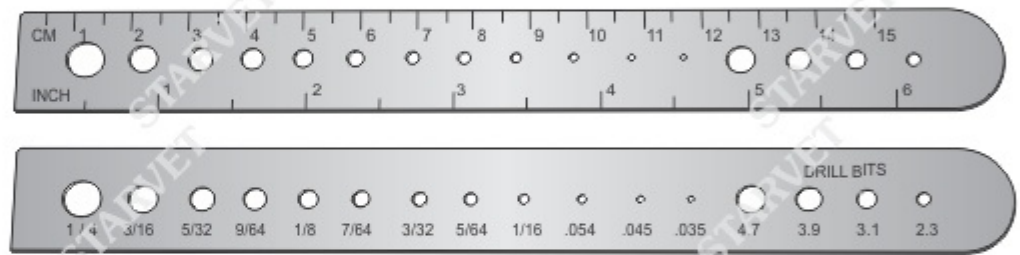

ST01-0120



Dejerine  
ST01-0130  
Stainless Steel  
ST01-0131  
Chrome Plated (Brass)  
20 cm / 8"



Taylor  
ST01-0140 18 cm / 7"  
ST01-0141 20 cm / 8"  
Stainless Steel  
ST01-0142 18 cm / 7"  
ST01-0143 20 cm / 8"  
Chrome Plated (Brass)



ST01-0153  
Spare Rubber Large

ST01-0152  
Spare Rubber Small

ST01-0154  
Spare Needle Only

ST01-0155  
Spare Brush Only

Buck  
ST01-0150  
Stainless Steel  
ST01-0151  
Chrome Plated  
(Brass)  
18 cm / 7"  
With Needle And Brush

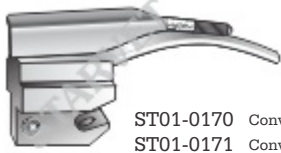

Fig. 00

- ST01-0170 Conventional with bulb
- ST01-0171 Conventional with L.E.D
- ST01-0172 Fiber optic
- ST01-0173 Conceled

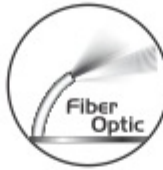

Fig. 0

- ST01-0180 Conventional with bulb
- ST01-0181 Conventional with L.E.D
- ST01-0182 Fiber optic
- ST01-0183 Conceled



Fig. 1

- ST01-0190 Conventional with bulb
- ST01-0191 Conventional with L.E.D
- ST01-0192 Fiber optic
- ST01-0193 Conceled



Fig. 2

- ST01-0200 Conventional with bulb
- ST01-0201 Conventional with L.E.D
- ST01-0202 Fiber optic
- ST01-0203 Conceled



Fig. 3

- ST01-0210 Conventional with bulb
- ST01-0211 Conventional with L.E.D
- ST01-0212 Fiber optic
- ST01-0213 Conceled



Fig. 4

- ST01-0220 Conventional with bulb
- ST01-0221 Conventional with L.E.D
- ST01-0222 Fiber optic
- ST01-0223 Conceled



**Mc Intosh**  
**ST01-0160**

Conventional Laryngoscope set with medium handle  
Set of 3, Fig.1-Fig.3

**ST01-0161**

Conventional Laryngoscope set with medium handle  
Set of 4, Fig.1-Fig.4

**ST01-0162**

Fiber optic laryngoscope set with medium handle  
Set of 3, Fig.1-Fig.3

**ST01-0163**

Fiber optic laryngoscope set with medium handle  
Set of 4, Fig.1-Fig.4



**ST01-0230**  
Spare small handle  
Conventional



**ST01-0240**  
Spare medium handle  
Conventional



**ST01-0250**  
Spare large handle  
Conventional

**ST01-0231**  
Spare small handle  
Fiber optic

**ST01-0241**  
Spare medium handle  
Fiber optic

**ST01-0251**  
Spare large handle  
Fiber optic

**ST01-0232**  
Spare small handle  
L.E.D

**ST01-0242**  
Spare medium handle  
L.E.D

**ST01-0252**  
Spare large handle  
L.E.D



**Miller**

- ST01-0260 Conventional laryngoscope set with medium handle  
Set of 3, fig. 1-fig. 3
- ST01-0261 Conventional laryngoscope set with medium handle  
Set of 4, fig. 1-fig. 4
- ST01-0262 Fiber optic laryngoscope set with medium handle  
Set of 3, fig. 1-fig. 3
- ST01-0263 Fiber optic laryngoscope set with medium handle  
Set of 4, fig. 1-fig. 4

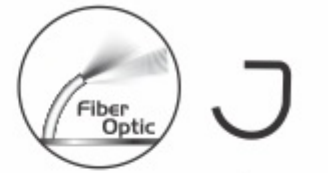

- ST01-0280 Conventional with bulb
- ST01-0281 Conventional with L.E.D
- ST01-0282 Fiber optic

Fig. 00



- ST01-0290 Conventional with bulb
- ST01-0291 Conventional with L.E.D
- ST01-0292 Fiber optic

Fig. 0

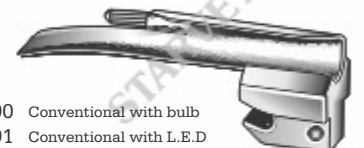

- ST01-0300 Conventional with bulb
- ST01-0301 Conventional with L.E.D
- ST01-0302 Fiber optic

Fig. 1



- ST01-0310 Conventional with bulb
- ST01-0311 Conventional with L.E.D
- ST01-0312 Fiber optic

Fig. 2



- ST01-0320 Conventional with bulb
- ST01-0321 Conventional with L.E.D
- ST01-0322 Fiber optic

Fig. 3



- ST01-0330 Conventional with bulb
- ST01-0331 Conventional with L.E.D
- ST01-0332 Fiber optic

Fig. 4

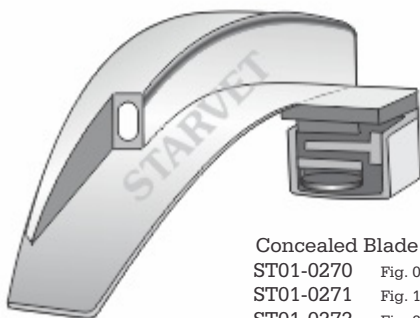

**Concealed Blade**

- ST01-0270 Fig. 0
- ST01-0271 Fig. 1
- ST01-0272 Fig. 2
- ST01-0273 Fig. 3
- ST01-0274 Fig. 4



**Yankauer**

ST01-0340	ST01-0341
23 cm / 9"	23 cm / 9"
Chrome plated	Stainless steel
ST01-0342	ST01-0343
27 cm / 10½"	27 cm / 10½"
Chrome plated	Stainless steel
Without thumb control	

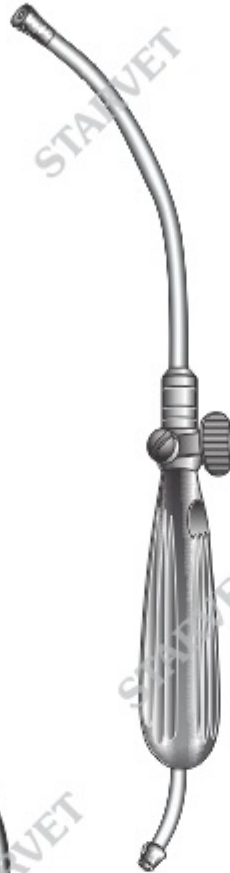

**Yankauer**  
ST01-0350 Stainless steel  
ST01-0351 Chrome plated  
28 cm / 11"  
With thumb control



**Adson**  
ST01-0380  
21 cm / 8½"  
4 mm Ø



**Frazier**

	Fr.	mm
ST01-0360	06	2
ST01-0361	07	2.3
ST01-0362	08	2.6
ST01-0363	09	3
ST01-0364	10	3.3
ST01-0365	11	3.6
ST01-0366	12	4
ST01-0367	14	4.6
ST01-0368	16	5
		19 cm / 7½"



**Poole**  
Stainless steel  
22 cm / 8¾"  
ST01-0390  
8 mm Ø, (Fr. 23)  
ST01-0391  
10 mm Ø, (Fr. 30)



**Poole**  
Stainless steel  
22 cm / 8¾"  
ST01-0400  
8 mm Ø, (Fr. 23)  
ST01-0401  
10 mm Ø, (Fr. 30)

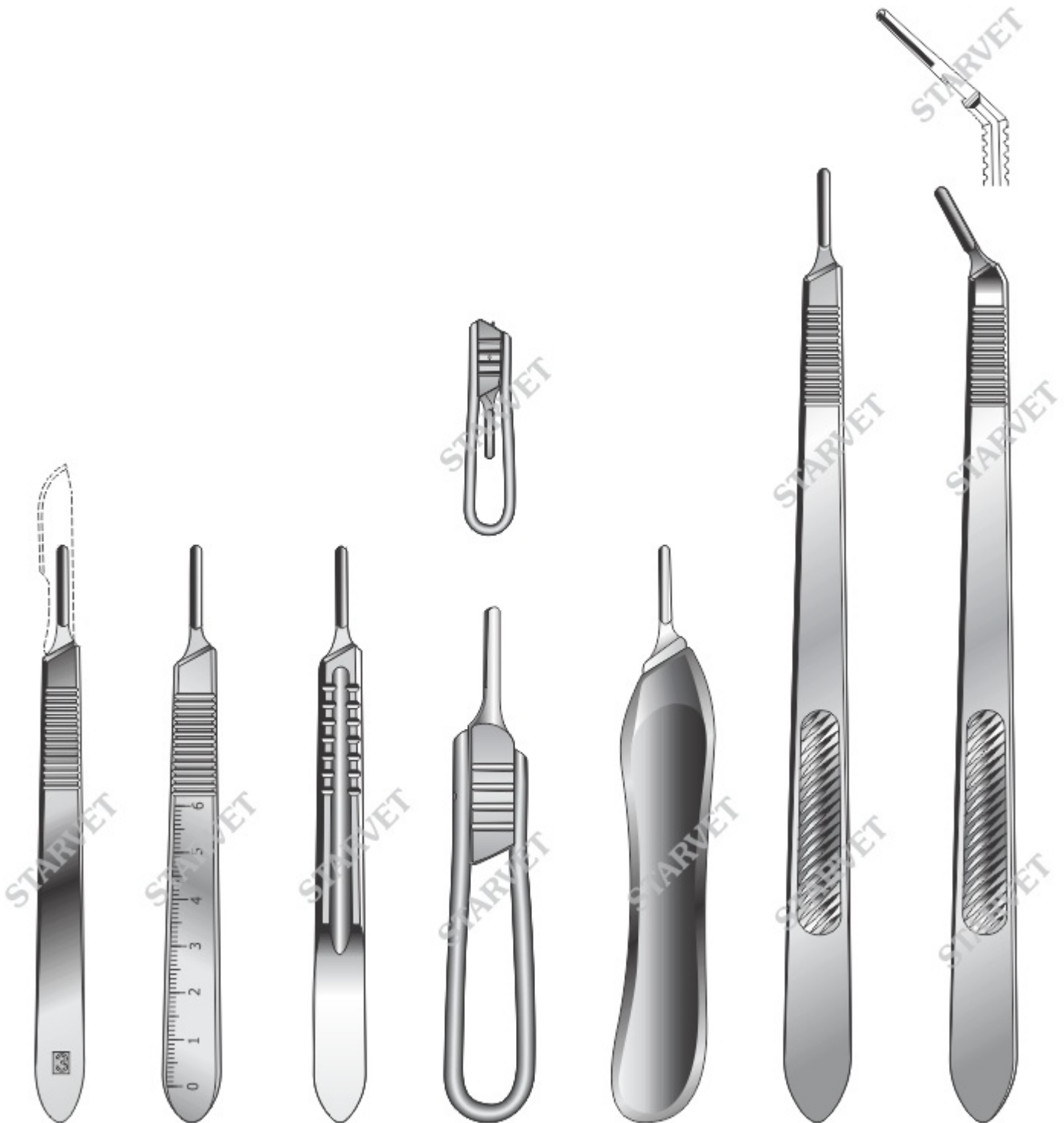

Standard  
ST02-0001  
No. 3  
Solid

ST02-0010  
No. 3  
Solid, with scale

ST02-0020  
No. 3  
Solid

Folding Scalpel Handle  
ST02-0030 No. 3  
ST02-0031 No. 4  
Solid, Pocket Style

ST02-0040  
No. 3  
Plastics

ST02-0050  
No. 3L  
Solid straight

ST02-0060  
No. 3L  
Solid angled



ST02-0101  
No. 4L  
Solid angled



Standard  
ST02-0070  
No. 4  
Solid



ST02-0080  
No. 4  
Graduated in mm



ST02-0090  
No. 4  
Plastics



ST02-0100  
No. 4L  
Solid straight



ST02-0110  
No. 7  
Long



ST02-0120  
No. 7  
Solid



ST02-0121  
No. 7K  
Solid



ST02-0122  
No. 5  
Solid



Spine Wrench  
ST02-0150  
22.5 cm / 8¾"



ST02-0160  
14 cm / 5½"



ST02-0161  
14.5 cm / 5¾"



ST02-0162  
15 cm / 6"



ST02-0163  
15.5 cm / 6"



ST02-0164  
16 cm / 6¼"



ST02-0165  
16.5 cm / 6½"



ST02-0166  
17 cm / 6¾"



ST02-0167  
17.5 cm / 7"



ST02-0168  
18 cm / 7"



ST02-0169  
18 cm / 7"



ST02-0180  
14 cm / 5½"



ST02-0181  
14.5 cm / 5¾"



ST02-0182  
15 cm / 6"



ST02-0183  
15.5 cm / 6"



ST02-0184  
16 cm / 6¼"



ST02-0185  
16.5 cm / 6½"



ST02-0186  
17 cm / 6¾"



ST02-0187  
17.5 cm / 7"



ST02-0188  
17 cm / 6¾"



ST02-0189  
17 cm / 6¾"



ST02-0195  
9.5 cm / 3¾"



ST02-0196  
Brain Knife





Standard		Micro Tone*
ST02-0200	10.5 cm / 4¼"	ST02-0201
ST02-0202	11.5 cm / 4½"	ST02-0203
ST02-0204	13.0 cm / 5"	ST02-0205
ST02-0206	14.5 cm / 5½"	ST02-0207
ST02-0208	15.5 cm / 6"	ST02-0209
ST02-0210	16.5 cm / 6½"	ST02-0211
ST02-0212	18.5 cm / 7¼"	ST02-0213
ST02-0214	20.0 cm / 8"	ST02-0215

Blunt / Blunt  
Straight



Standard		Micro Tone*
ST02-0220	10.5 cm / 4¼"	ST02-0221
ST02-0222	11.5 cm / 4½"	ST02-0223
ST02-0224	13.0 cm / 5"	ST02-0225
ST02-0226	14.5 cm / 5½"	ST02-0227
ST02-0228	15.5 cm / 6"	ST02-0229
ST02-0230	16.5 cm / 6½"	ST02-0231
ST02-0232	18.5 cm / 7¼"	ST02-0233
ST02-0234	20.0 cm / 8"	ST02-0235

Sharp / Blunt  
Straight



Standard		Micro Tone*
ST02-0240	10.5 cm / 4¼"	ST02-0241
ST02-0242	11.5 cm / 4½"	ST02-0243
ST02-0244	13.0 cm / 5"	ST02-0245
ST02-0246	14.5 cm / 5½"	ST02-0247
ST02-0248	15.5 cm / 6"	ST02-0249
ST02-0250	16.5 cm / 6½"	ST02-0251
ST02-0252	18.5 cm / 7¼"	ST02-0253
ST02-0254	20.0 cm / 8"	ST02-0255

Sharp / Sharp  
Straight

\* Micro Tone - One blade like knife & one ring gold plated

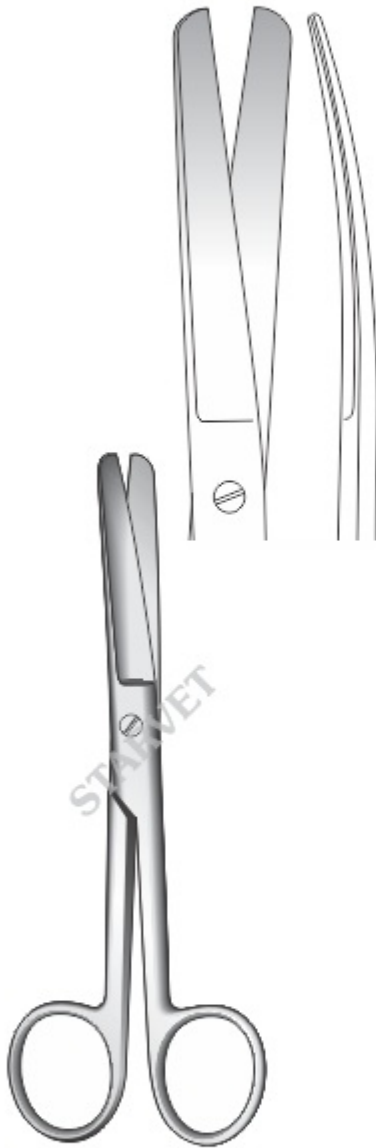

Standard		Micro Tone*
ST02-0260	11.5 cm / 4½"	ST02-0261
ST02-0262	13.0 cm / 5"	ST02-0263
ST02-0264	14.5 cm / 5½"	ST02-0265
ST02-0266	15.5 cm / 6"	ST02-0267
ST02-0268	16.5 cm / 6½"	ST02-0269
ST02-0270	18.5 cm / 7¼"	ST02-0271
ST02-0272	20.0 cm / 8"	ST02-0273

Blunt / Blunt  
Curved

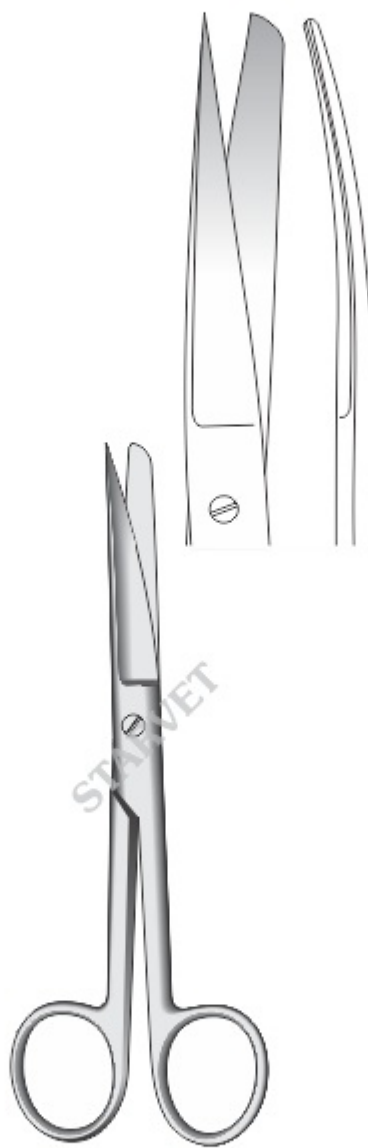

Standard		Micro Tone*
ST02-0280	11.5 cm / 4½"	ST02-0281
ST02-0282	13.0 cm / 5"	ST02-0283
ST02-0284	14.5 cm / 5½"	ST02-0285
ST02-0286	15.5 cm / 6"	ST02-0287
ST02-0288	16.5 cm / 6½"	ST02-0289
ST02-0290	18.5 cm / 7¼"	ST02-0291
ST02-0292	20.0 cm / 8"	ST02-0293

Sharp / Blunt  
Curved



Standard		Micro Tone*
ST02-0300	11.5 cm / 4½"	ST02-0301
ST02-0302	13.0 cm / 5"	ST02-0303
ST02-0304	14.5 cm / 5½"	ST02-0305
ST02-0306	15.5 cm / 6"	ST02-0307
ST02-0308	16.5 cm / 6½"	ST02-0309
ST02-0310	18.5 cm / 7¼"	ST02-0311
ST02-0312	20.0 cm / 8"	ST02-0313

Sharp / Sharp  
Curved



Standard with clip  
 ST02-0204A 13.0 cm / 5"  
 ST02-0206A 14.5 cm / 5½"  
 ST02-0208A 15.5 cm / 6"  
 Blunt / Blunt  
 Straight



Standard with clip  
 ST02-0224A 13.0 cm / 5"  
 ST02-0226A 14.5 cm / 5½"  
 ST02-0228A 15.5 cm / 6"  
 Sharp / Blunt  
 Straight



Standard with clip  
 ST02-0244A 13.0 cm / 5"  
 ST02-0246A 14.5 cm / 5½"  
 ST02-0248A 15.5 cm / 6"  
 Sharp / Sharp  
 Straight

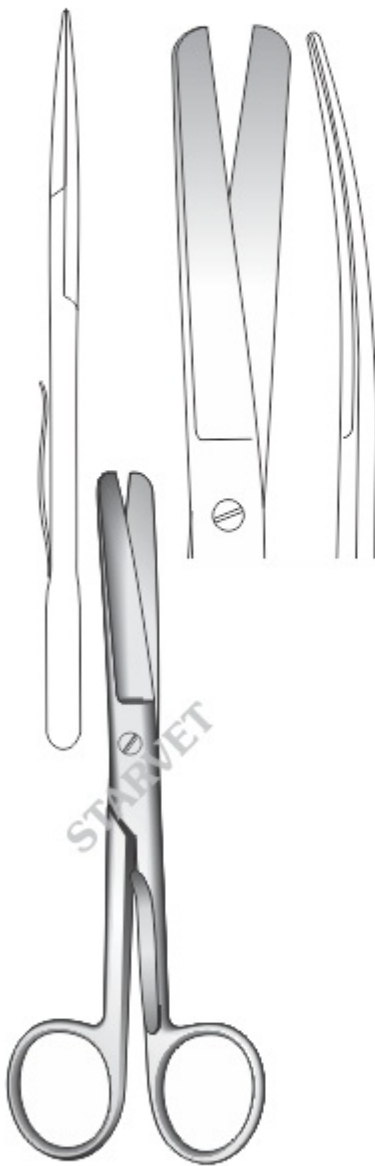

Standard with clip  
 ST02-0264A 13.0 cm / 5"  
 ST02-0266A 14.5 cm / 5½"  
 ST02-0268A 15.5 cm / 6"  
 Blunt / Blunt  
 Curved



Standard with clip  
 ST02-0284 13.0 cm / 5"  
 ST02-0286 14.5 cm / 5½"  
 ST02-0288 15.5 cm / 6"  
 Sharp / Blunt  
 Curved



Standard with clip  
 ST02-0304 13.0 cm / 5"  
 ST02-0306 14.5 cm / 5½"  
 ST02-0308 15.5 cm / 6"  
 Sharp / Sharp  
 Curved



Mayo

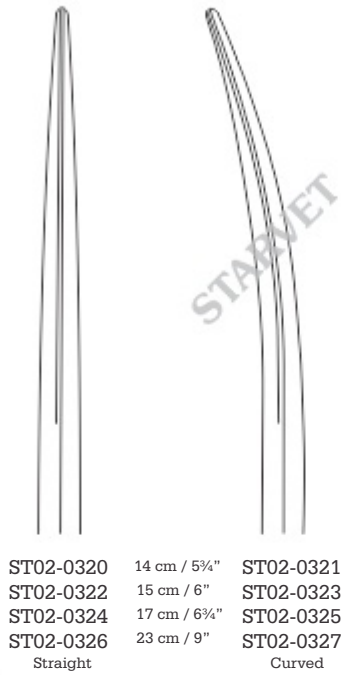

Mayo Stille

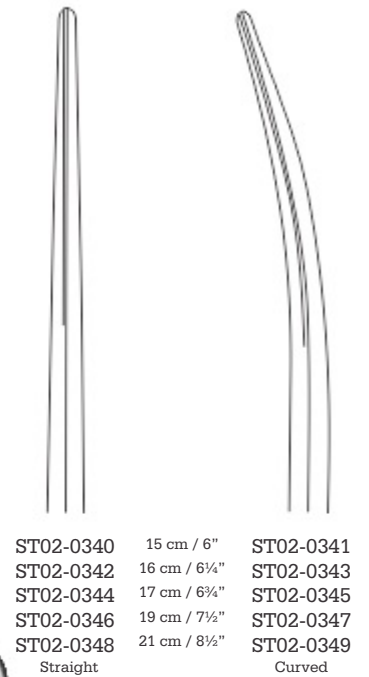

Deaver  
14 cm / 5½"

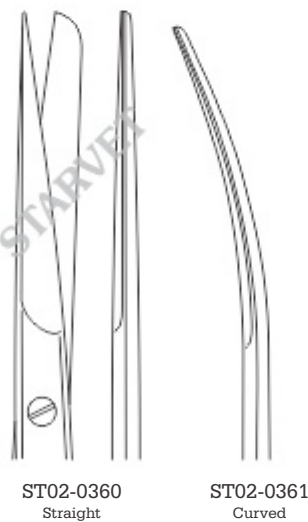

Incision  
ST02-0370 13 cm / 5"  
ST02-0371 14 cm / 5½"

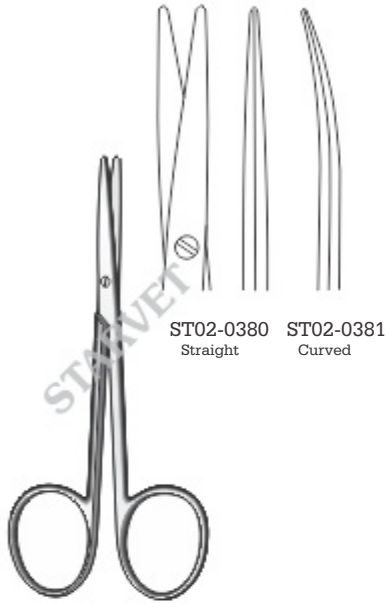

ST02-0380 Straight  
ST02-0381 Curved

Metzenbaum  
11.5 cm / 4½"



ST02-0390 Straight  
ST02-0391 Curved

Metzenbaum  
15 cm / 6"

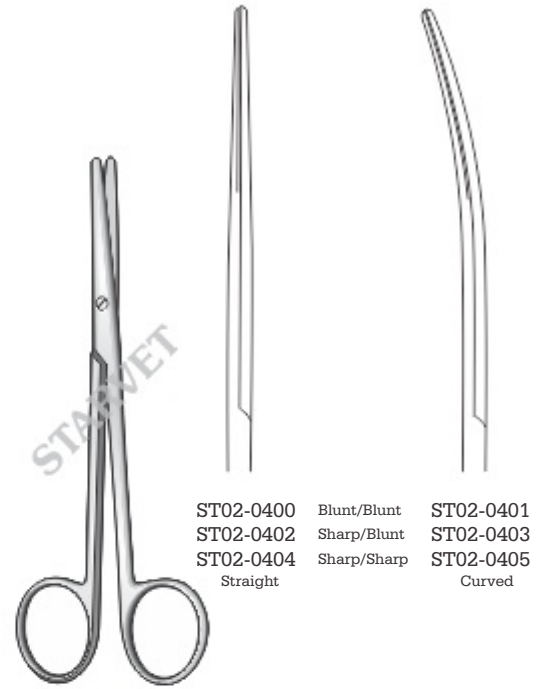

ST02-0400 Blunt/Blunt  
ST02-0402 Sharp/Blunt  
ST02-0404 Sharp/Sharp  
ST02-0401 Curved  
ST02-0403  
ST02-0405

Metzenbaum  
14.5 cm / 5½"



ST02-0410 18 cm / 7"  
ST02-0411 20 cm / 8"  
ST02-0412 23 cm / 9"  
ST02-0413 25 cm / 10"  
ST02-0414 28 cm / 11"  
ST02-0415 30 cm / 12"

Metzenbaum  
Straight

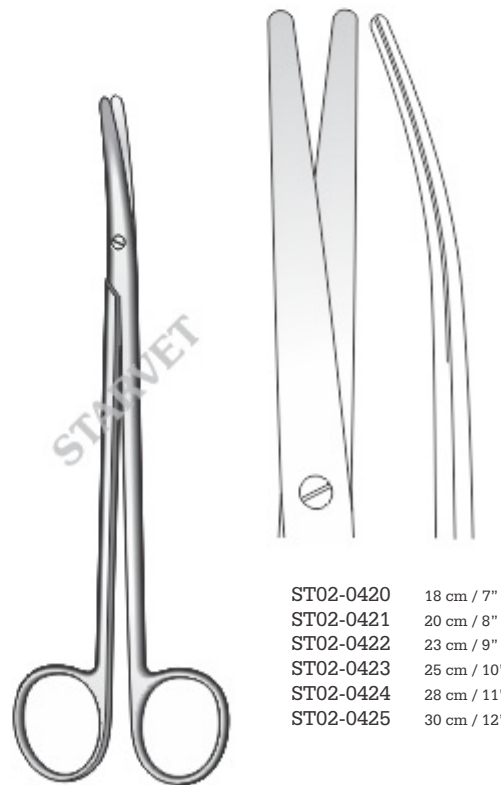

ST02-0420 18 cm / 7"  
ST02-0421 20 cm / 8"  
ST02-0422 23 cm / 9"  
ST02-0423 25 cm / 10"  
ST02-0424 28 cm / 11"  
ST02-0425 30 cm / 12"

Metzenbaum  
Curved

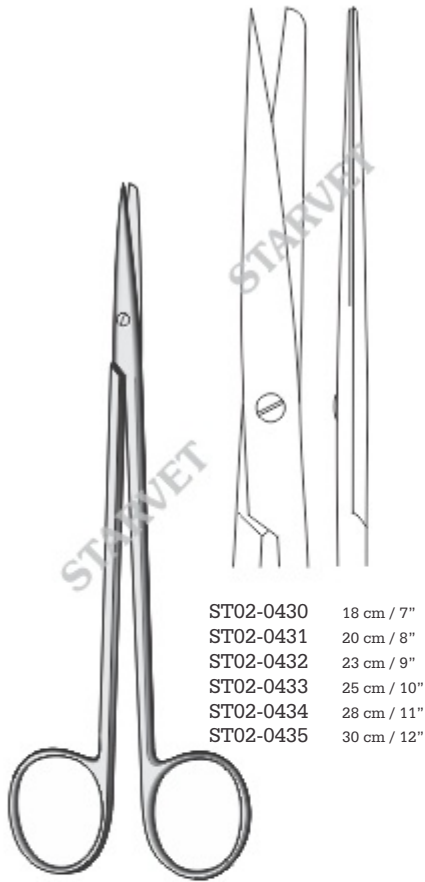

- ST02-0430 18 cm / 7"
- ST02-0431 20 cm / 8"
- ST02-0432 23 cm / 9"
- ST02-0433 25 cm / 10"
- ST02-0434 28 cm / 11"
- ST02-0435 30 cm / 12"

Metzenbaum-Nelson  
Straight



- ST02-0440 18 cm / 7"
- ST02-0441 20 cm / 8"
- ST02-0442 23 cm / 9"
- ST02-0443 25 cm / 10"
- ST02-0444 28 cm / 11"
- ST02-0445 30 cm / 12"

Metzenbaum-Nelson  
Curved

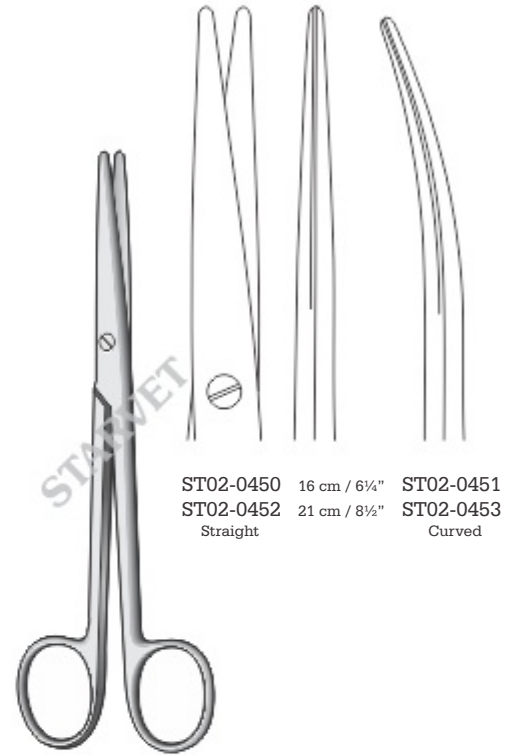

- ST02-0450 16 cm / 6¼"
  - ST02-0452 21 cm / 8½"
  - ST02-0451 18 cm / 7"
  - ST02-0453 28 cm / 11"
- Straight
- Curved

Lexer

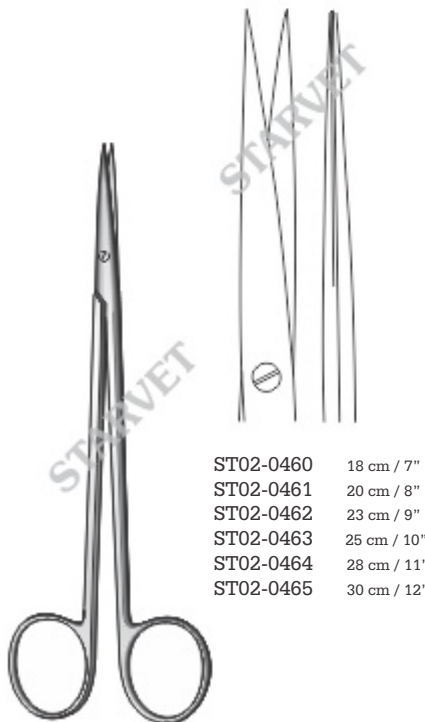

- ST02-0460 18 cm / 7"
- ST02-0461 20 cm / 8"
- ST02-0462 23 cm / 9"
- ST02-0463 25 cm / 10"
- ST02-0464 28 cm / 11"
- ST02-0465 30 cm / 12"

Metzenbaum-Nelson  
Straight



- ST02-0470 18 cm / 7"
- ST02-0471 20 cm / 8"
- ST02-0472 23 cm / 9"
- ST02-0473 25 cm / 10"
- ST02-0474 28 cm / 11"
- ST02-0475 30 cm / 12"

Metzenbaum-Nelson  
Curved

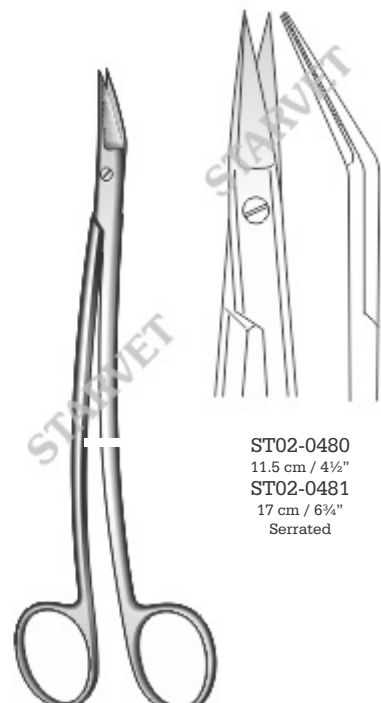

- ST02-0480 11.5 cm / 4½"
  - ST02-0481 17 cm / 6¾"
- Serrated

Dean



**Metzenbaum-Fino**  
ST02-0490 14.5 cm / 5½"  
ST02-0491 18 cm / 7"  
ST02-0492 20 cm / 8"  
ST02-0493 23 cm / 9"  
Slender Pattern  
Straight

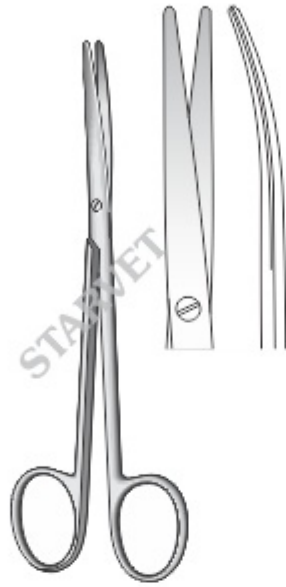

**Metzenbaum-Fino**  
ST02-0500 14.5 cm / 5½"  
ST02-0501 18 cm / 7"  
ST02-0502 20 cm / 8"  
ST02-0503 23 cm / 9"  
Slender pattern  
Curved



**Metzenbaum-Fino**  
ST02-0510 14.5 cm / 5½"  
ST02-0511 18 cm / 7"  
ST02-0512 20 cm / 8"  
ST02-0513 23 cm / 9"  
Slender pattern  
Straight



**Metzenbaum-Fino**  
ST02-0520 14.5 cm / 5½"  
ST02-0521 18 cm / 7"  
ST02-0522 20 cm / 8"  
ST02-0523 23 cm / 9"  
Slender pattern  
Curved



**Lexer-Fino**  
ST02-0530  
16 cm / 6¼"  
Slender pattern  
Straight

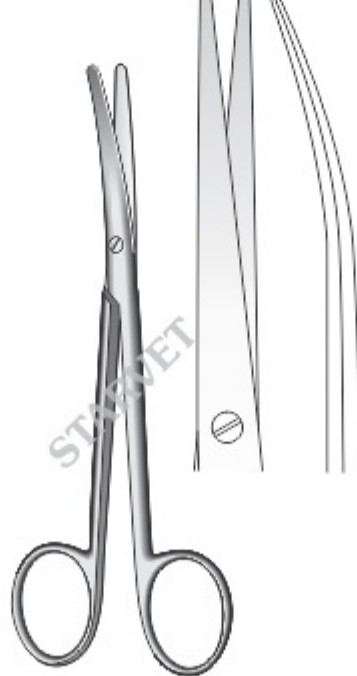

**Lexer-Fino**  
ST02-0540  
16 cm / 6¼"  
Slender pattern  
Curved



**Lexer-Baby**  
10 cm / 4"



ST02-0551  
Curved





ST02-0560  
Straight

ST02-0561  
Curved

11 cm / 4½"  
Dissecting post mortem scissors



ST02-0570  
ST02-0572  
Straight, Flat

9 cm / 3½"  
10.5 cm / 4¼"

ST02-0571  
ST02-0573  
Curved, Flat

ST02-0574  
ST02-0576  
Straight, Round

9 cm / 3½"  
10.5 cm / 4¼"

ST02-0575  
ST02-0577  
Curved, Round

Iris-Fine



ST02-0590  
11.5 cm / 4½"  
Straight, Flat

ST02-0591  
11.5 cm / 4½"  
Curved, Flat

ST02-0592  
11.5 cm / 4½"  
Straight, Round

ST02-0593  
11.5 cm / 4½"  
Curved, Round

Iris

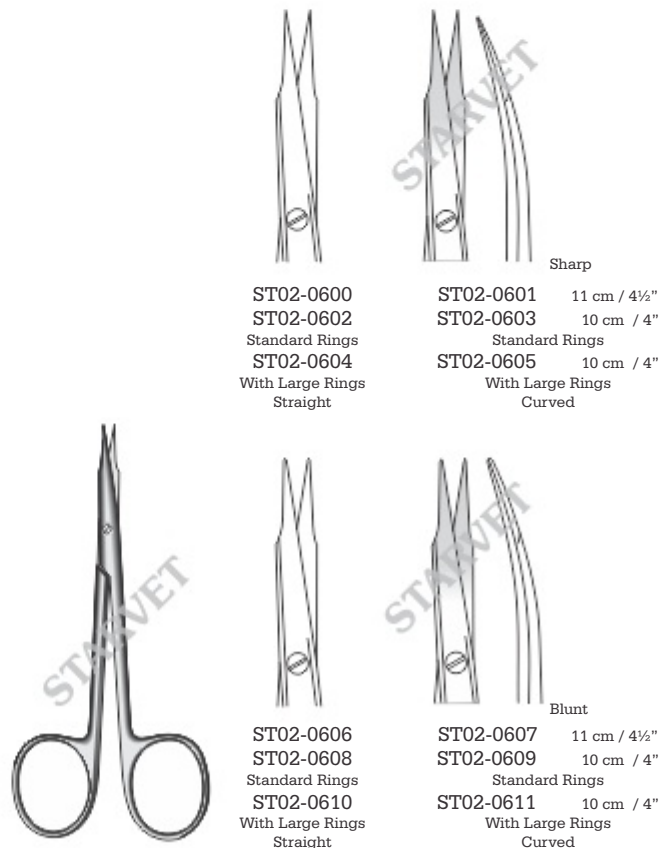

ST02-0600  
ST02-0602  
Standard Rings  
ST02-0604  
With Large Rings  
Straight

ST02-0601 11 cm / 4½"  
ST02-0603 10 cm / 4"  
Standard Rings  
ST02-0605 10 cm / 4"  
With Large Rings  
Curved

ST02-0606  
ST02-0608  
Standard Rings  
ST02-0610  
With Large Rings  
Straight

ST02-0607 11 cm / 4½"  
ST02-0609 10 cm / 4"  
Standard Rings  
ST02-0611 10 cm / 4"  
With Large Rings  
Curved

Steven



Stevens Tenotomy Scissors  
ST02-0620  
11.5 cm / 4½"  
Straight  
Blunt/Sharp

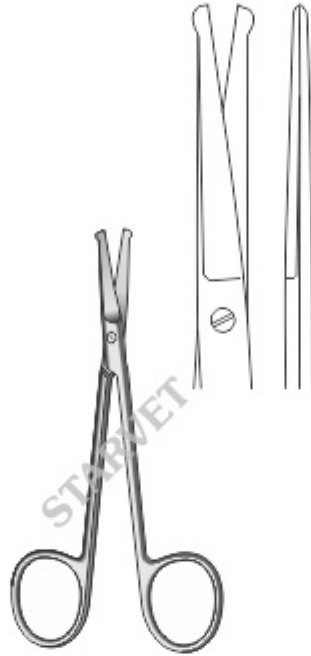

Stevens Tenotomy Scissors  
ST02-0630  
11.5 cm / 4½"  
Straight  
Blunt/Blunt



Dandy  
17 cm / 6¾"

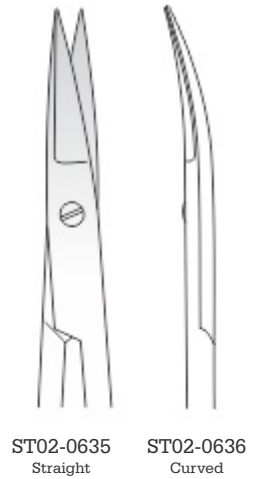

ST02-0635  
Straight

ST02-0636  
Curved



ST02-0640  
9 cm / 3½"  
ST02-0642  
11.5 cm / 4½"  
Straight

ST02-0641  
9 cm / 3½"  
ST02-0643  
11.5 cm / 4½"  
Curved

Strabismus



ST02-0650  
Straight  
ST02-0651  
Curved

Kilner  
11.5 cm / 4½"



Heath-Stitch  
ST02-0660  
15 cm / 6"



La Grange  
ST02-0665  
11 cm / 4¼"  
One Blade Serrated  
Angled Shank, S-Shaped



**Spencer**  
 ST02-0670 Normal ST02-0671  
 ST02-0672 Angled ST02-0673  
 ST02-0674 Delicate, Normal ST02-0675  
 ST02-0676 Delicate, Angled ST02-0677  
 9 cm / 3½" 11 cm / 4¼"



**Spencer**  
 ST02-0690 Straight  
 ST02-0691 Side Curved  
 13 cm / 5"



**Littauer**  
 ST02-0700  
 14 cm / 5½"



ST02-0710  
 10 cm / 4"  
 Straight



ST02-0711  
 10 cm / 4"  
 Curved



ST02-0712  
 12 cm / 4¾"  
 1 Blade saw edge  
 Straight



ST02-0713  
 12 cm / 4¾"  
 1 Blade saw edge  
 Curved



Crown-Beebe

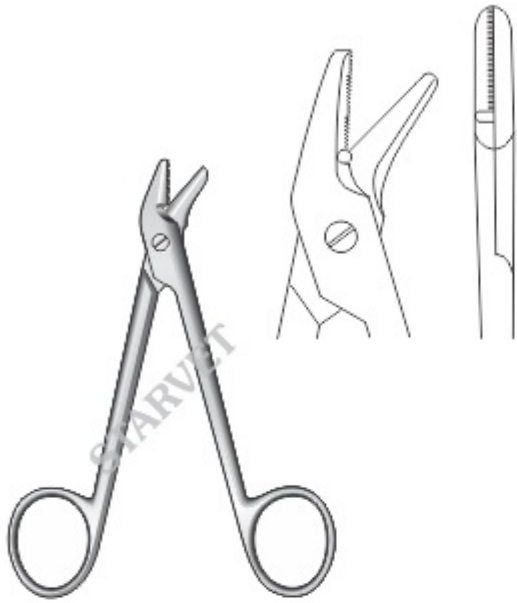

Universal  
ST02-0720 Serrated  
ST02-072 TC  
12 cm / 4 3/4"



Smith  
(Mod. USA)  
ST02-0730  
20 cm / 8"



ST02-0740  
21 cm / 8 1/2"



ST02-0750  
21 cm / 8 1/2"  
Enterotomy, postmortem and  
nail splitting scissors

These bandage scissors are also available in micro tone.  
One blade like knife and one ring Gold Plated, same numbers but with the addition (A).



ST02-0760 Black  
ST02-0761 Red  
ST02-0762 Blue  
ST02-0763 Yellow  
ST02-0764 Orange  
ST02-0765 Bright pink  
14.5 cm / 5 3/4"



ST02-0770 Black  
ST02-0771 Red  
ST02-0772 Blue  
ST02-0773 Yellow  
ST02-0774 Orange  
ST02-0775 Bright pink  
18 cm / 7"



**Knowles**  
ST02-0780 Straight  
ST02-0781 Angled  
14 cm / 5 1/2"  
ST02-0782 Angled  
19 cm / 7 1/2"



**Lister**  
ST02-0790 9 cm / 3 1/2" ST02-0791  
ST02-0792 11 cm / 4 1/2" ST02-0793  
ST02-0794 14 cm / 5 1/2" ST02-0795  
ST02-0796 16 cm / 6 1/4" ST02-0797  
ST02-0798 18 cm / 7" ST02-0799  
ST02-0800 20 cm / 8" ST02-0801  
Standard TC



**Lister Bandage Scissors**  
ST02-0810 14 cm / 5 1/2"  
ST02-0811 18 cm / 7"  
For left hand



**Bruns**  
ST02-0820 Plain  
23.5 cm / 9 1/4"  
ST02-0821 Serrated  
24 cm / 9 1/2"  
TC



Standard

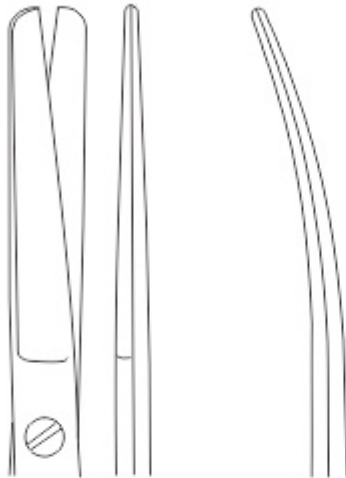

ST02-0830	14.5 cm / 5 1/4"	ST02-0831
ST02-0832	16 cm / 6 1/4"	ST02-0833
ST02-0834	18 cm / 7"	ST02-0835
TC		TC
ST02-0836	14.5 cm / 5 1/4"	ST02-0837
ST02-0838	16 cm / 6 1/4"	ST02-0839
ST02-0840	18 cm / 7"	ST02-0841
SC		SC
ST02-0842	14.5 cm / 5 1/4"	ST02-0843
ST02-0844	16 cm / 6 1/4"	ST02-0845
ST02-0846	18 cm / 7"	ST02-0847
SC/TC		SC/TC
Straight		Curved



Standard

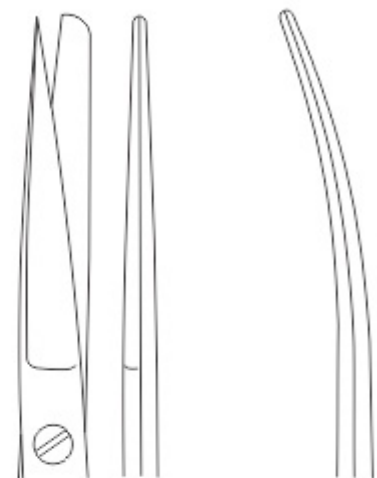

ST02-0860	14.5 cm / 5 1/4"	ST02-0861
ST02-0862	16 cm / 6 1/4"	ST02-0863
ST02-0864	18 cm / 7"	ST02-0865
TC		TC
ST02-0866	14.5 cm / 5 1/4"	ST02-0867
ST02-0868	16 cm / 6 1/4"	ST02-0869
ST02-0870	18 cm / 7"	ST02-0871
SC		SC
ST02-0872	14.5 cm / 5 1/4"	ST02-0873
ST02-0874	16 cm / 6 1/4"	ST02-0875
ST02-0876	18 cm / 7"	ST02-0877
SC/TC		SC/TC
Straight		Curved



Standard

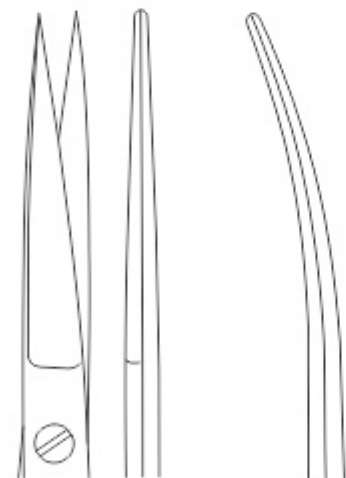

ST02-0890	14.5 cm / 5 1/4"	ST02-0891
ST02-0892	16 cm / 6 1/4"	ST02-0893
ST02-0894	18 cm / 7"	ST02-0895
TC		TC
ST02-0896	14.5 cm / 5 1/4"	ST02-0897
ST02-0898	16 cm / 6 1/4"	ST02-0899
ST02-0900	18 cm / 7"	ST02-0901
SC		SC
ST02-0902	14.5 cm / 5 1/4"	ST02-0903
ST02-0904	16 cm / 6 1/4"	ST02-0905
ST02-0906	18 cm / 7"	ST02-0907
SC/TC		SC/TC
Straight		Curved



Mayo

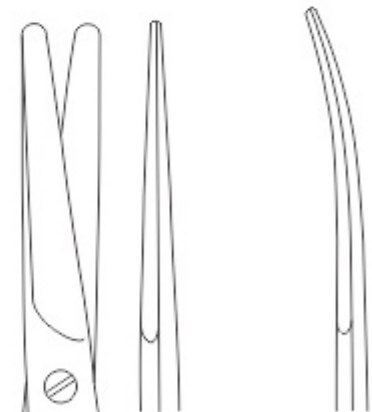

ST02-0920	14.5 cm / 5 1/4"	ST02-0921
ST02-0922	17 cm / 6 3/4"	ST02-0923
ST02-0924	23 cm / 9"	ST02-0925
TC		TC
ST02-0926	14.5 cm / 5 1/4"	ST02-0927
ST02-0928	17 cm / 6 3/4"	ST02-0929
ST02-0930	23 cm / 9"	ST02-0931
SC		SC
ST02-0932	14.5 cm / 5 1/4"	ST02-0933
ST02-0934	17 cm / 6 3/4"	ST02-0935
ST02-0936	23 cm / 9"	ST02-0937
SC/TC		SC/TC
Straight		Curved



Mayo-Stille

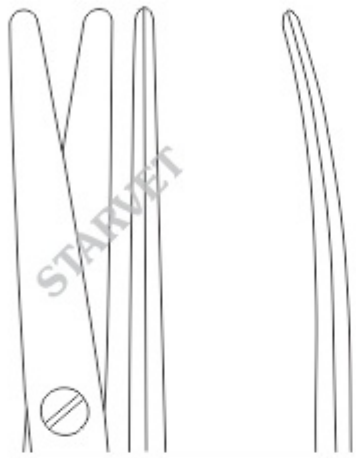

ST02-0950	15 cm / 6"	ST02-0951
ST02-0952	17 cm / 6 3/4"	ST02-0953
TC		TC
ST02-0954	15 cm / 6"	ST02-0955
ST02-0956	17 cm / 6 3/4"	ST02-0957
SC		SC
ST02-0958	15 cm / 6"	ST02-0959
ST02-0960	17 cm / 6 3/4"	ST02-0961
SC/TC		SC/TC
Straight		Curved



Lexer

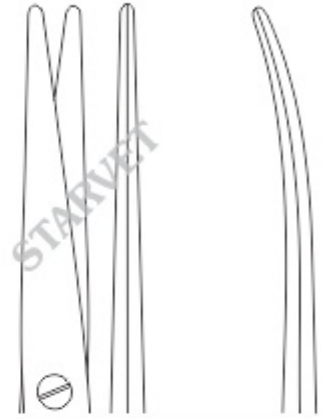

ST02-0970	16 cm / 6 1/2"	ST02-0971
ST02-0972	21 cm / 8 3/4"	ST02-0973
TC		TC
ST02-0974	16 cm / 6 1/2"	ST02-0975
ST02-0976	21 cm / 8 3/4"	ST02-0977
SC		SC
ST02-0978	16 cm / 6 1/2"	ST02-0979
ST02-0980	21 cm / 8 3/4"	ST02-0981
SC/TC		SC/TC
Straight		Curved



Mayo-Lexer  
16 cm / 6 1/4"

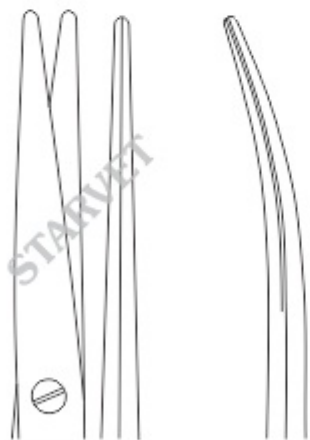

ST02-0990		ST02-0991
TC		TC
ST02-0992		ST02-0993
SC		SC
ST02-0994		ST02-0995
SC/TC		SC/TC
Straight		Curved



Metzbaum



ST02-1000	10 cm / 4"	ST02-1001
ST02-1002	12 cm / 4 3/4"	ST02-1003
TC		TC
ST02-1004	10 cm / 4"	ST02-1005
ST02-1006	12 cm / 4 3/4"	ST02-1007
SC		SC
ST02-1008	10 cm / 4"	ST02-1009
ST02-1010	12 cm / 4 3/4"	ST02-1011
SC/TC		SC/TC
Straight		Curved

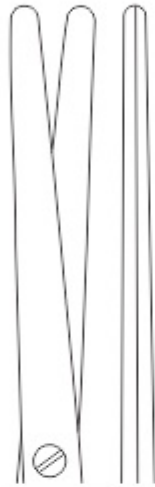

Metzenbaum  
Straight

ST02-1020	14.5 cm / 5¾"
ST02-1022	18 cm / 7"
ST02-1024	20 cm / 8"
ST02-1026	23 cm / 9"
ST02-1028	25 cm / 10"
ST02-1030	28 cm / 11"
ST02-1032	30 cm / 12"
TC	
ST02-1034	14.5 cm / 5¾"
ST02-1036	18 cm / 7"
ST02-1038	20 cm / 8"
ST02-1040	23 cm / 9"
ST02-1042	25 cm / 10"
ST02-1044	28 cm / 11"
ST02-1046	30 cm / 12"
SC	
ST02-1048	14.5 cm / 5¾"
ST02-1050	18 cm / 7"
ST02-1052	20 cm / 8"
ST02-1054	23 cm / 9"
ST02-1056	25 cm / 10"
ST02-1058	28 cm / 11"
ST02-1060	30 cm / 12"
ST02-1062	35 cm / 13¾"
SC/TC	



Metzenbaum  
Curved

ST02-1021	14.5 cm / 5¾"
ST02-1023	18 cm / 7"
ST02-1025	20 cm / 8"
ST02-1027	23 cm / 9"
ST02-1029	25 cm / 10"
ST02-1031	28 cm / 11"
ST02-1033	30 cm / 12"
TC	
ST02-1035	14.5 cm / 5¾"
ST02-1037	18 cm / 7"
ST02-1039	20 cm / 8"
ST02-1041	23 cm / 9"
ST02-1043	25 cm / 10"
ST02-1045	28 cm / 11"
ST02-1047	30 cm / 12"
SC	
ST02-1049	14.5 cm / 5¾"
ST02-1051	18 cm / 7"
ST02-1053	20 cm / 8"
ST02-1055	23 cm / 9"
ST02-1057	25 cm / 10"
ST02-1059	28 cm / 11"
ST02-1061	30 cm / 12"
ST02-1063	35 cm / 13¾"
SC/TC	





ST02-1080	14.5 cm / 5 3/4"	ST02-1081
ST02-1082	18 cm / 7"	ST02-1083
ST02-1084	20 cm / 8"	ST02-1085
ST02-1086	23 cm / 9"	ST02-1087
ST02-1088	25 cm / 10"	ST02-1089
ST02-1090	28 cm / 11"	ST02-1091
ST02-1092	30 cm / 12"	ST02-1093
TC		TC
ST02-1094	14.5 cm / 5 3/4"	ST02-1095
ST02-1096	18 cm / 7"	ST02-1097
ST02-1098	20 cm / 8"	ST02-1099
ST02-1100	23 cm / 9"	ST02-1101
ST02-1102	25 cm / 10"	ST02-1103
ST02-1104	28 cm / 11"	ST02-1105
ST02-1106	30 cm / 12"	ST02-1107
SC		SC
ST02-1108	14.5 cm / 5 3/4"	ST02-1109
ST02-1110	18 cm / 7"	ST02-1111
ST02-1112	20 cm / 8"	ST02-1113
ST02-1114	23 cm / 9"	ST02-1115
ST02-1116	25 cm / 10"	ST02-1117
ST02-1118	28 cm / 11"	ST02-1119
ST02-1120	30 cm / 12"	ST02-1121
SC/TC		SC/TC
Straight		Curved

ST02-1140	14 cm / 5 1/2"	ST02-1141
ST02-1142	16 cm / 6 1/4"	ST02-1143
ST02-1144	18 cm / 7"	ST02-1145
ST02-1146	20 cm / 8"	ST02-1147
ST02-1148	23 cm / 9"	ST02-1149
TC		TC
ST02-1150	14 cm / 5 1/2"	ST02-1151
ST02-1152	16 cm / 6 1/4"	ST02-1153
ST02-1154	18 cm / 7"	ST02-1155
ST02-1156	20 cm / 8"	ST02-1157
ST02-1158	23 cm / 9"	ST02-1159
SC		SC
ST02-1160	14 cm / 5 1/2"	ST02-1161
ST02-1162	16 cm / 6 1/4"	ST02-1163
ST02-1164	18 cm / 7"	ST02-1165
ST02-1166	20 cm / 8"	ST02-1167
ST02-1168	23 cm / 9"	ST02-1169
SC/TC		SC/TC
Straight		Curved



Metzenbaum-Fino  
Delicate



Metzenbaum-Fino

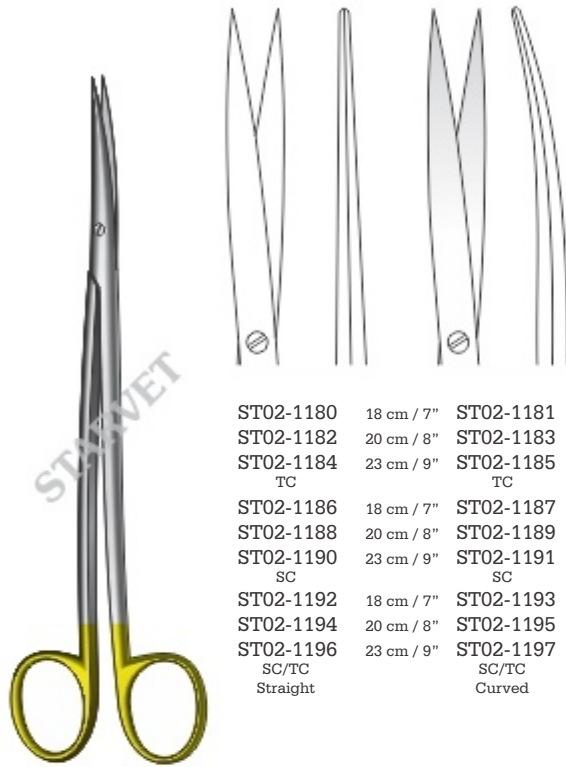

- |           |            |           |
|-----------|------------|-----------|
| ST02-1180 | 18 cm / 7" | ST02-1181 |
| ST02-1182 | 20 cm / 8" | ST02-1183 |
| ST02-1184 | 23 cm / 9" | ST02-1185 |
| TC        |            | TC        |
| ST02-1186 | 18 cm / 7" | ST02-1187 |
| ST02-1188 | 20 cm / 8" | ST02-1189 |
| ST02-1190 | 23 cm / 9" | ST02-1191 |
| SC        |            | SC        |
| ST02-1192 | 18 cm / 7" | ST02-1193 |
| ST02-1194 | 20 cm / 8" | ST02-1195 |
| ST02-1196 | 23 cm / 9" | ST02-1197 |
| SC/TC     |            | SC/TC     |
| Straight  |            | Curved    |

**Metzenbaum-Fino**  
S-Shape



- |           |
|-----------|
| ST02-1210 |
| TC        |
| ST02-1211 |
| SC        |
| ST02-1212 |
| SC/TC     |

**Toennis-Adson**  
17 cm / 6 1/2"



- |           |
|-----------|
| ST02-1220 |
| TC        |
| ST02-1221 |
| SC        |
| ST02-1222 |
| SC/TC     |

**Metzenbaum-Lahey**  
14.5 cm / 5 3/4"

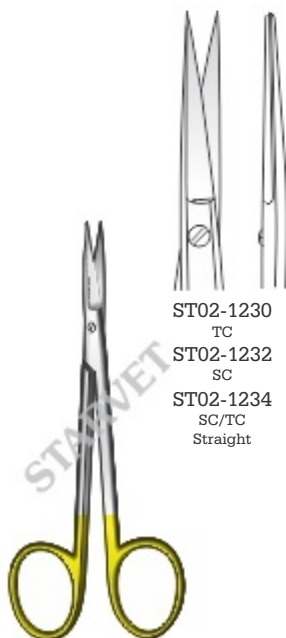

- |           |
|-----------|
| ST02-1230 |
| TC        |
| ST02-1232 |
| SC        |
| ST02-1234 |
| SC/TC     |
| Straight  |

**26** **Iris**  
11.5 cm / 4 1/2"



- |           |
|-----------|
| ST02-1231 |
| TC        |
| ST02-1233 |
| SC        |
| ST02-1235 |
| SC/TC     |
| Curved    |

**Strabismus**  
11.5 cm / 4 1/2"



- |               |
|---------------|
| ST02-1240     |
| 9 cm / 3 1/2" |
| Straight      |

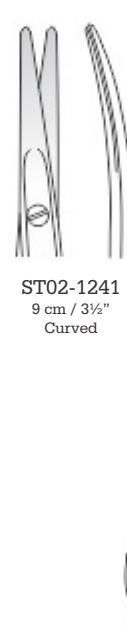

- |               |
|---------------|
| ST02-1241     |
| 9 cm / 3 1/2" |
| Curved        |



**ST02-1250**



**ST02-1255**



**Tick Forceps**  
ST02-1260  
12 cm / 4 1/4"



**English T.O.E**  
ST02-1270 12.5 cm / 5"  
ST02-1271 15 cm / 6"  
ST02-1272 18 cm / 7"  
ST02-1273 20 cm / 8"



**English**  
ST02-1280 12.5 cm / 5"  
ST02-1281 15 cm / 6"  
ST02-1282 18 cm / 7"  
ST02-1283 25 cm / 1"  
ST02-1284 30 cm / 12"  
ST02-1285 35 cm / 13 3/4"  
ST02-1286 40 cm / 15 3/4"



**Treves**  
ST02-1300 12.5 cm / 5" ST02-1301  
ST02-1302 15 cm / 6" ST02-1303  
ST02-1304 18 cm / 7" ST02-1305  
ST02-1306 25 cm / 10" ST02-1307  
ST02-1308 30 cm / 12" ST02-1309  
ST02-1310 35 cm / 13 3/4" ST02-1311  
ST02-1312 40 cm / 15 3/4" ST02-1313  
1:2 Teeth 2:3 Teeth



**Standard**  
ST02-1320 10 cm / 4"  
ST02-1322 11.5 cm / 4 1/2"  
ST02-1324 13 cm / 5"  
ST02-1326 14.5 cm / 5 1/2"  
ST02-1328 16 cm / 6 1/4"  
ST02-1330 18 cm / 7"  
ST02-1332 20 cm / 8"  
ST02-1334 23 cm / 9"  
ST02-1336 25 cm / 10"  
ST02-1338 30 cm / 12"  
ST02-1340 35 cm / 13 3/4"  
ST02-1342 40 cm / 15 3/4"  
ST02-1344 45 cm / 17"



**Standard Narrow**  
ST02-1321  
ST02-1323  
ST02-1325  
ST02-1327  
ST02-1329  
ST02-1331  
ST02-1333  
ST02-1335  
ST02-1337  
ST02-1339  
ST02-1341  
ST02-1343  
ST02-1345



**Tissue**  
ST02-1360 10 cm / 4"  
ST02-1362 11.5 cm / 4 1/2"  
ST02-1364 13 cm / 5"  
ST02-1366 14.5 cm / 5 1/2"  
ST02-1368 16 cm / 6 1/4"  
ST02-1370 18 cm / 7"  
ST02-1372 20 cm / 8"  
ST02-1374 23 cm / 9"  
ST02-1376 25 cm / 10"  
ST02-1378 30 cm / 12"  
ST02-1380 35 cm / 13 3/4"  
ST02-1382 40 cm / 15 3/4"  
ST02-1384 45 cm / 17"  
1:2 Teeth



**Tissue**  
ST02-1361  
ST02-1363  
ST02-1365  
ST02-1367  
ST02-1371  
ST02-1373  
ST02-1375  
ST02-1377  
ST02-1379  
ST02-1381  
ST02-1383  
ST02-1385  
2:3 Teeth



**Tissue**  
ST02-1400 13 cm / 5"  
ST02-1401 14.5 cm / 5½"  
ST02-1402 16 cm / 6¼"  
3:4 Teeth



**Tissue**  
ST02-1410 13 cm / 5"  
ST02-1411 14.5 cm / 5½"  
ST02-1412 16 cm / 6¼"  
4:5 Teeth



**USA Standard Model**  
ST02-1420 10 cm / 4"  
ST02-1421 13 cm / 5"  
ST02-1422 14.5 cm / 5½"  
ST02-1423 15.5 cm / 6"  
ST02-1424 18 cm / 7"  
ST02-1425 21 cm / 8¼"  
ST02-1426 25 cm / 10"  
ST02-1427 31 cm / 12¼"



**USA Standard Narrow**  
ST02-1440 12 cm / 4¾"  
ST02-1441 13 cm / 5"  
ST02-1442 14.5 cm / 5½"  
ST02-1443 15 cm / 6"



**USA Model**  
ST02-1450 12 cm / 4¾"  
ST02-1451 13 cm / 5"  
ST02-1452 14.5 cm / 5½"  
ST02-1453 15.5 cm / 6"  
ST02-1454 18 cm / 7"  
ST02-1455 21 cm / 8¼"  
ST02-1456 25 cm / 10"  
ST02-1457 31 cm / 12¼"  
1:2 Teeth



**Stille**  
ST02-1470  
15 cm / 6"



**Stille**  
ST02-1480  
15 cm / 6"  
2:3 Teeth



**Dressing Forceps**  
ST02-1490 13 cm / 5"  
ST02-1491 14.5 cm / 5½"  
ST02-1492 16 cm / 6¼"  
Cross Serrated



**Nugent**  
ST02-1496  
11 cm / 4¼"  
Serrated, Angled Tip at 45°  
Utility Forceps

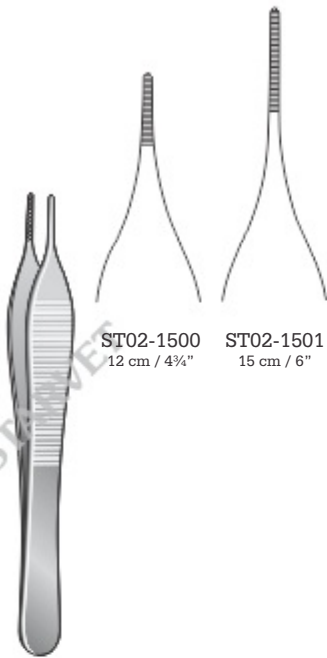

ST02-1500 12 cm / 4 3/4"  
ST02-1501 15 cm / 6"

Adson

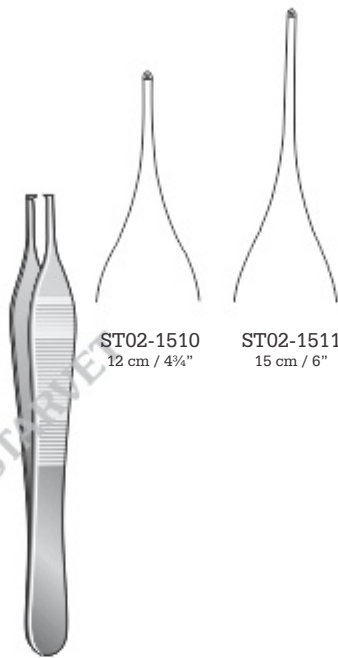

ST02-1510 12 cm / 4 3/4"  
ST02-1511 15 cm / 6"

Adson  
1:2 Teeth



McIndoe  
ST02-1520 Serrated  
ST02-1521 1:2 Teeth  
15 cm / 6"



Waugh  
ST02-1530 15 cm / 6"  
ST02-1532 18 cm / 7"  
ST02-1534 20 cm / 8"  
1:2 teeth  
Cross Serration Fine

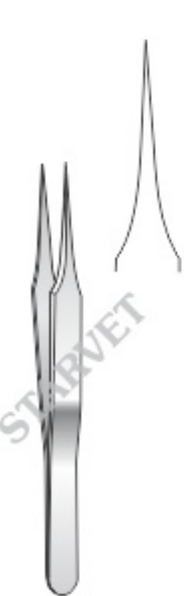

ST02-1540  
11 cm / 4 1/4"  
0.2 mm



Gillies  
ST02-1545  
15 cm / 6"  
1:2 Teeth



Lane  
ST02-1550 12.5 cm / 5"  
ST02-1552 14.5 cm / 5 1/2"  
ST02-1554 15 cm / 6"  
ST02-1556 18 cm / 7"  
ST02-1558 20 cm / 8"  
1:2 Teeth

ST02-1551  
ST02-1553  
ST02-1555  
ST02-1557  
ST02-1559  
2:3 Teeth



ST02-1570  
12.5 cm / 5"

ST02-1571  
15 cm / 6"

Semken



ST02-1580  
12.5 cm / 5"

ST02-1581  
15 cm / 6"

Semken  
1:2 Teeth



Micro-Adson  
ST02-1590  
12 cm / 4 3/4"



Micro-Adson  
12 cm / 4 3/4"  
ST02-1600  
With platform



Adson-Brown  
ST02-1610 12 cm / 4 3/4"  
ST02-1612 15 cm / 6"  
7:7 Teeth



ST02-1611  
ST02-1613  
9:9 Teeth



Adson-Brown  
ST02-1620 15 cm / 6"  
ST02-1621 18 cm / 7"



Iris  
11.5 cm / 4 1/2"



ST02-1630



ST02-1631



ST02-1632



ST02-1633  
1:2 Teeth



ST02-1634  
1:2 Teeth



ST02-1635  
1:2 Teeth



De Bakery  
ST02-1640  
Spay Forceps



ST02-1650  
Spay Forceps



ST02-1660 14 cm / 5 1/2"  
ST02-1663 15 cm / 6"  
Insemination Forceps

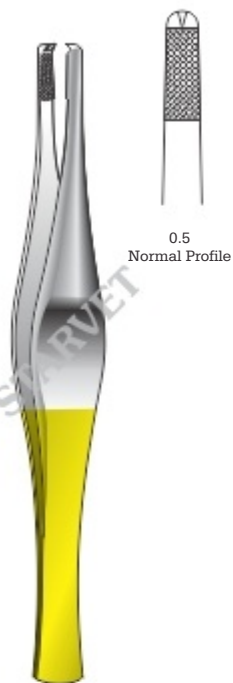

Ferris Smith  
ST02-1670  
18 cm / 7"



Mc Indoe  
ST02-1680  
15 cm / 6"



Gillies  
ST02-1690 14 cm / 5½"  
ST02-1693 15 cm / 6"

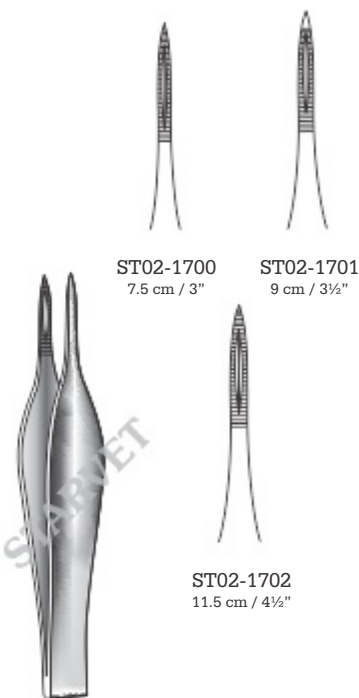

Feilchenfeld



College  
ST02-1710  
16 cm / 6¼"  
Fig. 2



Gerald  
17 cm / 6¾"  
Teeth 1:2



Potts-Smith



Bonney  
17 cm / 6¾"

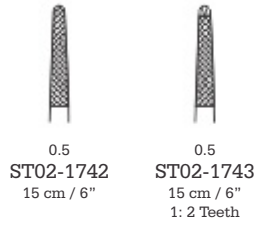
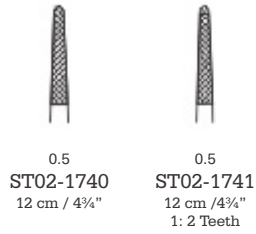

Adson  
Normal Profile

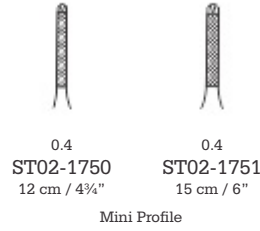

Micro Adson  
1: 2 Teeth



0.5  
Normal Profile

Adson Brown  
ST02-1760  
12 cm / 4 3/4"

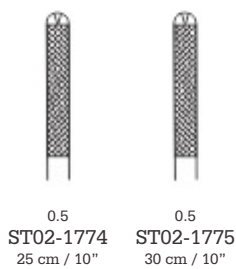
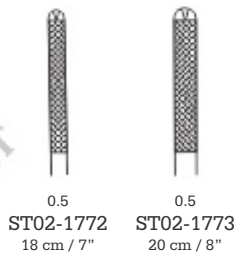
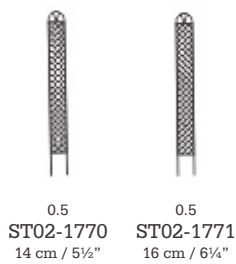

Oehler  
Normal Profile  
1: 2 Teeth



Standard  
Normal Profile



Denis-Browne  
ST02-1790  
18 cm / 7"



Young  
ST02-1800  
21 cm / 8 1/4"





ST02-1810  
3.5 cm / 1½"  
Straight



ST02-1820  
3.5 cm / 1½"  
Curved



ST02-1830  
4.5 cm / 1½"  
Straight



ST02-1840  
4.5 cm / 1½"  
Curved



Dieffenbach  
ST02-1850 3.8 cm / 1½"  
ST02-1852 4.8 cm / 2"  
Straight



Dieffenbach  
ST02-1851 3.8 cm / 1½"  
ST02-1853 4.8 cm / 2"  
Curved



Dieffenbach  
ST02-1870 5.8 cm / 2½"  
Straight



Dieffenbach  
ST02-1871 5.8 cm / 2½"  
Curved



Johns-Hopkins  
ST02-1880 5 cm / 2"  
ST02-1882 6.5 cm / 2½"  
ST02-1884 7.5 cm / 3"  
Straight



ST02-1881 5 cm / 2"  
ST02-1883 6.5 cm / 2½"  
ST02-1885 7.5 cm / 3"  
Curved



Splinter Forceps  
ST02-1890  
12 cm / 4¾"  
With magnifying glass



Halsted-Mosquito  
Normal

ST02-1900	9 cm / 3½"
ST02-1902	10 cm / 4"
ST02-1904	12 cm / 4¾"
ST02-1906	12.5 cm / 5"
ST02-1908	18 cm / 7"

Straight



ST02-1901
ST02-1903
ST02-1905
ST02-1907
ST02-1909

Curved



ST02-1920	9 cm / 3½"
ST02-1922	10 cm / 4"
ST02-1924	12 cm / 4¾"
ST02-1926	12.5 cm / 5"
ST02-1928	18 cm / 7"

Straight  
1:2 Teeth



ST02-1921
ST02-1923
ST02-1925
ST02-1927
ST02-1929

Curved  
1:2 Teeth



Micro-Mosquito  
Micro



ST02-1940	9 cm / 3½"
ST02-1942	10 cm / 4"
ST02-1944	12 cm / 4¾"

Straight



ST02-1941
ST02-1943
ST02-1945

Curved



ST02-1950	9 cm / 3½"
ST02-1952	10 cm / 4"
ST02-1954	12 cm / 4¾"

Straight  
1:2 Teeth



ST02-1951
ST02-1953
ST02-1955

Curved  
1:2 Teeth



**Kelly**  
14 cm / 5½"



ST02-1960  
Straight



ST02-1961  
Curved

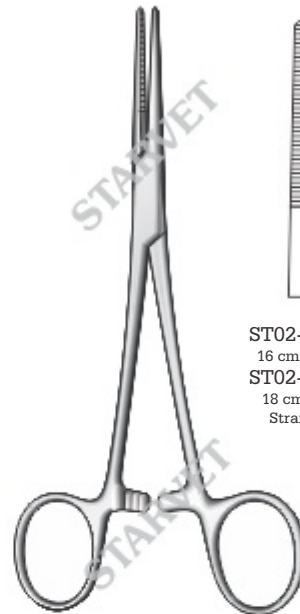

**Kelly-Rankin**



ST02-1970  
16 cm / 6¼"  
ST02-1972  
18 cm / 7"  
Straight



ST02-1971  
16 cm / 6¼"  
ST02-1973  
18 cm / 7"  
Curved



**Crile**  
14 cm / 5½"



ST02-1980  
Straight



ST02-1981  
Curved



ST02-1982  
Straight  
1:2 Teeth



ST02-1983  
Curved  
1:2 Teeth

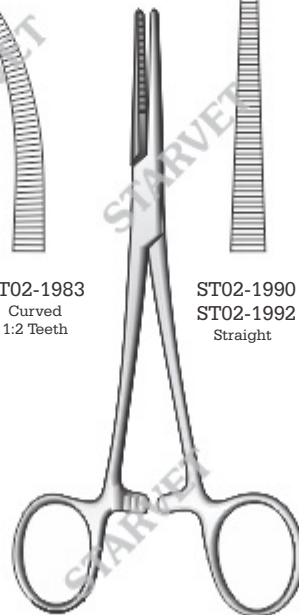

**Crile-Rankin**



ST02-1990  
16 cm / 6¼"  
ST02-1992  
18 cm / 7"  
Straight



ST02-1991  
ST02-1993  
Curved



ST02-1994  
ST02-1996  
Straight  
1:2 Teeth

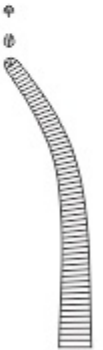

ST02-1995  
ST02-1997  
Curved  
1:2 Teeth



**Dandy**  
14 cm / 5½"  
Curved Side ways

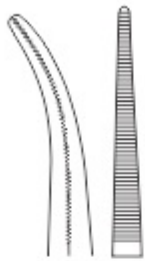

ST02-2010

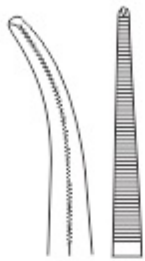

ST02-2011  
1:2 Teeth



**Leriche**  
15 cm / 6"



ST02-2020  
Straight



ST02-2021  
Curved



ST02-2022  
1:2 Teeth



ST02-2023  
1:2 Teeth

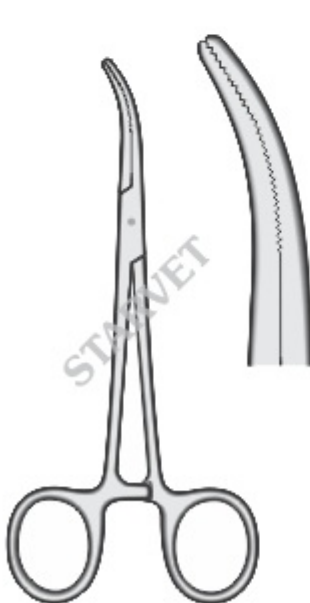

**Dandy Forceps**  
ST02-2030  
14 cm / 5½"  
Side Curved



**Christophe**  
16 cm / 6¼"



ST02-2040  
Straight



ST02-2041  
Curved



ST02-2042  
Straight  
1:2 Teeth



ST02-2043  
Curved  
1:2 Teeth

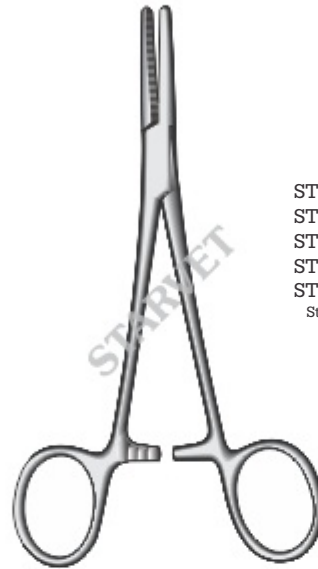

Spencer-Wells



ST02-2050  
ST02-2052  
ST02-2054  
ST02-2056  
ST02-2058  
Straight

12.5 cm / 5"  
15 cm / 6"  
18 cm / 7"  
20 cm / 8"  
23 cm / 9"



ST02-2051  
ST02-2053  
ST02-2055  
ST02-2057  
ST02-2059  
Curved



ST02-2070 13.5 cm / 5¼"  
ST02-2072 14.5 cm / 5¾"  
ST02-2074 17 cm / 6¾"  
Straight



ST02-2071  
ST02-2073  
ST02-2075  
Curved



Pean



ST02-2080 13 cm / 5"  
ST02-2082 14 cm / 5½"  
ST02-2084 16 cm / 6¼"  
Straight





ST02-2081  
ST02-2083  
ST02-2085  
Curved



Kocher  
1:2 Teeth





Rochester-Pean

		
ST02-2090	14 cm / 5½"	ST02-2091
ST02-2092	16 cm / 6¼"	ST02-2093
ST02-2094	18 cm / 7"	ST02-2095
ST02-2096	20 cm / 8"	ST02-2097
ST02-2098	22 cm / 8¾"	ST02-2099
ST02-2100	24 cm / 9½"	ST02-2101
ST02-2102	26 cm / 10½"	ST02-2103
ST02-2104	30 cm / 12"	ST02-2105
ST02-2106	35 cm / 13¾"	ST02-2107
	Straight	Curved



Rochester-Ochsner  
1:2 Teeth

		
ST02-2120	14 cm / 5½"	ST02-2121
ST02-2122	16 cm / 6¼"	ST02-2123
ST02-2124	18 cm / 7"	ST02-2125
ST02-2126	20 cm / 8"	ST02-2127
ST02-2128	22 cm / 8¾"	ST02-2129
ST02-2130	24 cm / 9½"	ST02-2131
ST02-2132	26 cm / 10½"	ST02-2133
ST02-2134	30 cm / 12"	ST02-2135
ST02-2136	35 cm / 13¾"	ST02-2137
	Straight	Curved

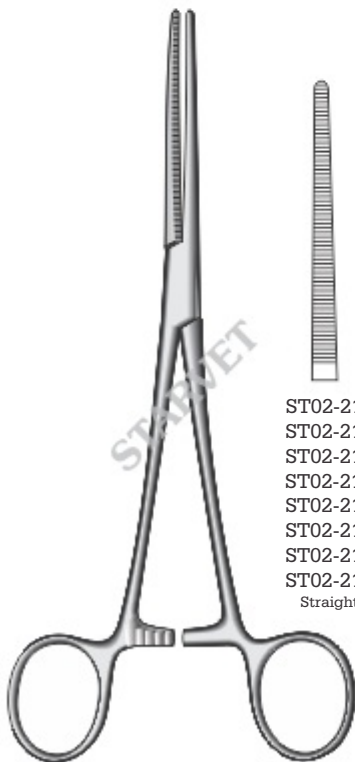

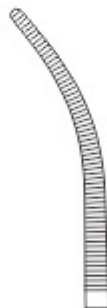

Rochester-Pean  
Delicate

		
ST02-2150	14 cm / 5½"	ST02-2151
ST02-2152	16 cm / 6¼"	ST02-2153
ST02-2154	18 cm / 7"	ST02-2155
ST02-2156	20 cm / 8"	ST02-2157
ST02-2158	22 cm / 8¾"	ST02-2159
ST02-2160	24 cm / 9½"	ST02-2161
ST02-2162	26 cm / 10½"	ST02-2163
ST02-2164	30 cm / 12"	ST02-2165
	Straight	Curved



Rochester-Ochsner  
Delicate  
1:2 Teeth

		
ST02-2170	14 cm / 5½"	ST02-2171
ST02-2172	16 cm / 6¼"	ST02-2173
ST02-2174	18 cm / 7"	ST02-2175
ST02-2176	20 cm / 8"	ST02-2177
ST02-2178	22 cm / 8¾"	ST02-2179
ST02-2180	24 cm / 9½"	ST02-2181
ST02-2182	26 cm / 10½"	ST02-2183
ST02-2184	30 cm / 12"	ST02-2185
	Straight	Curved



Rochester-Carmalt

ST02-2190  
ST02-2192  
ST02-2194  
Straight

12.5 cm / 5"  
16 cm / 6¼"  
20 cm / 8"

ST02-2191  
ST02-2193  
ST02-2195  
Curved



Brainbridge

ST02-2200  
ST02-2202  
Straight

15 cm / 6"  
18.5 cm / 7¼"

ST02-2201  
ST02-2203  
Curved

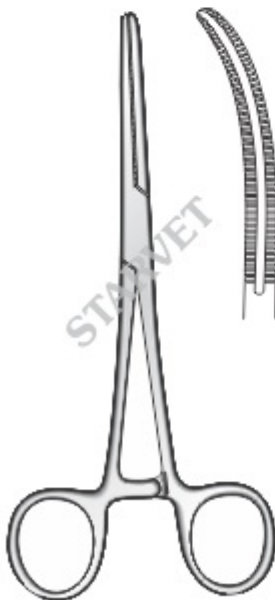

Angiotribes

ST02-2210 16 cm / 6½" ST02-2211  
ST02-2212 20 cm / 8" ST02-2213  
Straight Curved



Lane

ST02-2220 12.5 cm / 5"  
ST02-2222 15 cm / 6"  
ST02-2224 19 cm / 7½"  
1:2 Teeth

ST02-2221  
ST02-2223  
ST02-2225  
2:3 Teeth



Fergusson

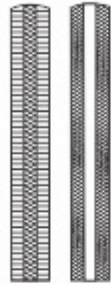

ST02-2230  
17 cm / 6 3/4"

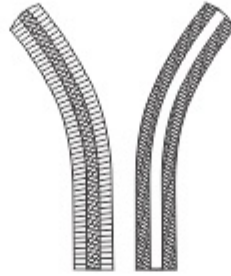

ST02-2231  
17 cm / 6 3/4"

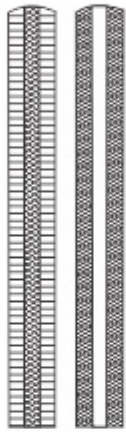

ST02-2232  
20 cm / 8"

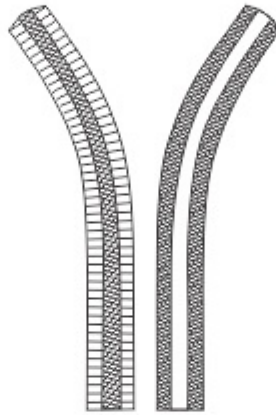

ST02-2233  
20 cm / 8"

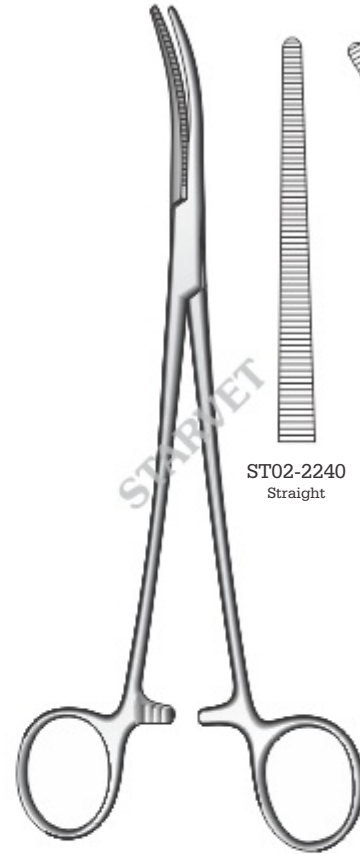

Roberts  
22 cm / 8 3/4"



ST02-2240  
Straight



ST02-2241  
Curved



Gemini



ST02-2250  
13 cm / 5"

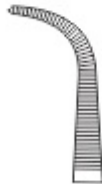

ST02-2251  
16 cm / 6 1/4"



ST02-2252  
18 cm / 7"

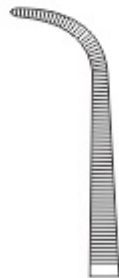

ST02-2253  
20 cm / 8"



ST02-2254  
23 cm / 9"

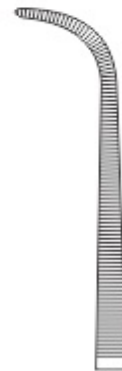

ST02-2255  
25 cm / 10"

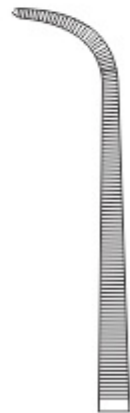

ST02-2256  
28 cm / 11"





ST02-2270  
Slightly  
Curved

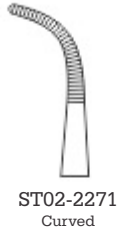

ST02-2271  
Curved

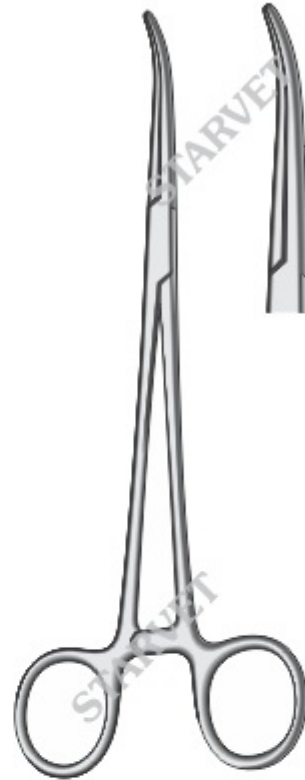

Mixer  
ST02-2280  
22 cm / 8 3/4"



Mixer

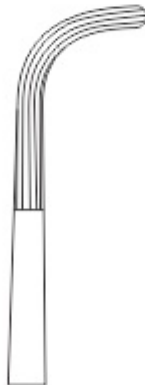

ST02-2290  
22 cm / 8 3/4"

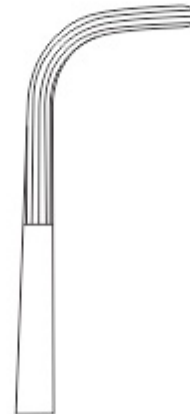

ST02-2291  
25 cm / 10"

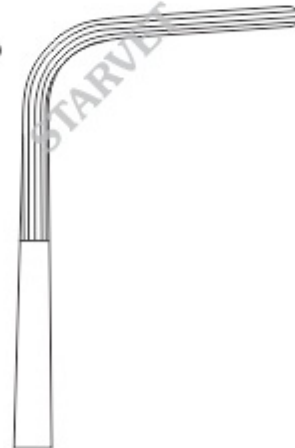

ST02-2292  
28 cm / 11"

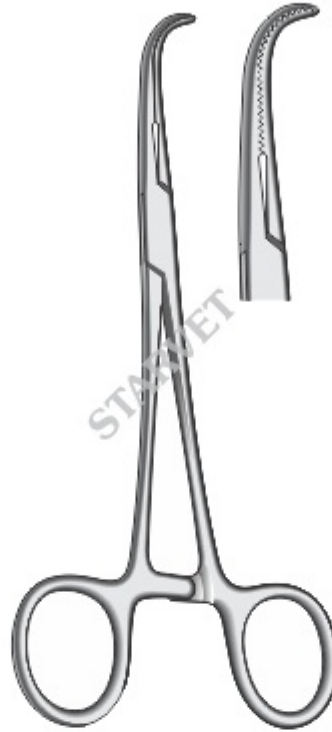

Cholecystectomy Clamps  
ST02-2300  
Right Angled Lahey  
19.5 cm / 7¾"



ST02-2310 16 cm / 6¼"  
ST02-2311 25 cm / 10"  
ST02-2312 30 cm / 12"  
ST02-2313 35 cm / 13¾"  
Small Right Angle Clamps  
Without Ratchet



ST02-2320 16 cm / 6¼"  
ST02-2321 25 cm / 10"  
ST02-2322 30 cm / 12"  
ST02-2323 35 cm / 13¾"  
Small Right Angle Clamps  
With Ratchet



Tonsillectomy Clamp  
ST02-2330 Right Angled  
ST02-2331 Curved  
19 cm / 7½"



ST02-2340  
45 Degree Curved  
22 cm / 8½"



ST 02-2350  
90 Degree Curved  
24.5 cm 9¾"





Babcock



Allis-Adair  
ST02-2430  
15 cm / 6"  
10:11 Teeth



Allis  
ST02-2440 15 cm / 6"  
ST02-2441 19 cm / 7½"  
ST02-2442 23 cm / 9"  
ST02-2443 25 cm / 10"  
ST02-2444 30 cm / 12"

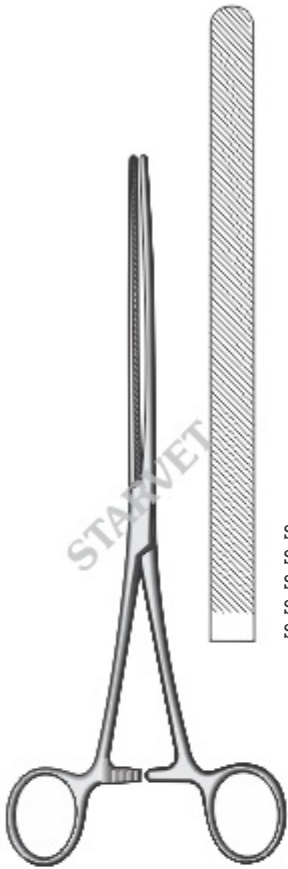

Doyen

- |           |             |
|-----------|-------------|
| ST02-2450 | 13 cm / 5"  |
| ST02-2452 | 15 cm / 6"  |
| ST02-2454 | 17 cm / 6¾" |
| ST02-2456 | 21 cm / 8¼" |
| ST02-2458 | 23 cm / 9"  |
- Straight

- |           |  |
|-----------|--|
| ST02-2451 |  |
| ST02-2453 |  |
| ST02-2455 |  |
| ST02-2457 |  |
| ST02-2459 |  |
- Curved



Mayo-Robson / Doyen

- |           |             |           |  |
|-----------|-------------|-----------|--|
| ST02-2470 | 13 cm / 5"  | ST02-2471 |  |
| ST02-2472 | 15 cm / 6"  | ST02-2473 |  |
| ST02-2474 | 17 cm / 6¾" | ST02-2475 |  |
| ST02-2476 | 21 cm / 8¼" | ST02-2477 |  |
| ST02-2478 | 24 cm / 9½" | ST02-2479 |  |
- Straight                      Curved



Kocher  
Very elastic

- |           |             |           |  |
|-----------|-------------|-----------|--|
| ST02-2490 | 22 cm / 8¾" | ST02-2491 |  |
| ST02-2492 | 25 cm / 10" | ST02-2493 |  |
| ST02-2494 | 28 cm / 11" | ST02-2495 |  |
- Straight                      Curved

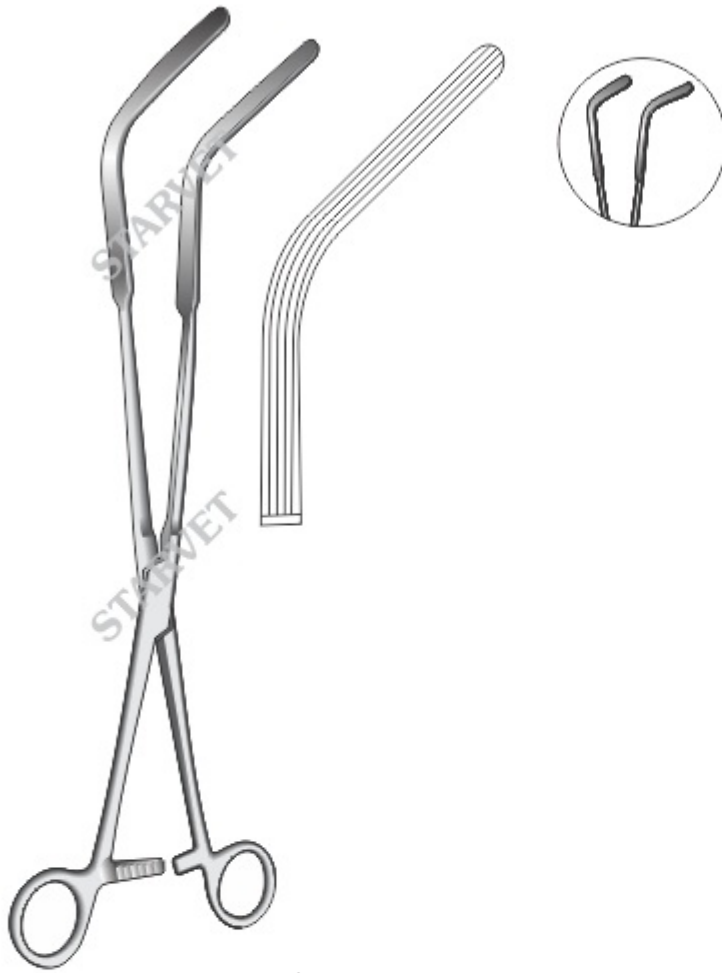

Resano Davis Bowel Clamp  
ST02-2500 25 cm / 10"  
ST02-2501 30 cm / 12"  
ST02-2502 35 cm / 14"

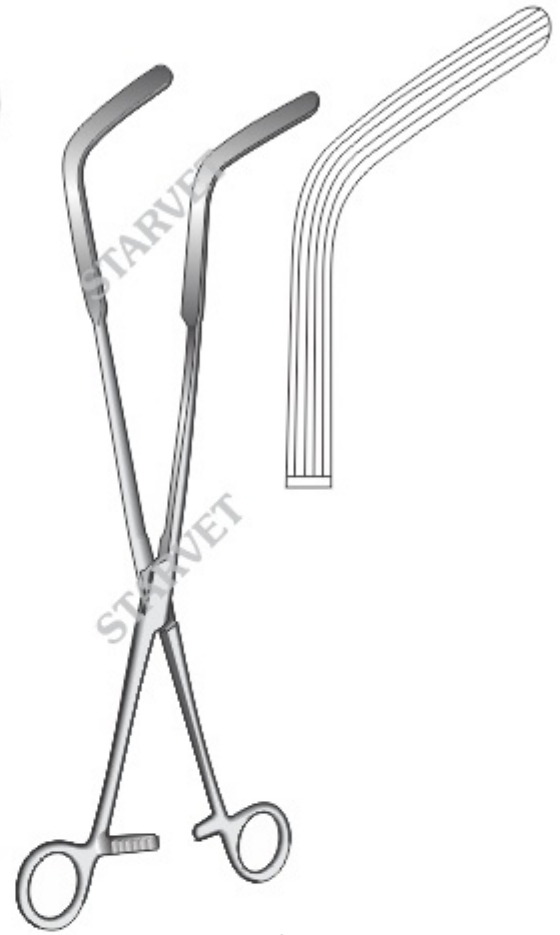

Resano Davis Bowel Clamp  
ST02-2510 25 cm / 10"  
ST02-2511 30 cm / 12"  
ST02-2512 35 cm / 14"  
Similar To The Resano In Style  
But With A Greater Angle On The Tips.



Spay Forceps  
ST02-2520



Spay Forceps  
ST02-2530

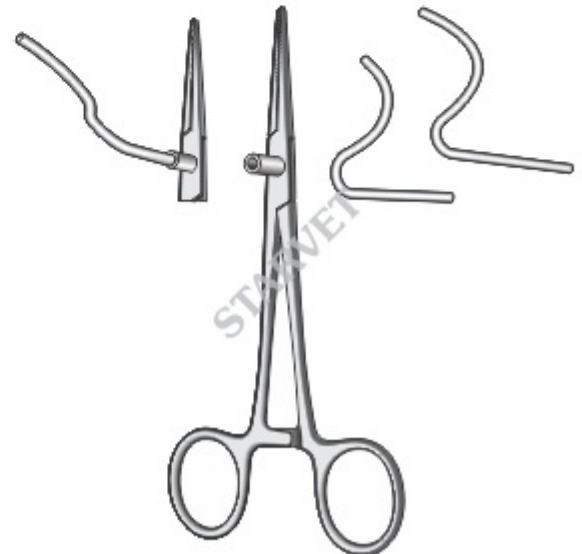

Spay Forceps  
ST02-2540  
With 2 levers



Foerster



ST02-2550  
ST02-2552  
ST02-2554  
Straight

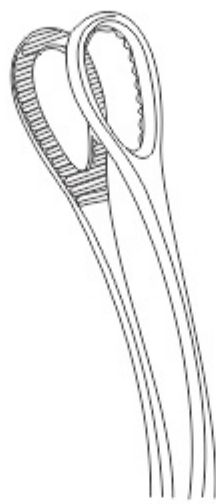

18 cm / 7"  
20 cm / 8"  
25 cm / 10"

ST02-2551  
ST02-2553  
ST02-2555  
Curved



Rambley



ST02-2560  
ST02-2562  
Box lock



18 cm / 7"  
25 cm / 10"

ST02-2561  
ST02-2563  
Screw lock





**Jones**  
ST02-2570 5 cm / 2"  
ST02-2571 9 cm / 3½"



**Schaedel**  
ST02-2580  
9 cm / 3½"



**English Model**  
ST02-2590  
9 cm / 3½"



**Backhaus**  
ST02-2600 9 cm / 3½"  
ST02-2601 11 cm / 4¼"  
ST02-2602 13 cm / 5¼"  
ST02-2603 15 cm / 6"  
ST02-2604 18 cm / 7"  
ST02-2605 20 cm / 8"  
Box Joint



**Roeder**  
ST02-2610 11 cm / 4¼"  
ST02-2611 13 cm / 5¼"  
ST02-2612 15 cm / 6"  
Box Joint



**Lorna**  
ST02-2620 10 cm / 4"  
ST02-2621 13 cm / 5"  
Box Joint

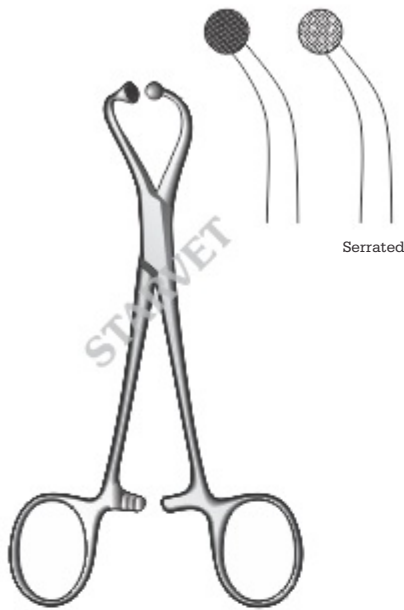

**Ball-Socket**  
ST02-2630 11 cm / 4½"  
ST02-2631 14 cm / 5½"  
For paper cloths  
ST02-2632 11 cm / 4½"  
ST02-2633 14 cm / 5½"  
Serrated



**Declaw Forceps**  
ST02-2640  
11 cm / 4½"  
ST02-2641  
13 cm / 5¼"



ST02-2650 14.5 cm / 5¾"  
ST02-2651 16 cm / 6¼"  
ST02-2652 18 cm / 7"

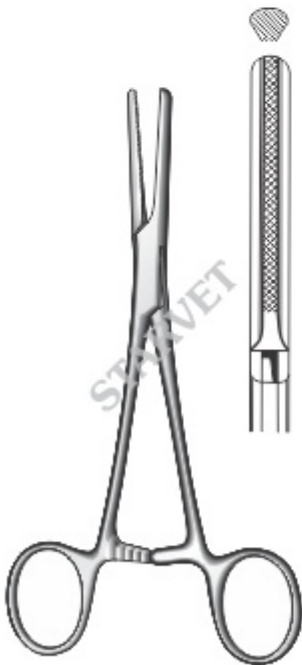

**Standard**  
ST02-2660 14 cm / 5½"  
ST02-2661 15 cm / 6"  
ST02-2662 18 cm / 7"  
ST02-2663 20 cm / 8"



ST02-2670  
Staple Remover

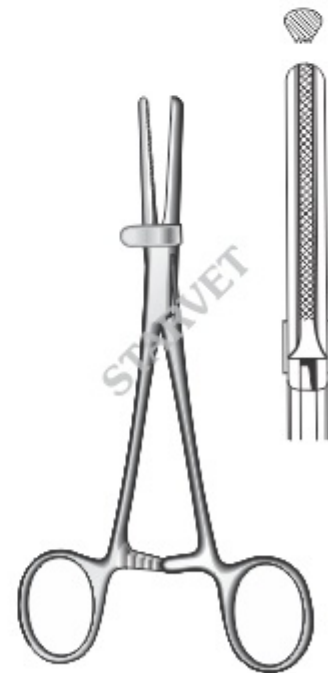

ST02-2680 14 cm / 5½"  
ST02-2681 15 cm / 6"  
ST02-2682 18 cm / 7"  
ST02-2683 20 cm / 8"  
with guard



Hobday Forceps  
ST02-2690  
14 cm / 5½"

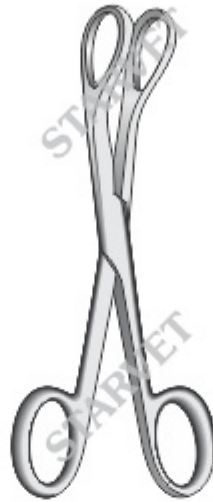

Hobday  
ST02-2700  
14 cm / 5½"



Danish Model  
ST02-2710  
20 cm / 8"



Hobday  
ST02-2720  
21 cm / 8¼"



McLean  
ST02-2730 20 cm / 8"  
ST02-2731 25 cm / 10"  
ST02-2732 30 cm / 12"

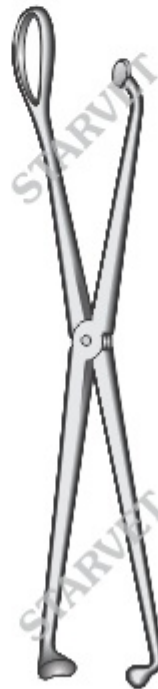

ST02-2740  
35 cm / 13¾"



Witt / Gehrt  
ST02-2750  
52 cm / 20½"

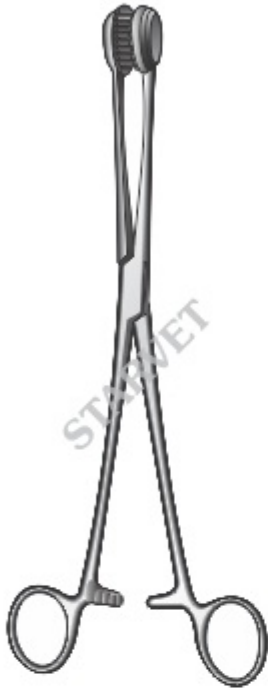

Child  
ST02-2760  
24 cm / 9½"

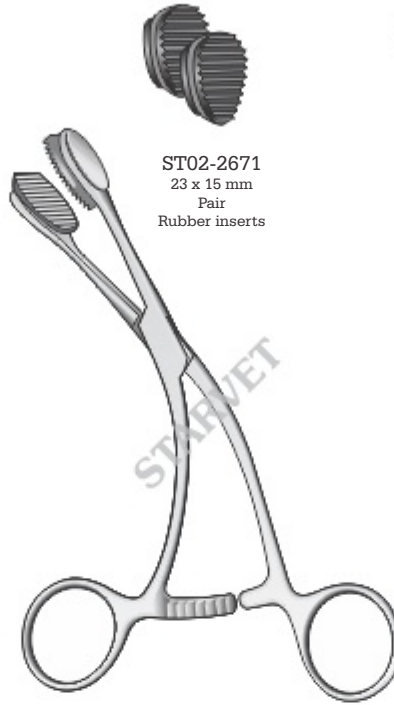

ST02-2671  
23 x 15 mm  
Pair  
Rubber inserts

Young  
ST02-2770  
17 cm / 6¾"

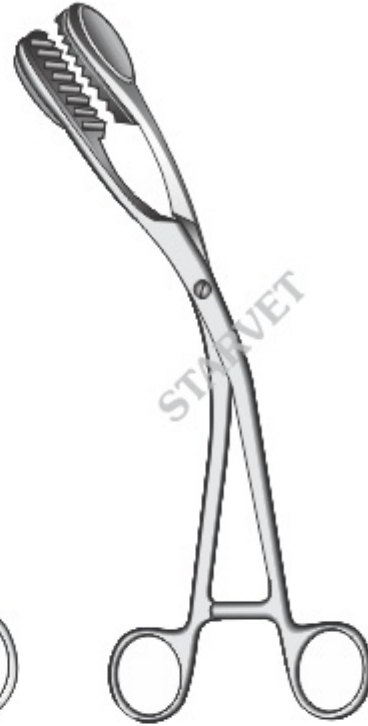

ST02-2780 30 cm / 11¾"  
ST02-2781 27 cm / 10¾"  
Uterine Holding

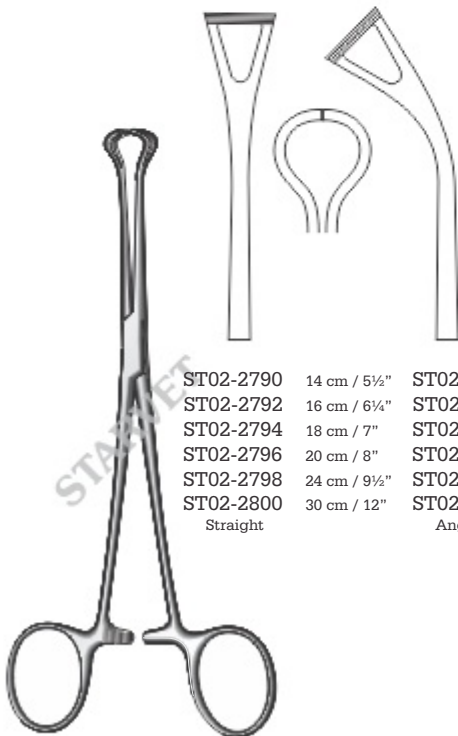

ST02-2790	14 cm / 5½"	ST02-2791
ST02-2792	16 cm / 6¼"	ST02-2793
ST02-2794	18 cm / 7"	ST02-2795
ST02-2796	20 cm / 8"	ST02-2797
ST02-2798	24 cm / 9½"	ST02-2799
ST02-2800	30 cm / 12"	ST02-2801
Straight		Angled

Babcock  
Straight



Obstetric Forceps  
ST02-2810



Vectis  
ST02-2820  
Double ended



Danish Model  
ST02-2830 For bitches  
23 cm / 9"  
ST02-2831 For sheep  
60 cm / 23½"

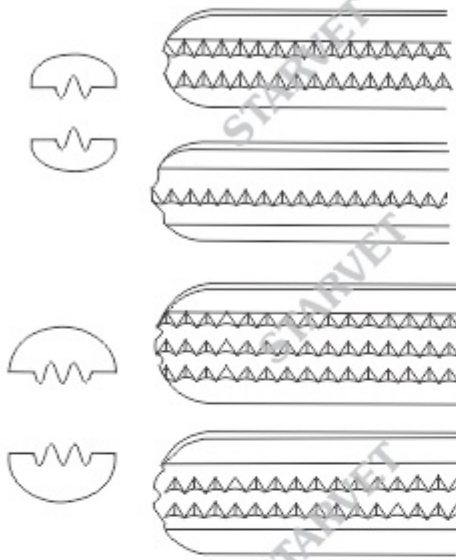

**Toothing according to De Bakey:**  
The traditional ATRAUMA clamps. Apart from Cardio-Vascular Surgery, These are also approved for other atraumatic applications and surgery techniques. Firm and precise seizing of tissues, Safe and delicately controlled clamping effect.



**Adson DeBakey**  
ST02-2840 12 cm / 4 3/4"  
ST02-2841 15 cm / 6"



**De Bakey**  
ST02-2850 16 cm / 6 1/4"  
ST02-2851 20 cm / 8"

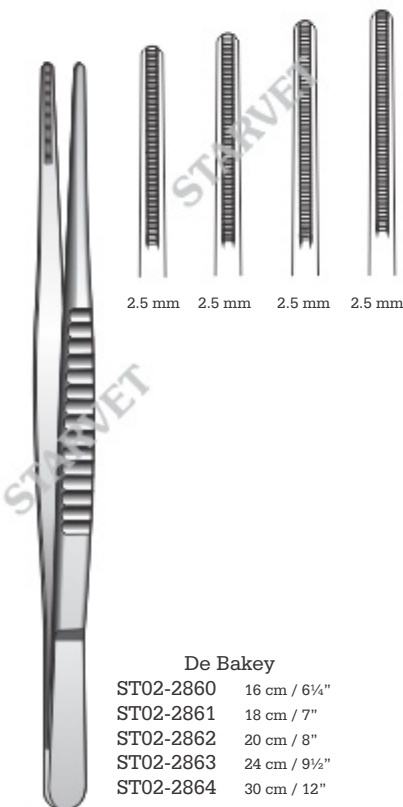

**De Bakey**  
ST02-2860 16 cm / 6 1/4"  
ST02-2861 18 cm / 7"  
ST02-2862 20 cm / 8"  
ST02-2863 24 cm / 9 1/2"  
ST02-2864 30 cm / 12"

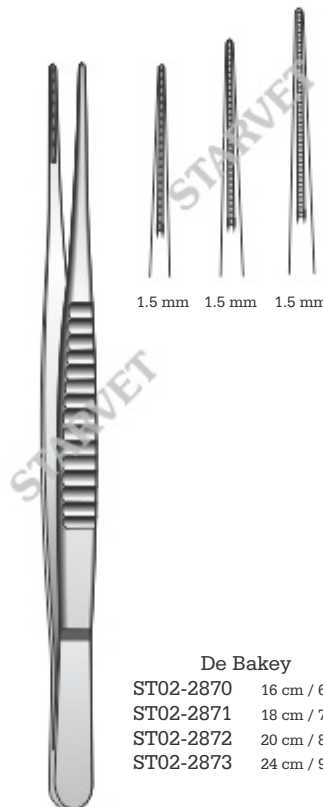

**De Bakey**  
ST02-2870 16 cm / 6 1/4"  
ST02-2871 18 cm / 7"  
ST02-2872 20 cm / 8"  
ST02-2873 24 cm / 9 1/2"

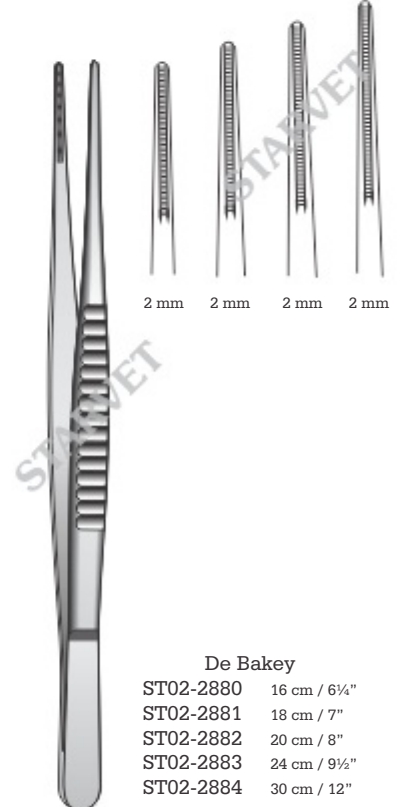

**De Bakey**  
ST02-2880 16 cm / 6 1/4"  
ST02-2881 18 cm / 7"  
ST02-2882 20 cm / 8"  
ST02-2883 24 cm / 9 1/2"  
ST02-2884 30 cm / 12"

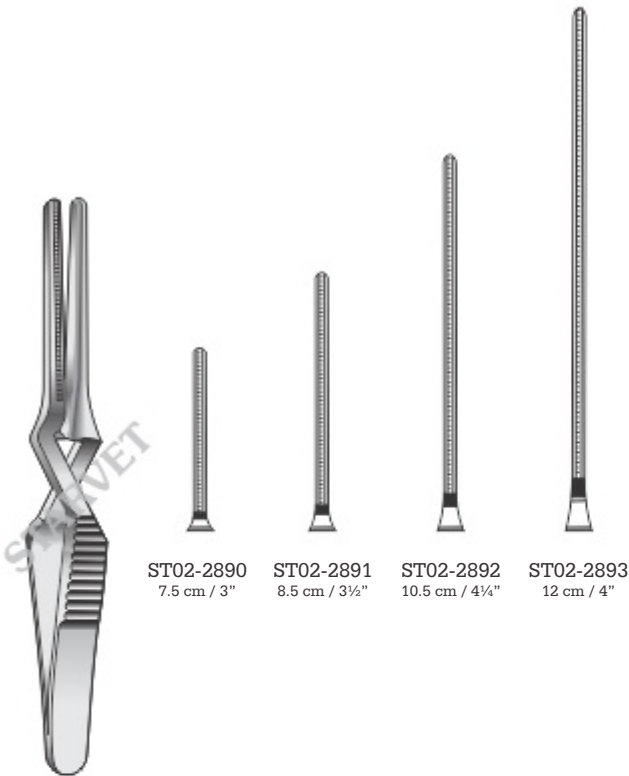

ST02-2890 7.5 cm / 3"  
ST02-2891 8.5 cm / 3½"  
ST02-2892 10.5 cm / 4¼"  
ST02-2893 12 cm / 4"

De Bakey  
straight

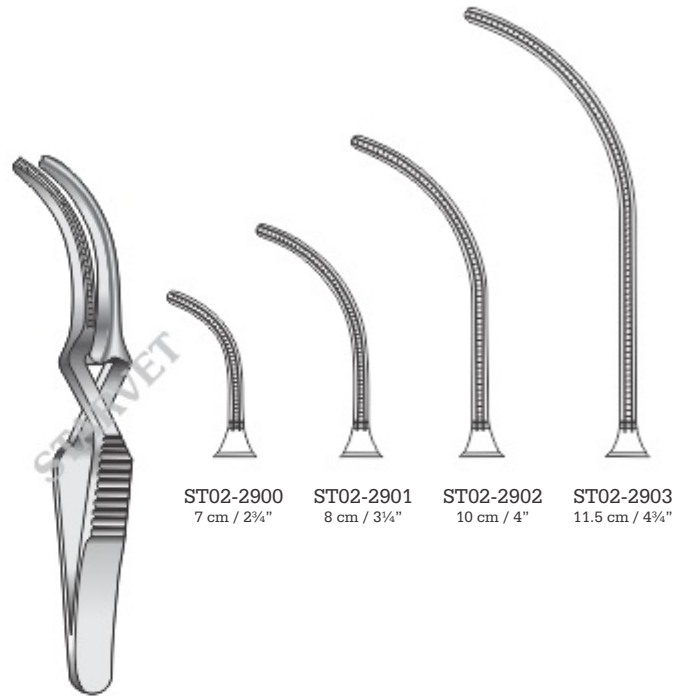

ST02-2900 7 cm / 2¾"  
ST02-2901 8 cm / 3¼"  
ST02-2902 10 cm / 4"  
ST02-2903 11.5 cm / 4½"

De Bakey  
Curved

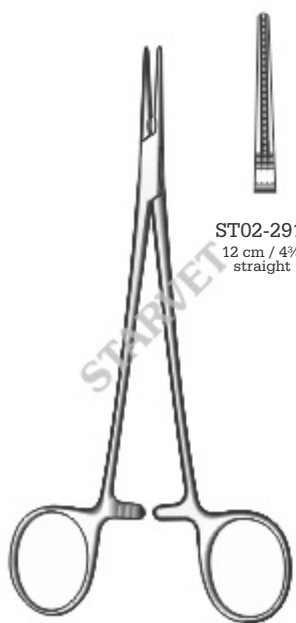

De Bakey-Mosquito

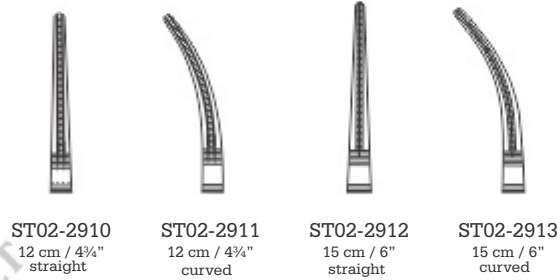

ST02-2910 12 cm / 4¾" straight  
ST02-2911 12 cm / 4¾" curved  
ST02-2912 15 cm / 6" straight  
ST02-2913 15 cm / 6" curved

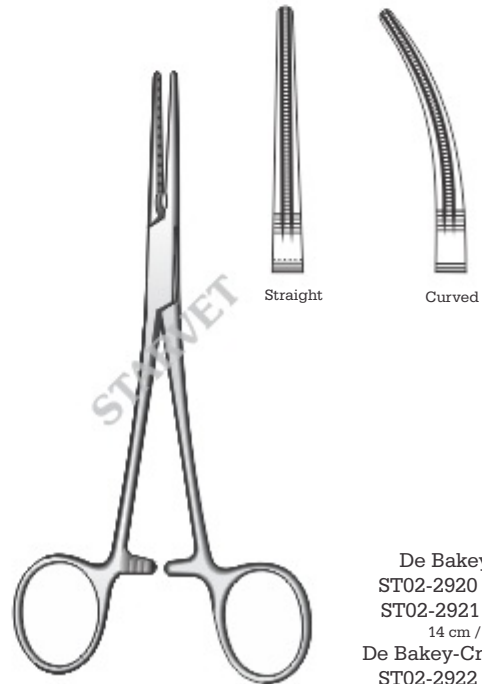

De Bakey-Crile  
ST02-2920 Straight  
ST02-2921 Curved  
14 cm / 5½"  
De Bakey-Crile-Rankin  
ST02-2922 Straight  
ST02-2923 Curved  
16 cm / 6¼"



Bowl Clamps



ST02-2930  
ST02-2932  
ST02-2934  
ST02-2936  
ST02-2938  
ST02-2940  
ST02-2942  
Straight



13 cm / 5"  
16 cm / 6¼"  
18 cm / 7"  
21 cm / 8¼"  
23 cm / 9"  
26 cm / 10¼"  
28 cm / 11"  
ST02-2931  
ST02-2933  
ST02-2935  
ST02-2937  
ST02-2939  
ST02-2941  
ST02-2943  
Curved



Allis-Atrauma



ST02-2950  
16 cm / 6¼"



ST02-2951  
20 cm / 8"



ST02-2952  
25 cm / 10"



ST02-2953  
30 cm / 12"



Babcock-Atrauma



ST02-2960  
16 cm / 6¼"



ST02-2961  
20 cm / 8"

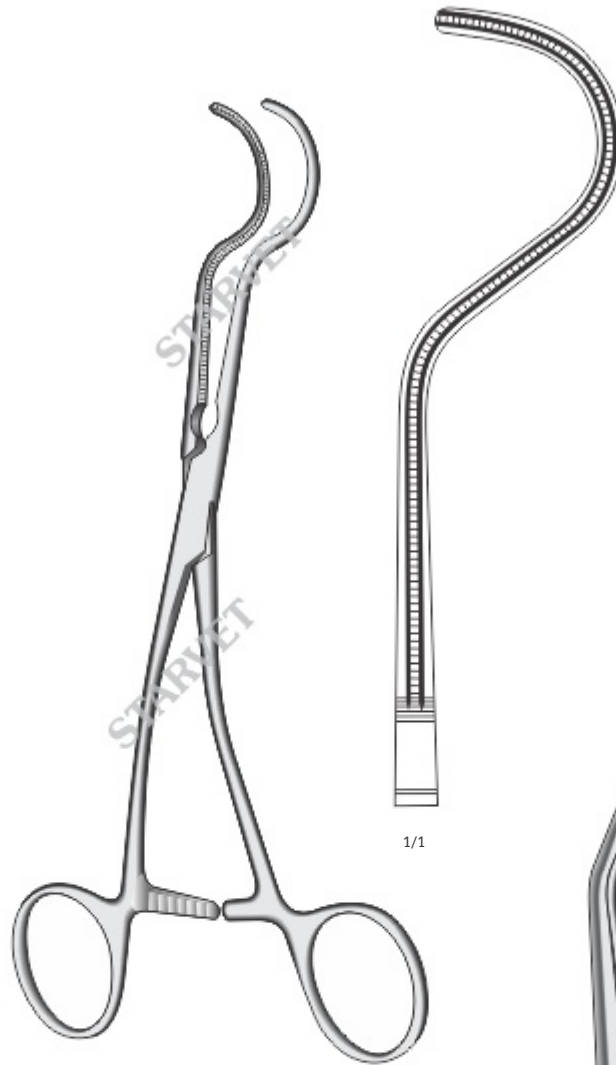

DeBakey  
ST02-2970 14 cm / 5½"  
ST02-2971 17.5 cm / 7"



Soft Palate Clamps  
ST02-2980 26 x 12 mm, Large  
ST02-2981 18 x 7 mm, Small  
17 cm / 6¾"

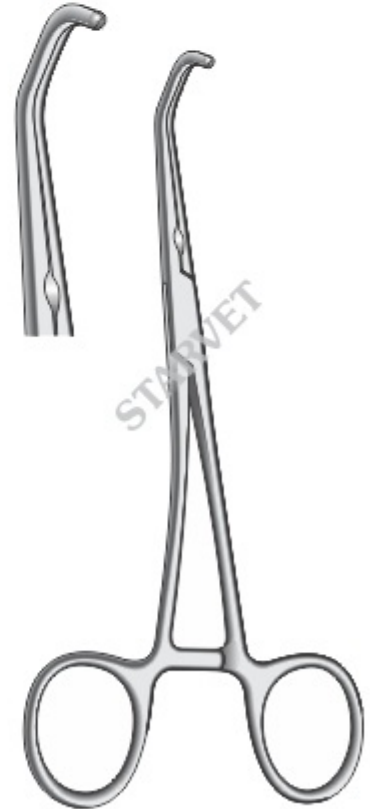

Satinsky Clamps  
ST02-2990 30 mm Jaw  
20 cm / 8"  
ST02-2991 20 mm Jaw  
16 cm / 6¼"



Weingart's Stomach Operating Set  
(for removing foreign bodies from the rumen)

- ST02-3000  
Complete Set  
Containing
- Valsellum forceps x 2
  - Fixation frame x 1
  - fixation teneculums x 8



ST02-3010  
Valsellum  
24 cm



ST02-3011  
Fixation Teneculums  
8 cm



ST02-3012  
Fixation Frame  
28 cm

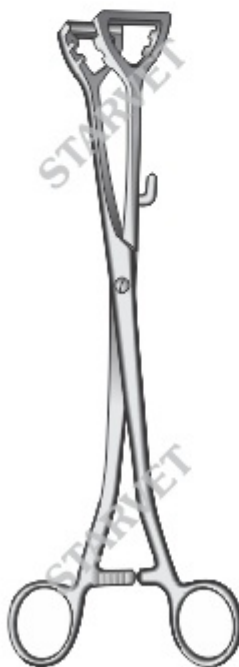

ST02-3020 with hook  
ST02-3021 without hook  
20 cm / 8"



Bovina Cervical  
ST02-3030  
54 cm / 21"

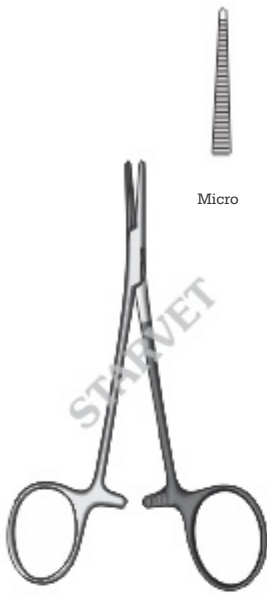

Micro-Mosquito  
ST02-3040  
10 cm / 4"  
For Left Hand



Halsted-Mosquito  
For Left Hand



ST02-3050  
ST02-3052  
ST02-3054  
Straight

12.5 cm / 5"  
10 cm / 4"  
12 cm / 4 3/4"



ST02-3051  
ST02-3053  
ST02-3055  
Curved



Kelly  
14 cm / 5 1/2"  
For Left Hand

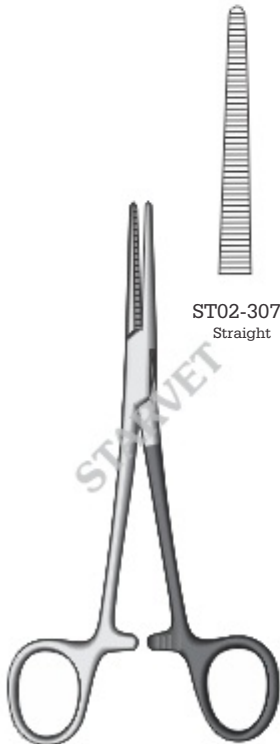

Crile  
14 cm / 5 1/2"  
For Left Hand

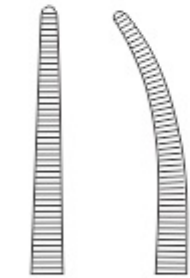

Rochester-Pean  
For Left Hand



14 cm / 5 1/2"  
16 cm / 6 1/4"



Rochester-Carmalt  
16 cm / 6 1/4"  
For Left Hand





ST02-3100  
Straight

ST02-3101  
Curved

Standard  
14.5 cm / 5½"  
Sharp / Sharp  
For Left Hand



ST02-3110  
Straight

ST02-3111  
Curved

Standard  
14.5 cm / 5½"  
Blunt / Blunt  
For Left Hand



Sharp / Blunt

Standard  
ST02-3120  
14.5 cm / 5½"  
Straight  
For Left Hand

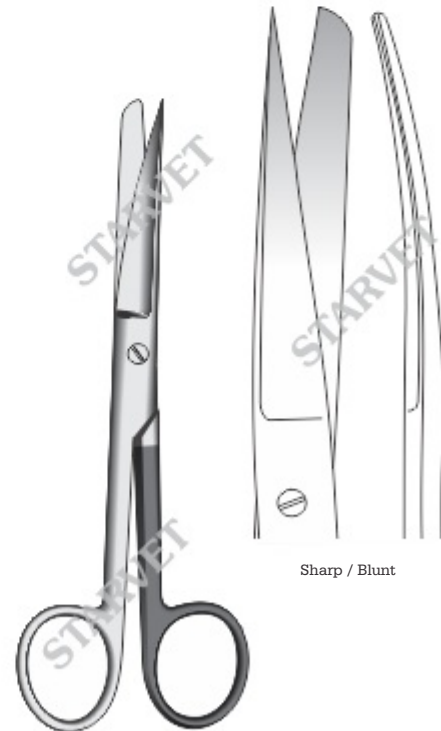

Sharp / Blunt

Standard  
ST02-3130  
14.5 cm / 5½"  
Curved  
For Left Hand



Metzenbaum  
ST02-3140  
15 cm / 6"  
For Left Hand



Mayo  
For Left Hand

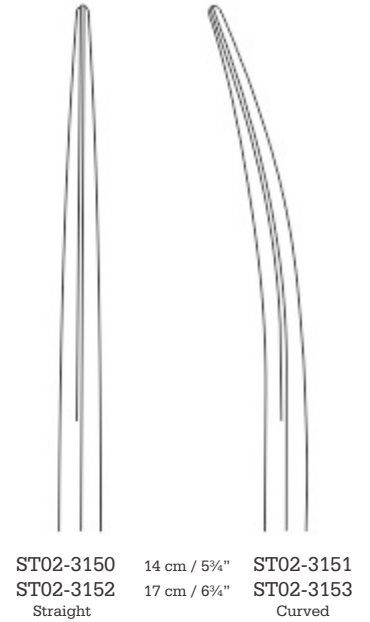

ST02-3150	14 cm / 5 1/4"	ST02-3151
ST02-3152	17 cm / 6 3/4"	ST02-3153
Straight		Curved

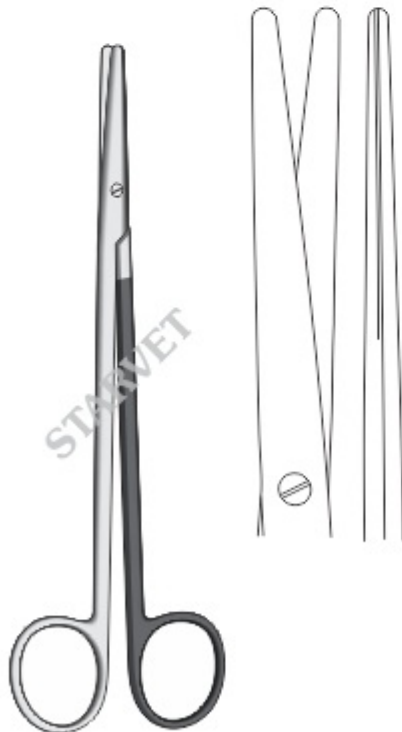

Metzenbaum  
ST02-3160 18 cm / 7"  
ST02-3161 20 cm / 8"  
Straight  
For Left Hand



Metzenbaum  
ST02-3170 18 cm / 7"  
ST02-3171 20 cm / 8"  
Curved  
For Left Hand

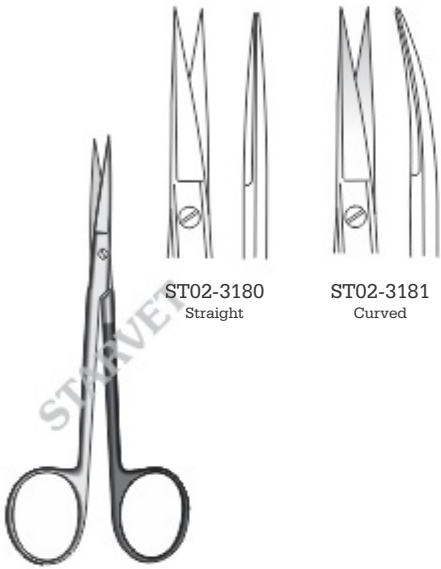

Iris  
For Left Hand  
11.5 cm / 4½"  
Round

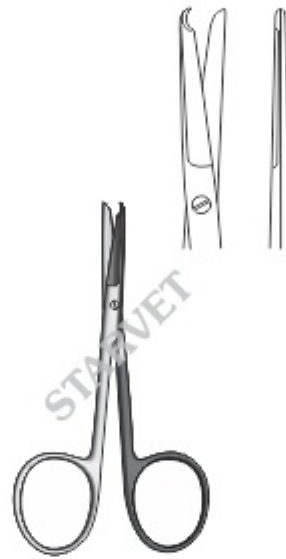

Spencer  
ST02-3190  
Normal  
9 cm / 3½"  
For Left Hand



Littauer  
ST02-3200  
14 cm / 5½"  
For Left Hand



ST02-3210  
18 cm / 7"  
For Left Hand



Lister Bandage Scissors  
ST02-3220  
14 cm / 5½"  
For Left Hand



Smooth jaws

Halsey  
ST02-3230  
12.5 cm / 5"  
For Left Hand



Derf  
ST02-3240  
12.5 cm / 5"  
For Left Hand



ST02-3250  
Smooth Jaws

ST02-3251  
Serrated Jaws

Webster  
13 cm / 5"  
Delicate  
For Left Hand



Collier  
ST02-3260  
12.5 cm / 5"  
For Left Hand



ST02-3270  
ST02-3272  
16 cm / 6¼"

Standard  
TC

ST02-3271  
ST02-3273  
18 cm / 7"

Mayo-Hegar  
For Left Hand



**Backhaus**  
ST02-3280 9 cm / 3½"  
ST02-3281 13 cm / 5¼"  
ST02-3282 15 cm / 6"  
Box Joint  
For Left Hand



**Allis**  
ST02-3290  
15 cm / 6"  
4:5 Teeth  
For Left Hand



**Olsen-Hegar**  
ST02-3300  
14 cm / 5½"  
For Left Hand



**Olsen-Hegar**  
ST02-3310 14 cm / 5½"  
ST02-3311 16 cm / 6¼"  
ST02-3312 18 cm / 7"  
For Left Hand



**Olsen-Hegar**  
ST02-3320 14 cm / 5½"  
ST02-3321 16 cm / 6¼"  
ST02-3322 18 cm / 7"  
TC  
For Left Hand

Fig. 2 30 x 10 mm  
Fig. 1 30 x 13 mm



Fig. 1 26 x 10 mm  
Fig. 2 34 x 13 mm

**Farabeuf**  
ST02-3330  
12 cm / 4 3/4"  
Set of 2

Fig. 2 27 x 16 mm  
Fig. 1 26 x 16 mm



Fig. 1 23 x 16 mm  
Fig. 2 30 x 16 mm

**Farabeuf**  
ST02-3340  
15 cm / 6"  
Set of 2

Fig. 2 21 x 14 mm  
Fig. 1 17 x 14 mm



Fig. 1 28 x 16 mm  
Fig. 2 32 x 16 mm

**Collin**  
ST02-3350  
15 cm / 6"  
Set of 2

11 x 4 mm



19 x 6 mm

**Crile**  
ST02-3360  
11 cm / 4 1/4"



**Mini-Roux**  
ST02-3370  
14 cm / 5 1/2"

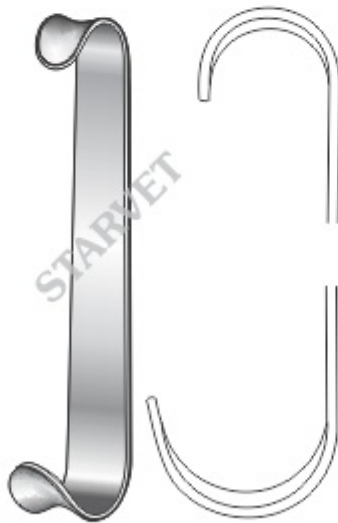

**Baby-Roux**  
ST02-3380  
13 cm / 5 1/4"



**Roux**  
ST02-3390 Set of 4  
ST02-3391 14 cm / 5 1/2"  
ST02-3392 15 cm / 6"  
ST02-3393 17 cm / 6 3/4"  
ST02-3394 18 cm / 7"

Fig. 2 22 x 15 mm  
Fig. 1 19 x 15 mm



Fig. 1 19 x 15 mm  
Fig. 2 22 x 15 mm

**Parker**  
ST02-3400  
Set of 2



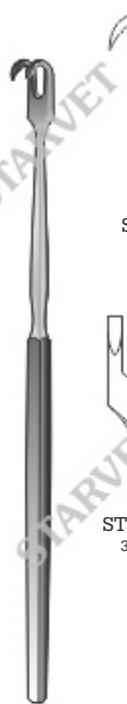

ST02-3410  
1 Prong



ST02-3411  
2 Prongs



ST02-3412  
3 Prongs



ST02-3413  
4 Prongs

16 cm / 6 1/4"  
Sharp



ST02-3420  
1 Prong



ST02-3421  
2 Prongs



ST02-3422  
3 Prongs



ST02-3423  
4 Prongs

16 cm / 6 1/4"  
Blunt



ST02-3430  
1 Prongs



ST02-3431  
2 Prongs



ST02-3432  
3 Prongs



ST02-3433  
4 Prongs

16 cm / 6 1/4"  
Sharp



ST02-3440  
1 Prongs



ST02-3441  
2 Prongs



ST02-3442  
3 Prongs



ST02-3443  
4 Prongs

16 cm / 6 1/4"  
Blunt



ST02-3450  
2 Prongs

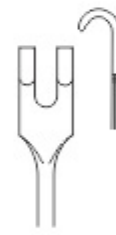
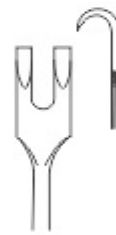

ST02-3451  
2 Prongs



ST02-3452  
3 Prongs



ST02-3453  
3 Prongs



ST02-3454  
4 Prongs  
Sharp



ST02-3455  
4 Prongs  
Blunt

16 cm / 6 1/4"  
Flexible



ST02-3460  
Fig. 1



ST02-3461  
Fig. 2



ST02-3462  
Fig. 3



ST02-3463  
Fig. 4

16 cm / 6¼"  
Sharp



ST02-3470  
Sharp



ST02-3471  
Blunt

Graefe  
16 cm / 6¼"



O'Connor  
ST02-3480  
16 cm / 6¼"  
Sharp



ST02-3490  
1.5 mm



ST02-3491  
2 mm

Guthrie  
16 cm / 6¼"  
Sharp



Teasing Needle  
ST02-3495  
Straight



Teasing Needle  
ST02-3496  
Angled



**Desmarres**

- ST02-3500 8 mm
  - ST02-3501 10 mm
  - ST02-3502 12 mm
  - ST02-3503 14 mm
  - ST02-3504 16 mm
  - ST02-3505 18 mm
- 16 cm / 6¼"



- ST02-3510 12 mm
  - ST02-3511 14 mm
  - ST02-3512 16 mm
  - ST02-3513 18 mm
- 16 cm / 6¼"



**Mini-Langenbeck**

- ST02-3520 10 x 6 mm
  - ST02-3521 17 x 5 mm
  - ST02-3522 20 x 6 mm
  - ST02-3523 22 x 8 mm
- 16 cm / 6¼"



**Cushing**  
20 cm / 8"

- ST02-3530 8 mm
- ST02-3531 10 mm
- ST02-3532 12 mm
- ST02-3533 14 mm
- ST02-3534 16 mm
- ST02-3535 18 mm

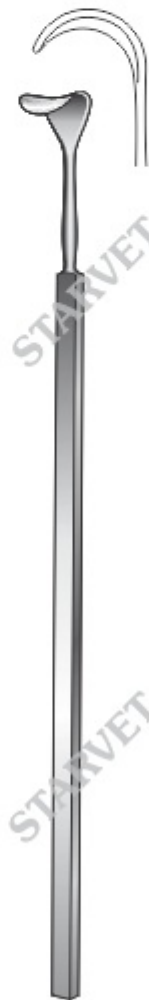

**Cushing**  
24 cm / 9½"

- ST02-3540 8 mm
- ST02-3541 10 mm
- ST02-3542 12 mm
- ST02-3543 14 mm
- ST02-3544 16 mm
- ST02-3545 18 mm



ST02-3550  
16 x 6 mm

Langenbeck-Green  
16 cm / 6¼"



ST02-3551  
24 x 6 mm



ST02-3560  
10 x 6 mm



ST02-3561  
20 x 6 mm



Senn-Green  
15 cm / 6"



8 x 4 mm

15 x 5.5 mm

Ragnell-Davis  
ST02-3570  
14 cm / 5½"



Heavy Sharp Hook  
ST02-3580



Malleable Retractor  
ST02-3590 13 x 175 mm  
ST02-3591 25 x 250 mm  
ST02-3592 50 x 330 mm



Senn-Miller  
16 cm / 6¼"

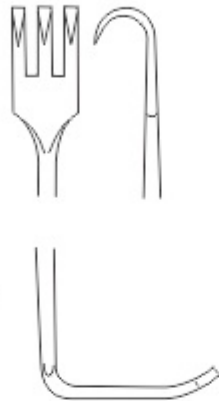

ST02-3600  
7 x 8.5 mm  
3 Prongs  
Sharp

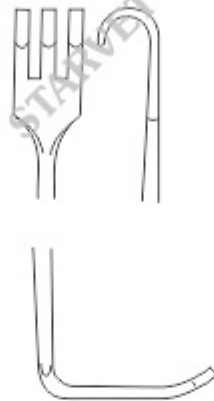

ST02-3601  
7 x 8.5 mm  
3 Prongs  
Blunt

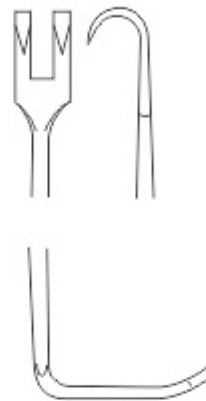

ST02-3602  
7 x 7 mm  
2 Prongs  
Sharp

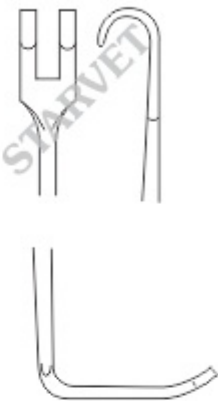

ST02-3603  
7 x 7 mm  
2 Prongs  
Blunt



Fat Pad Retractor  
ST02-3610  
18 cm / 7"



Meyerding  
18 cm / 7"



ST02-3620  
18 x 7 mm  
Fig. 1  
Blunt



ST02-3621  
16 x 5 mm  
Fig. 2  
Toothed



ST02-3622  
7 x 4 mm  
Fig. 3  
Toothed



ST02-3623  
5 x 10 mm  
Fig. 4  
Sharp



ST02-3624  
11 x 4 mm  
Fig. 5  
Blunt



ST02-3625  
6 x 4 mm  
Fig. 6  
Saddle shaped



STARVET



STARVET



STARVET



STARVET



STARVET

Spay Hooks

ST02-3630 13 cm / 5"  
ST02-3631 17 cm / 6 3/4"  
ST02-3632 20 cm / 8"

Spay Hooks

ST02-3640 13 cm / 5"  
ST02-3641 17 cm / 6 3/4"  
ST02-3642 20 cm / 8"

Spay Hooks

ST02-3650 13 cm / 5"  
ST02-3651 17 cm / 6 3/4"  
ST02-3652 20 cm / 8"

Spay Hooks

ST02-3660 13 cm / 5"  
ST02-3661 17 cm / 6 3/4"  
ST02-3662 20 cm / 8"

Spay Hooks

ST02-3670 13 cm / 5"  
ST02-3671 17 cm / 6 3/4"  
ST02-3672 20 cm / 8"



Spay Hooks  
ST02-3680  
13 cm / 5"  
ST02-3681  
17 cm / 6 3/4"  
ST02-3682  
20 cm / 8"

Spay Hooks  
ST02-3690  
13 cm / 5"  
ST02-3691  
17 cm / 6 3/4"  
ST02-3692  
20 cm / 8"

Spay Hooks  
ST02-3700  
13 cm / 5"  
ST02-3701  
17 cm / 6 3/4"  
ST02-3702  
20 cm / 8"

Covault Hooks  
ST02-3710  
17 cm / 6 3/4"  
ST02-3711  
21 cm / 8 1/4"

Covault Hooks  
ST02-3720  
16 cm / 6 1/4"  
ST02-3721  
20 cm / 8"

Covault Hooks  
ST02-3730  
21 cm / 8 1/4"

Covault Hooks  
ST02-3740  
20 cm / 8"  
3 mm jaw

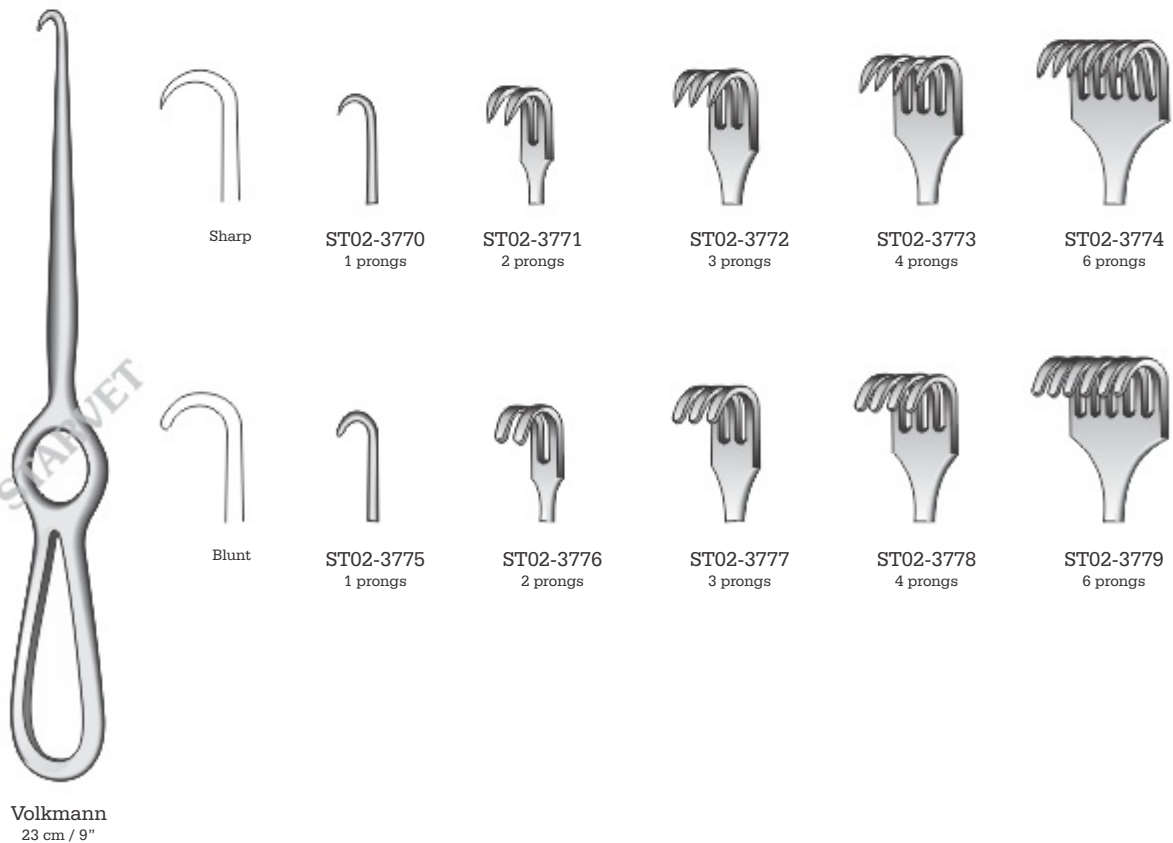
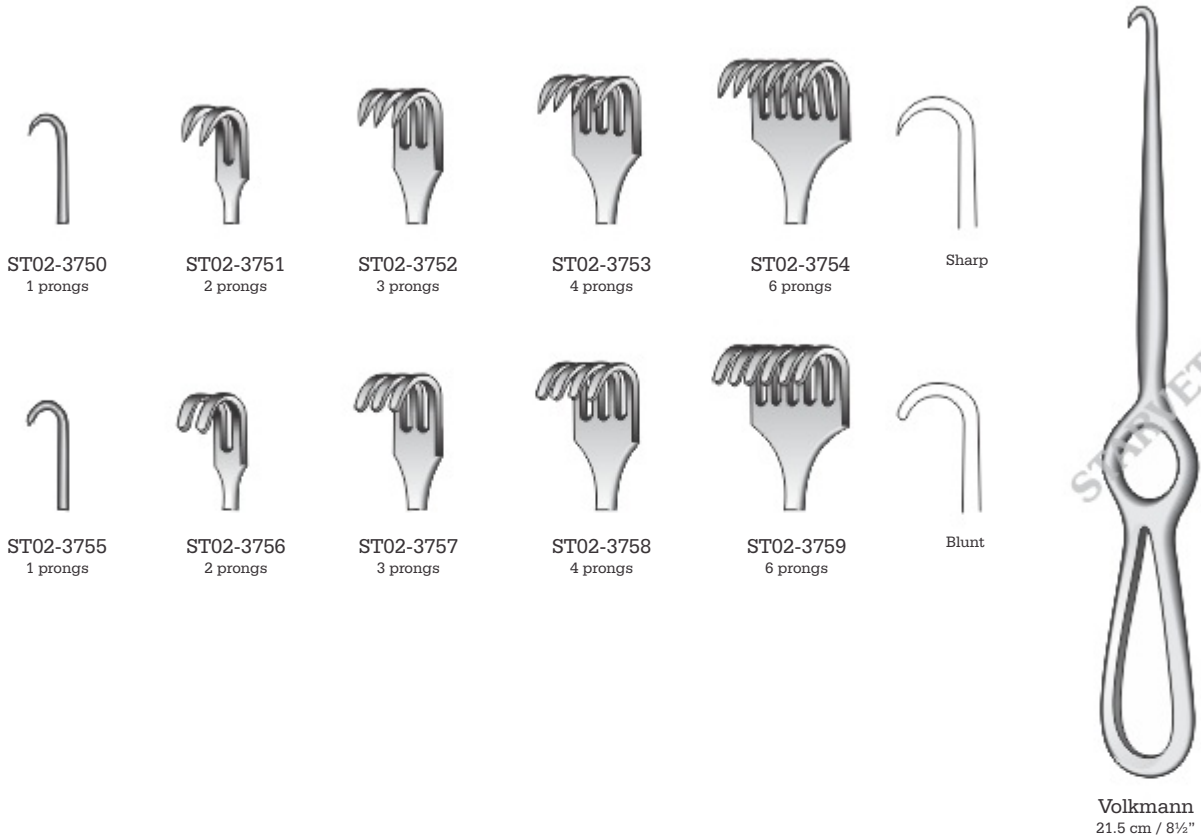





**Murphy**  
19 cm / 7½"  
Sharp



ST02-3790  
2 prongs

ST02-3791  
3 prongs

ST02-3792  
4 prongs

ST02-3793  
6 prongs



**Murphy**  
19 cm / 7½"  
Blunt



ST02-3800  
2 prongs

ST02-3801  
3 prongs

ST02-3802  
4 prongs

ST02-3803  
6 prongs



**Kocher**  
22 cm / 8¾"

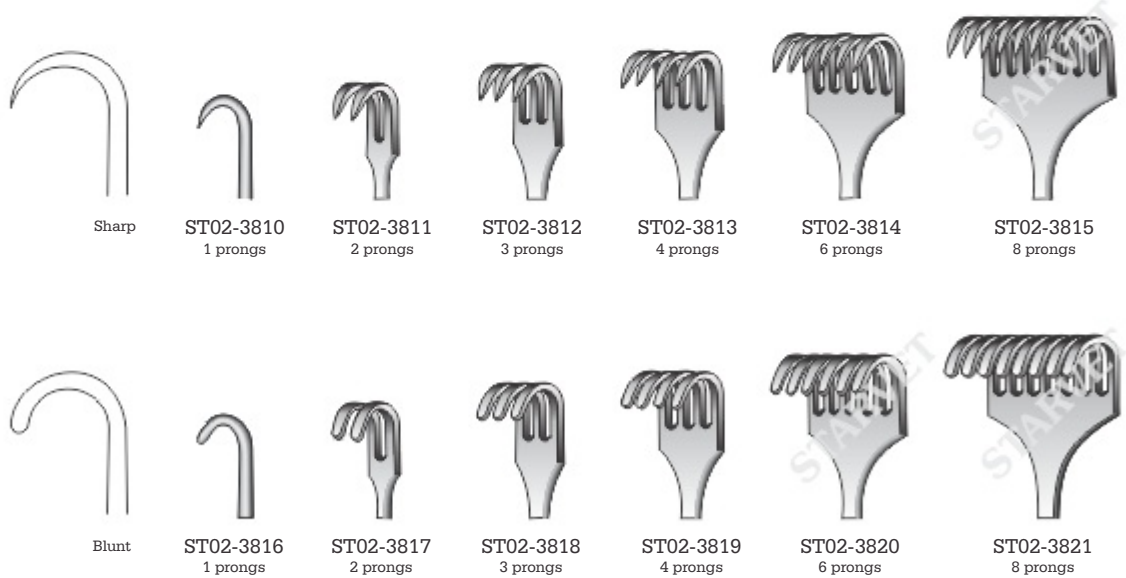

Sharp

ST02-3810  
1 prongs

ST02-3811  
2 prongs

ST02-3812  
3 prongs

ST02-3813  
4 prongs

ST02-3814  
6 prongs

ST02-3815  
8 prongs

Blunt

ST02-3816  
1 prongs

ST02-3817  
2 prongs

ST02-3818  
3 prongs

ST02-3819  
4 prongs

ST02-3820  
6 prongs

ST02-3821  
8 prongs



Langenbeck  
21 cm / 8¼"



ST02-3830  
30 x 11 mm

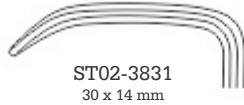

ST02-3831  
30 x 14 mm

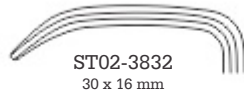

ST02-3832  
30 x 16 mm

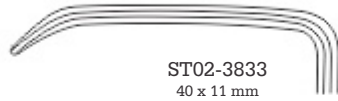

ST02-3833  
40 x 11 mm



ST02-3834  
50 x 11 mm



Langenbeck  
22 cm / 8½"



ST02-3840  
30 x 11 mm

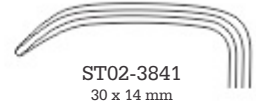

ST02-3841  
30 x 14 mm



ST02-3842  
30 x 16 mm

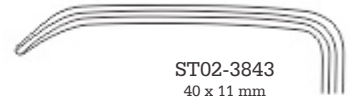

ST02-3843  
40 x 11 mm



ST02-3844  
50 x 11 mm



Langenbeck  
ST02-3850 6 mm  
ST02-3851 6 mm x 35 mm  
ST02-3852 13 mm  
ST02-3853 20 mm  
ST02-3854 25 mm  
21.5 cm / 8½"



Morris  
ST02-3860 21.5 cm / 8¼"  
Blade 3.8 cm / 1½"  
ST02-3861 26 cm / 10¼"  
Blade 5 cm / 2"  
ST02-3862 22 cm / 8½"  
Blade 6.5 cm / 2½"



Deaver  
ST02-3870  
18 cm / 7"  
19 mm

Deaver  
ST02-3871  
21.5 cm / 8½"  
22 mm

Deaver  
ST02-3872  
23 cm / 9"  
25 mm

Deaver  
ST02-3873  
30 cm / 12"  
25 mm

Deaver  
ST02-3874  
33 cm / 13"  
25 mm

Deaver  
ST02-3875  
36 cm / 14"  
25 mm



Deaver  
ST02-3880  
30 cm / 12"  
38 mm



Deaver  
ST02-3881  
30 cm / 12"  
50 mm



Deaver  
ST02-3882  
30 cm / 12"  
75 mm



Meyerding  
ST02-3890  
25.5 cm / 10"  
89 x 50 mm  
For deep surgery

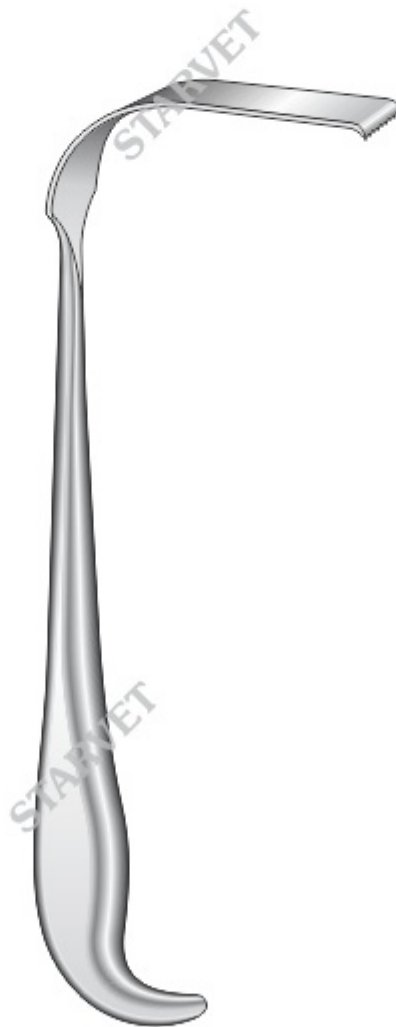

ST02-3891  
23 cm / 9"  
76 x 25 mm



ST02-3892  
21 cm / 8¼"  
52 x 16 mm

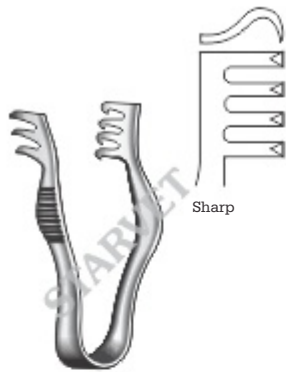

Finsen  
ST02-3900 Sharp  
ST02-3901 Blunt  
7 cm / 2¾"

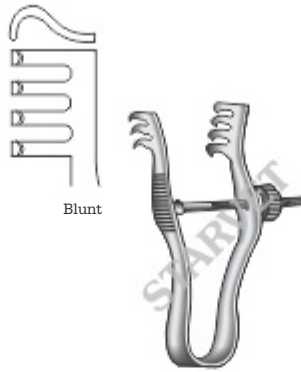

Finsen  
ST02-3910 Sharp  
ST02-3911 Blunt  
7 cm / 2¾"  
With adjusting screw

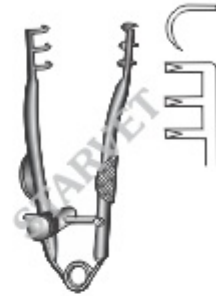

Buckley  
ST02-3920  
6 cm / 2½"

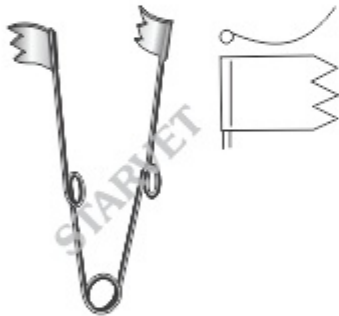

ST02-3930  
8 cm / 3¼"



Alm

ST02-3940 7 cm / 2¾"  
ST02-3942 10 cm / 4"  
Sharp Blunt

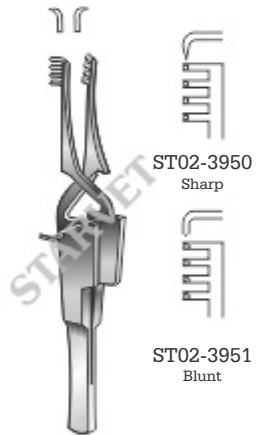

ST02-3950  
Sharp

ST02-3951  
Blunt

10 cm / 4"

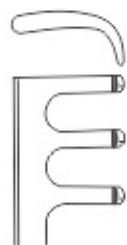

ST02-3960  
Blunt



Jansen  
10 cm / 4"



ST02-3961  
Sharp

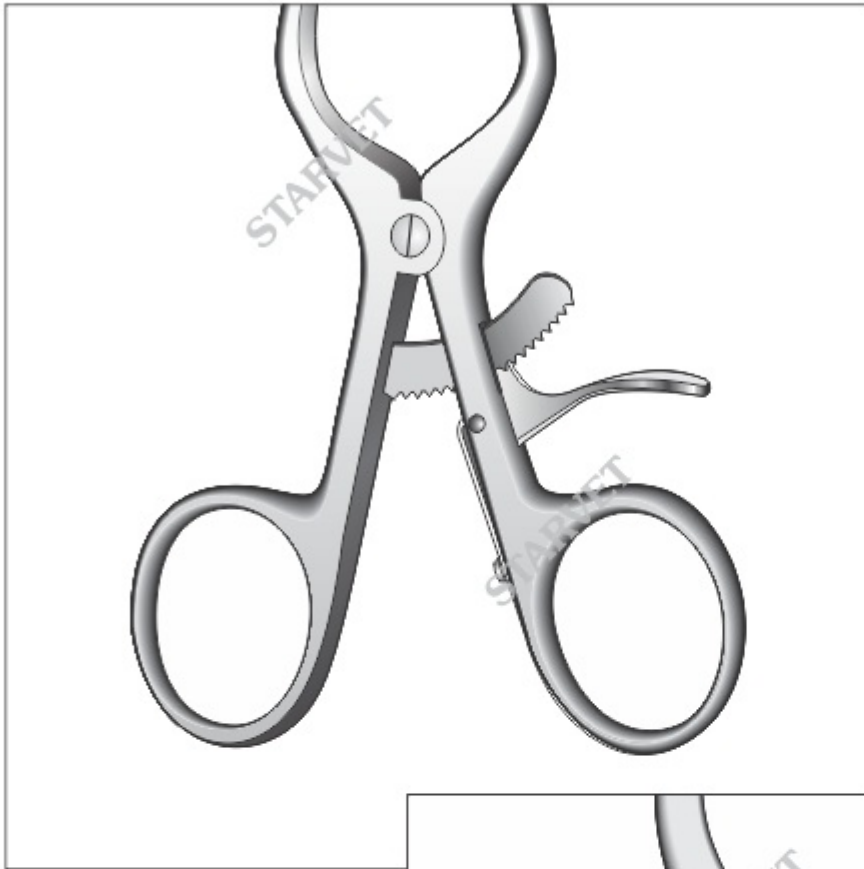

These self retaining mechanisms are available for the similar kind of retractors.

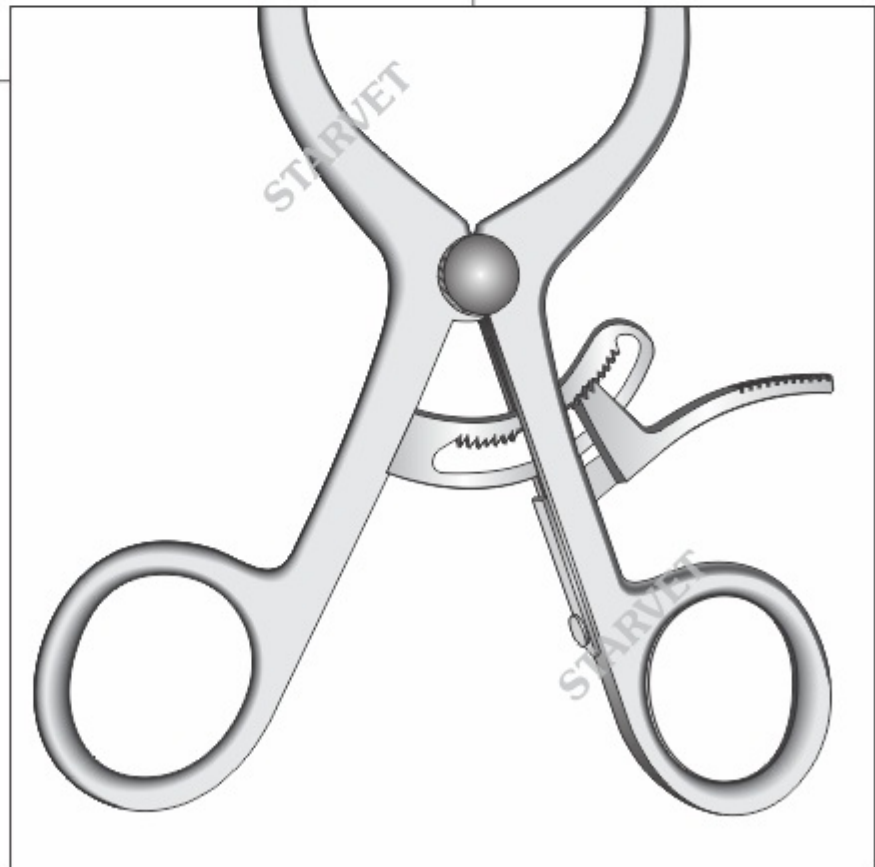

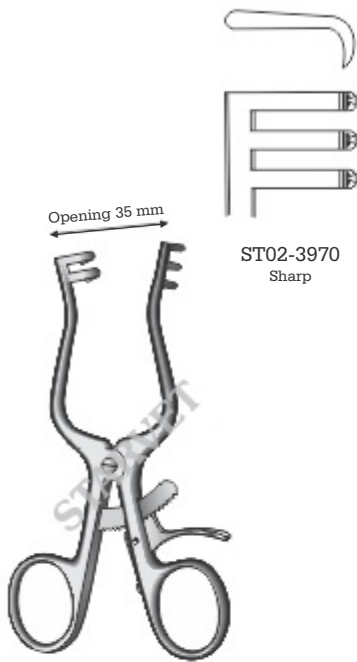

ST02-3970  
Sharp

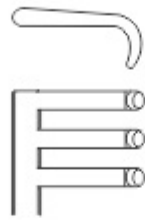

ST02-3971  
Blunt



ST02-3980  
ST02-3982  
ST02-3984  
ST02-3986  
ST02-3988  
ST02-3990  
Sharp



ST02-3981  
ST02-3983  
ST02-3985  
ST02-3987  
ST02-3989  
ST02-3991  
Blunt



Weitlaner  
3:4 Teeth



West  
ST02-4000 13 cm / 5¼"  
ST02-4001 9.5 cm / 3¾"  
3:4 Teeth  
Curved



Norfolk-Norwich  
ST02-4010  
22 cm / 8¾"  
Blunt



Travers  
ST02-4020 20 cm / 8"  
ST02-4021 9.5 cm / 3¾"  
ST02-4022 16.5 cm / 6½"





Mayo-Adams  
ST02-4030  
17 cm / 6¾"

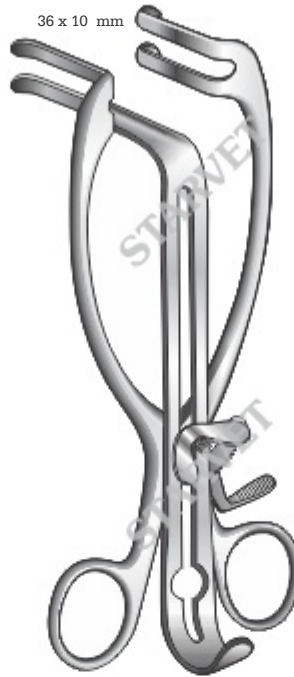

Mayo-Adams  
ST02-4040  
17 cm / 6¾"  
With center blade



Adson-Baby / Cone  
ST02-4050 13 cm / 5¼" ST02-4051  
ST02-4052 16 cm / 6¼" ST02-4053  
Sharp Blunt



Long Reach Gelpi

ST02-4080	30 mm	ST02-4081
ST02-4082	40 mm	ST02-4083
ST02-4084	50 mm	ST02-4085
ST02-4086	60 mm	ST02-4087
ST02-4088	70 mm	ST02-4089
Sharp	14 cm / 5½"	Blunt
ST02-4100	30 mm	ST02-4101
ST02-4102	40 mm	ST02-4103
ST02-4104	50 mm	ST02-4105
ST02-4106	60 mm	ST02-4107
ST02-4108	70 mm	ST02-4109
Sharp	16 cm / 6¼"	Blunt
ST02-4120	30 mm	ST02-4121
ST02-4122	40 mm	ST02-4123
ST02-4124	50 mm	ST02-4125
ST02-4126	60 mm	ST02-4127
ST02-4128	70 mm	ST02-4129
Sharp	18 cm / 7"	Blunt
ST02-4140	30 mm	ST02-4141
ST02-4142	40 mm	ST02-4143
ST02-4144	50 mm	ST02-4145
ST02-4146	60 mm	ST02-4147
ST02-4148	70 mm	ST02-4149
Sharp	20 cm / 8"	Blunt



Long Reach Gelpi

ST02-4180	30 mm	ST02-4181
ST02-4182	40 mm	ST02-4183
ST02-4184	50 mm	ST02-4185
ST02-4186	60 mm	ST02-4187
ST02-4188	70 mm	ST02-4189
Sharp	14 cm / 5½"	Blunt
ST02-4200	30 mm	ST02-4201
ST02-4202	40 mm	ST02-4203
ST02-4204	50 mm	ST02-4205
ST02-4206	60 mm	ST02-4207
ST02-4208	70 mm	ST02-4209
Sharp	16 cm / 6¼"	Blunt
ST02-4220	30 mm	ST02-4221
ST02-4222	40 mm	ST02-4223
ST02-4224	50 mm	ST02-4225
ST02-4226	60 mm	ST02-4227
ST02-4228	70 mm	ST02-4229
Sharp	18 cm / 7"	Blunt
ST02-4240	30 mm	ST02-4241
ST02-4242	40 mm	ST02-4243
ST02-4244	50 mm	ST02-4245
ST02-4246	60 mm	ST02-4247
ST02-4248	70 mm	ST02-4249
Sharp	20 cm / 8"	Blunt

Gelpi

ST02-4060	9 cm / 3½"	ST02-4061
ST02-4062	11.5 cm / 4½"	ST02-4063
ST02-4064	14 cm / 5½"	ST02-4065
ST02-4066	16 cm / 6¼"	ST02-4067
ST02-4068	18 cm / 7"	ST02-4069
ST02-4070	20 cm / 8"	ST02-4071
Sharp		Blunt

Gelpi

ST02-4160	9 cm / 3½"	ST02-4161
ST02-4162	11.5 cm / 4½"	ST02-4163
ST02-4164	14 cm / 5½"	ST02-4165
ST02-4166	16 cm / 6¼"	ST02-4167
ST02-4168	18 cm / 7"	ST02-4169
ST02-4170	20 cm / 8"	ST02-4171
Sharp		Blunt



**Spikel Shield**  
ST02-4260 12.5 cm / 5"  
ST02-4261 18 cm / 7"  
Left

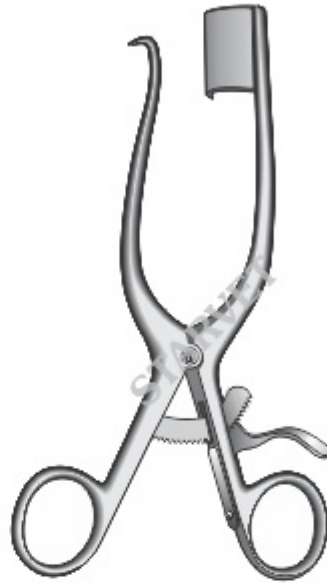

**Spikel Shield**  
ST02-4265 12.5 cm / 5"  
ST02-4266 18 cm / 7"  
Right

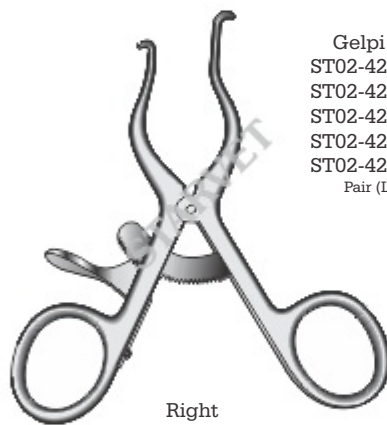

**Gelpi (Odd Leg)**  
ST02-4270 10 cm / 4"  
ST02-4271 12 cm / 4¾"  
ST02-4272 13.5 cm / 5¼"  
ST02-4273 16 cm / 6¼"  
ST02-4274 20 cm / 8"  
Pair (Left + Right)

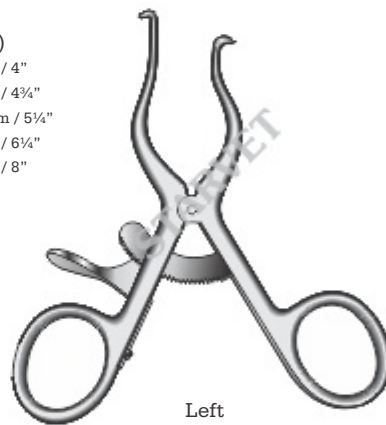

Right

Left

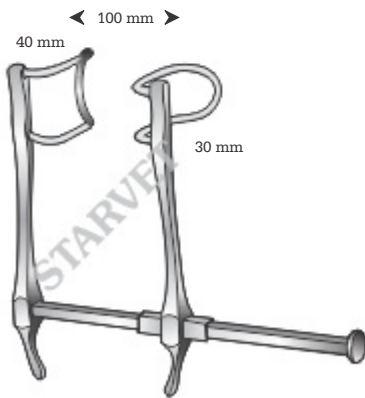

**Gosset-Baby**  
ST02-4280 100 mm Spread, Small  
ST02-4281 130 mm Spread, Large

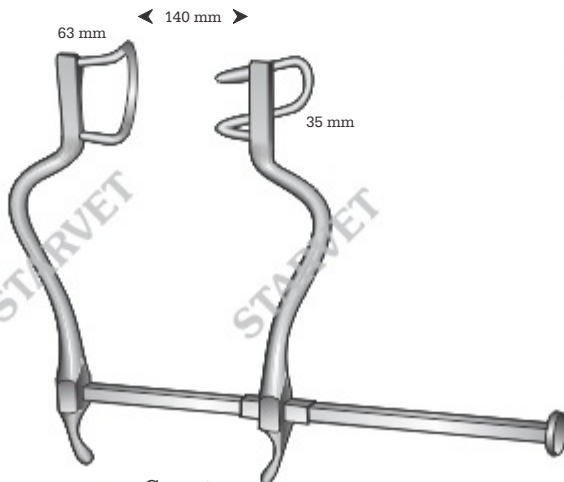

**Gosset**  
ST02-4290

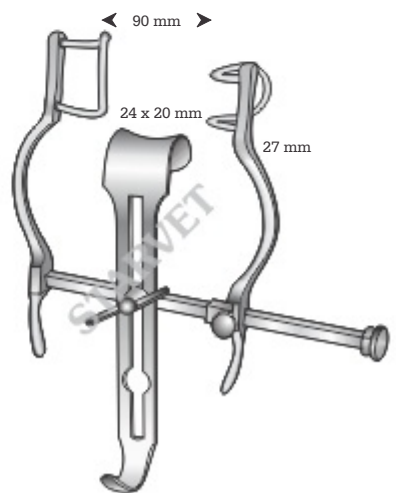

**Balfour-Baby**  
ST02-4300 Single Bar  
ST02-4301 Double bar

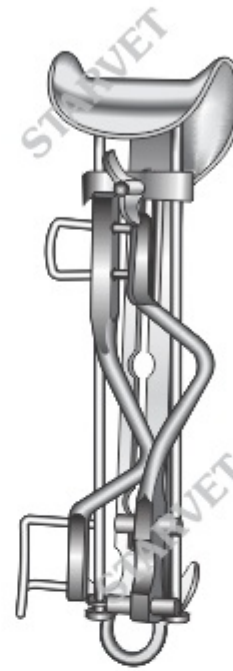
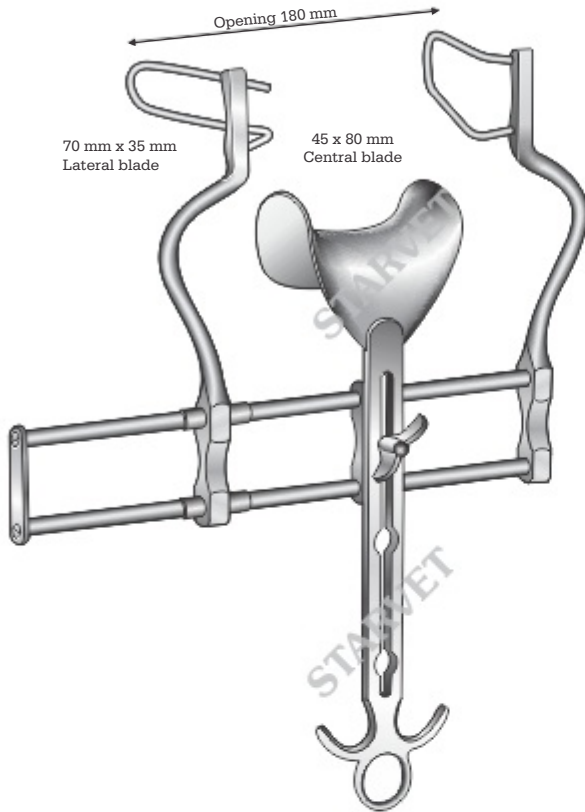

Balfour  
ST02-4330  
Locking Ring

Balfour  
ST02-4320 180 mm  
Detachable

**Balfour**

ST02-4310	115 mm opening
ST02-4311	135 mm opening
ST02-4312	155 mm opening
ST02-4313	180 mm opening
ST02-4314	200 mm opening



**Balfour**  
ST02-4340 45 x 80 mm  
ST02-4341 70 x 85 mm

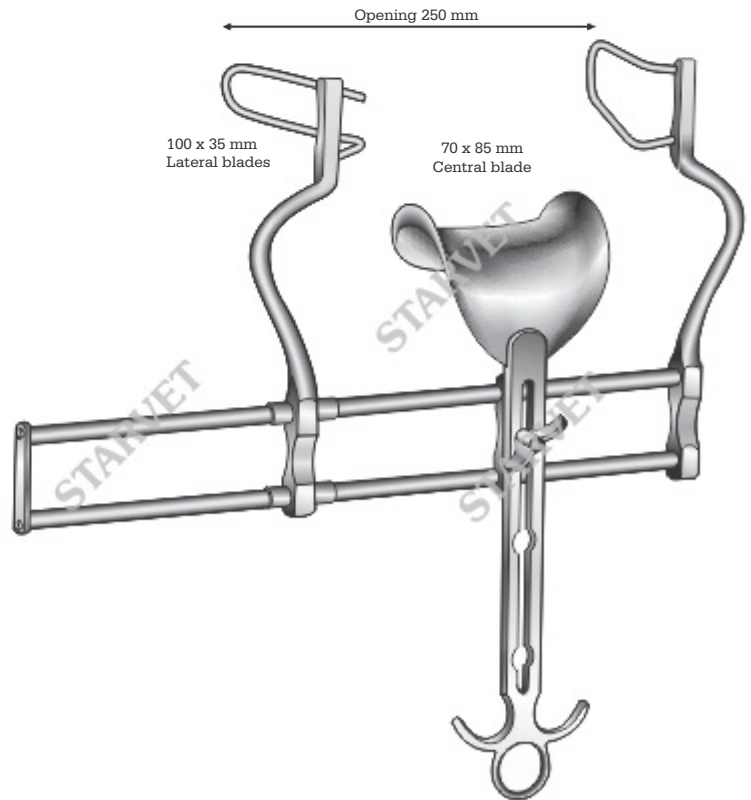

**Balfour**  
ST02-4350

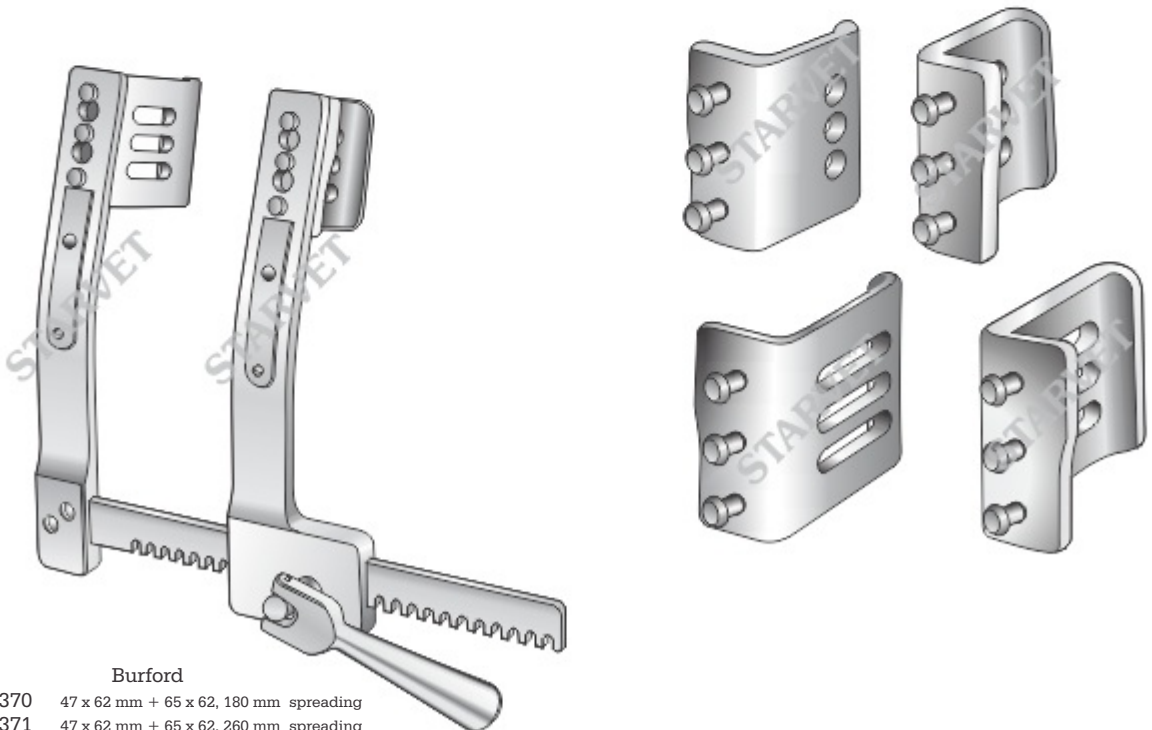
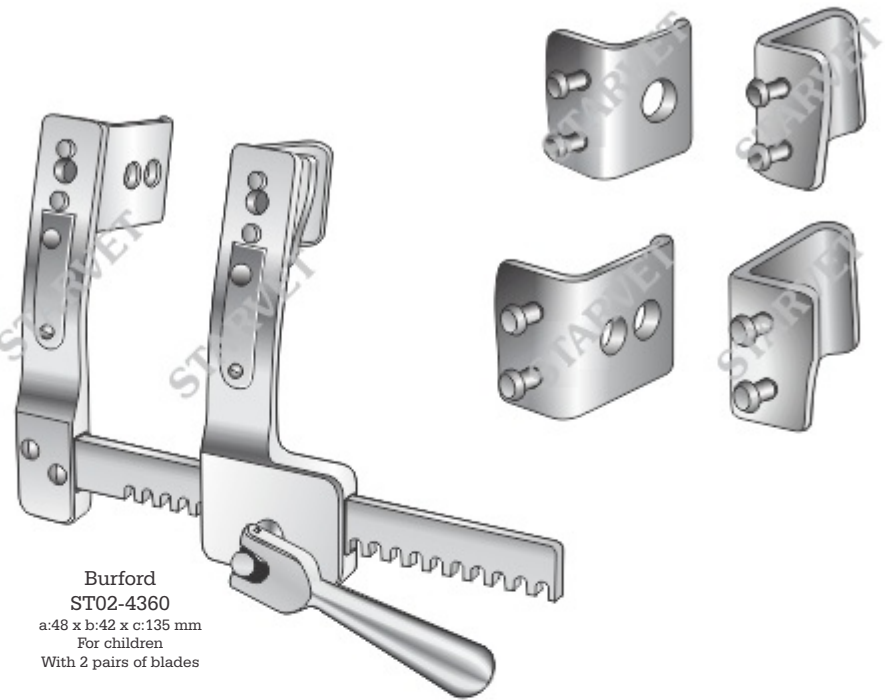
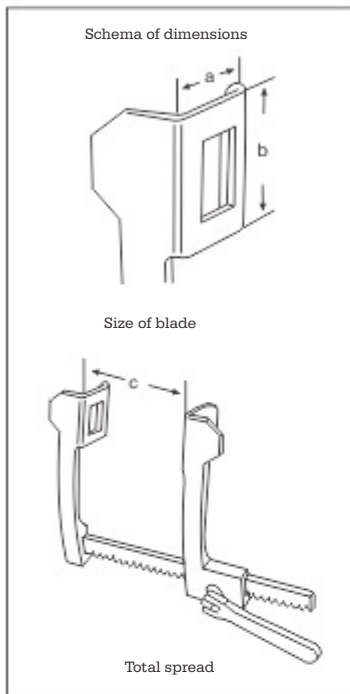

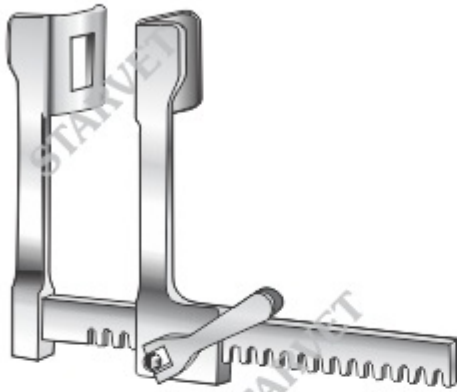

**Finochietto-Baby**

ST02-4380	75 mm
ST02-4381	95 mm
ST02-4382	130 mm
ST02-4383	165 mm
ST02-4384	180 mm
ST02-4385	200 mm
ST02-4386	250 mm

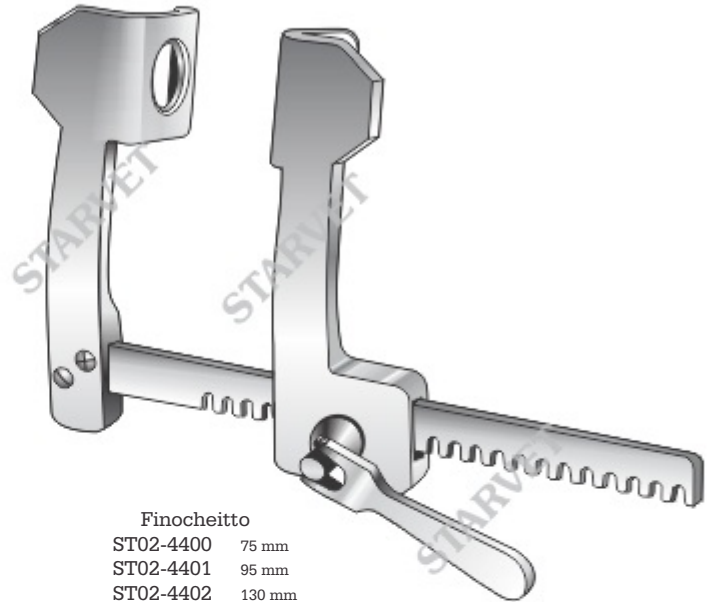

**Finochietto**

ST02-4400	75 mm
ST02-4401	95 mm
ST02-4402	130 mm
ST02-4403	165 mm
ST02-4404	180 mm
ST02-4405	200 mm
ST02-4406	250 mm

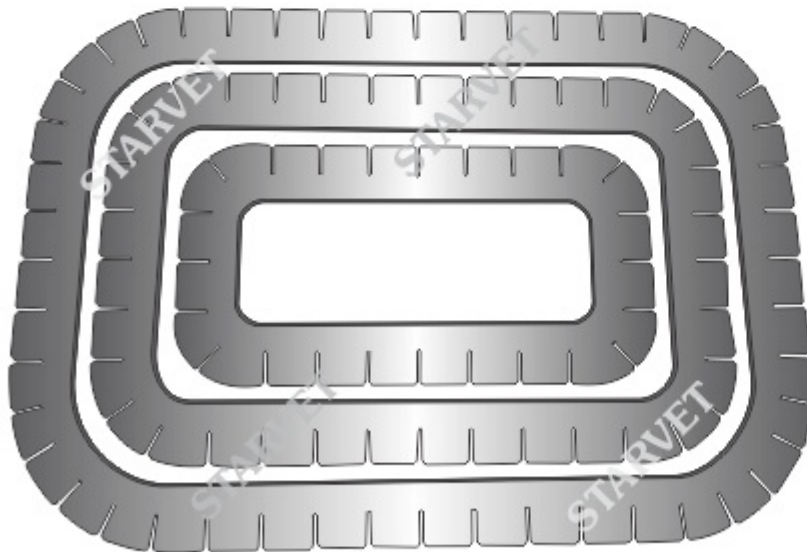

**Ring Retractors**

ST02-4420	110 x 40 mm, Small
ST02-4421	160 x 85 mm, Medium
ST02-4422	200 x 130 mm, Large
ST02-4423	220 x 250 mm, Extra Large
ST02-4424	Set Of 3, With 10 Silicon Hooks



**Silicon Hooks**  
ST02-4426  
Pack of 10

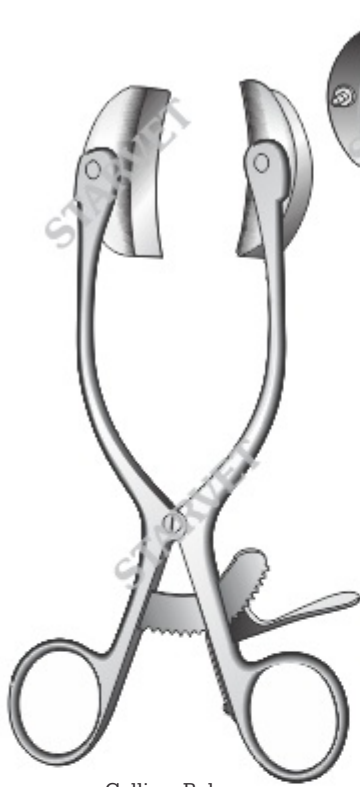

**Collins, Baby**  
ST02-4430  
20 cm / 8"  
Spread 110 mm  
Complete with 2 pairs of lateral blades  
(18 x 40 mm), (27 x 40 mm)



**Collins**  
ST02-4440  
20 cm / 8"  
110 mm Opening



**Collins**  
ST02-4450 With center blade  
ST02-4451 Without center blade  
25 cm / 10"  
ST02-4452 With center blade  
ST02-4453 Without center blade  
28 cm / 11"  
Spread 110 mm



**Caspar**  
ST02-4460 Retractor With Standard Blades (6) 170 mm  
ST02-4461 Caspar Cervical Distractor Pins (2)  
ST02-4462 Set Extended Length Blades 8, 10, 12 & 15 cm

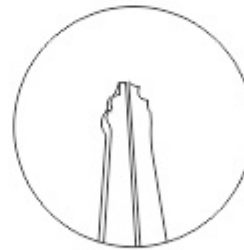

ST02-4470  
Small Spine Distractor



Wallace Distracter  
ST02-4480



Wallace Distracter  
ST02-4490



Wallace Distracter  
ST02-4500 Jaw Overlapping, 3 mm  
ST02-4501 Jaw Overlapping, 6 mm



Stifle Distracter  
ST02-4510



Large Distracter  
ST02-4520



Stifle Distracter  
ST02-4530 10 cm / 4"  
ST02-4531 13 cm / 5"  
Jaw over lapping 3 mm



Stifle Distracter  
ST02-4540  
13 cm / 5"  
Jaw over lapping 6 mm



Stifle Distracter  
ST02-4550 12 cm / 4 3/4"  
Jaw overlapping 3 mm  
ST02-4551 14 cm / 5 1/2"  
Jaw overlapping 6 mm  
ST02-4552 19 cm / 7 1/2"  
Jaw over lapping 8 mm  
ST02-4553 21 cm / 8 1/4"  
Jaw over lapping 10 mm



Stifle Distracter  
ST02-4560 12 cm / 4 3/4"  
Jaw over lapping 3 mm  
ST02-4561 14 cm / 5 1/2"  
Jaw over lapping 6 mm  
ST02-4562 19 cm / 7 1/2"  
Jaw over lapping 8 mm  
ST02-4563 21 cm / 8 1/4"  
Jaw over lapping 10 mm



Stifle Distracter  
ST02-4570 12 cm / 4 3/4"  
Jaw over lapping 3 mm  
ST02-4571 14 cm / 5 1/2"  
Jaw over lapping 6 mm  
ST02-4572 19 cm / 7 1/2"  
Jaw over lapping 8 mm  
ST02-4573 21 cm / 8 1/4"  
Jaw over lapping 10 mm



Stifle Distracter  
With Ratchet  
ST02-4580 19 cm / 7 1/2"  
Jaw over lapping 8 mm  
ST02-4581 21 cm / 8 1/4"  
Jaw over lapping 10 mm





Round Handle  
ST02-4590  
2 mm Probe  
22 cm / 8½"



Mall Probe  
ST02-4595



Square Handle  
ST02-4600  
1 mm Probe  
22 cm / 8½"



Butterfly  
ST02-4610 11.5 cm / 4¾"  
ST02-4612 12.5 cm / 5"  
ST02-4614 14 cm / 5½"  
ST02-4616 16.5 cm / 6½"  
ST02-4618 18 cm / 7"  
ST02-4620 20.5 cm / 8"



ST02-4611  
ST02-4613  
ST02-4615  
ST02-4617  
ST02-4619  
ST02-4621



Doyen  
ST02-4630  
14 cm / 5½"



Nelaton  
ST02-4640  
16 cm / 6¼"



Derf  
ST02-4650  
12 cm / 4¾"



Derf  
ST02-4660  
12.5 cm / 5"

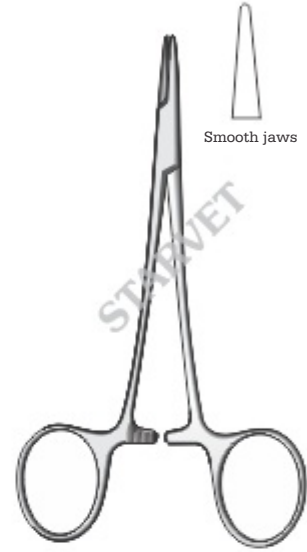

Halsey  
ST02-4670 Standard  
ST02-4671 Delicate  
12.5 cm / 5"

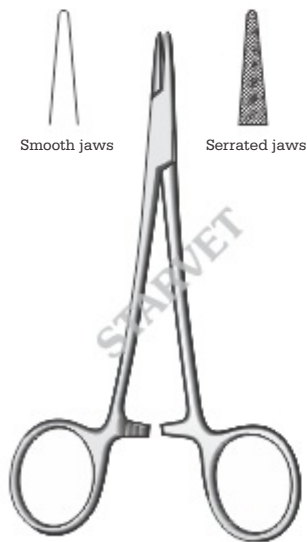

Smooth jaws

Serrated jaws

Webster  
ST02-4680 Smooth  
ST02-4681 Serrated  
13 cm / 5", Delicate



Neivert  
ST02-4690  
13 cm / 5"



Kilner  
ST02-4700  
13.5 cm / 5¼"



Hegar-Baumgartner  
ST02-4710  
14 cm / 5½"



Crile-Murray  
ST02-4720  
15 cm / 6"



Crile-Wood  
ST02-4730 15 cm / 6"  
ST02-4731 18 cm / 7"  
ST02-4732 20 cm / 8"



Mayo-Hegar



ST02-4740  
14 cm / 5½"



ST02-4741  
16 cm / 6¼"



ST02-4742  
18 cm / 7"



ST02-4743  
20 cm / 8"

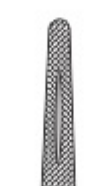

ST02-4744  
24 cm / 9½"



ST02-4745  
26 cm / 10¼"



Bruce-Clarke  
ST02-4750  
12.5 cm / 5"

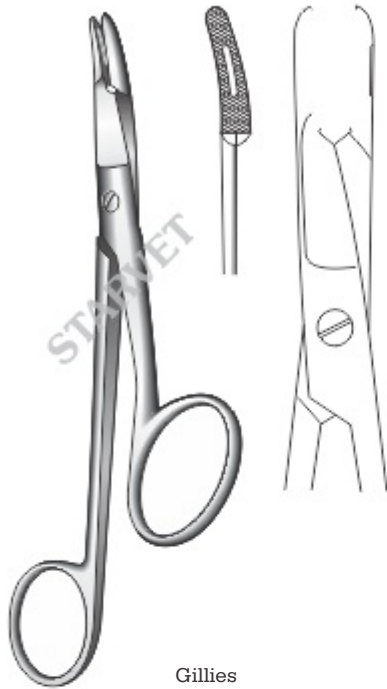

**Gillies**  
ST02-4760 Right hand  
ST02-4761 Left hand  
16 cm / 6¼"  
Serrated jaws



**Forester Gillies**  
ST02-4770 Right hand  
ST02-4771 Left hand  
12.5 cm / 5"  
Serrated jaws



**Mini Gillies**  
ST02-4780 Left hand  
ST02-4781 Right hand  
10 cm / 4"



**Olsen-Hegar**  
ST02-4790 14 cm / 5½"  
ST02-4791 16 cm / 6¼"  
ST02-4792 17 cm / 6¾"  
ST02-4793 19 cm / 7½"



**Olsen-Hegar**  
ST02-4800 12 cm / 4¾" Mini  
ST02-4801 14 cm / 5½"  
ST02-4802 16 cm / 6¼"  
ST02-4803 18 cm / 7"  
ST02-4804 19 cm / 7½"



ST02-4810 14 cm / 5½" ST02-4811  
ST02-4812 16 cm / 6¼" ST02-4813  
ST02-4814 17 cm / 6¾" ST02-4815  
ST02-4816 18 cm / 7" ST02-4817  
ST02-4818 19 cm / 7½" ST02-4819  
Standard Super Cut



**Mathieu-Olsen**  
ST02-4830 14 cm / 5½"  
ST02-4831 17 cm / 6¾"  
ST02-4832 19 cm / 7½"



ST02-4840	14 cm / 5½"	ST02-4841
ST02-4842	16 cm / 6¼"	ST02-4843
ST02-4844	17 cm / 6¾"	ST02-4845
ST02-4846	20 cm / 8"	ST02-4847
ST02-4848	24 cm / 9½"	ST02-4849



**Mathieu**



**MacPhail**  
(Cooper jaw)  
ST02-4860 14 cm / 5½"  
ST02-4861 16 cm / 6¼"  
ST02-4862 18 cm / 7"  
ST02-4863 20 cm / 8"

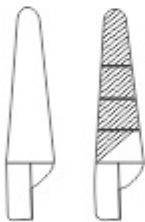

**Mathieu**  
Slender jaws



ST02-4870  
14 cm / 5½"



ST02-4871  
17 cm / 6¾"



**Mathieu**



ST02-4880  
17 cm / 6¾"



ST02-4881  
20 cm / 8"

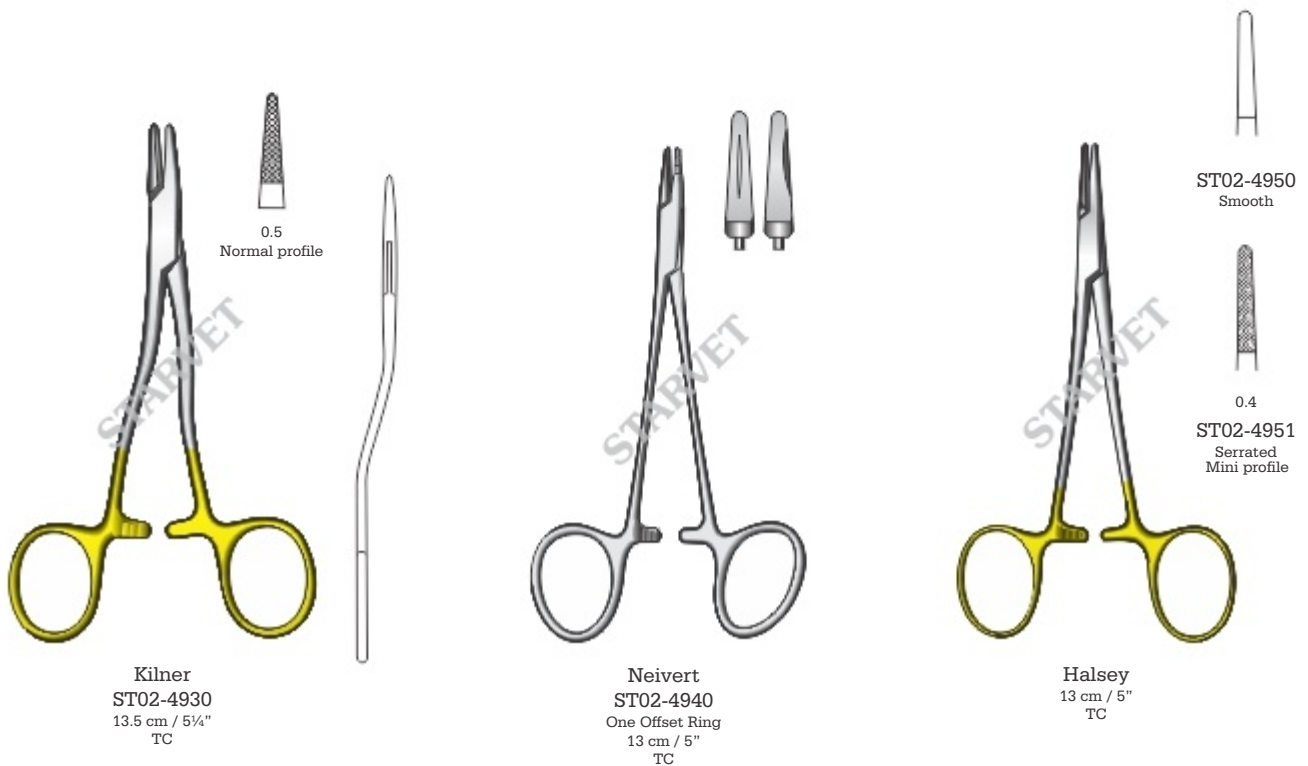



With automatic release ratchet  
**ST02-4960** For right hand  
**ST02-4961** For left hand  
 13 cm / 5"  
**ST02-4962** For right hand  
**ST02-4963** For left hand  
 15 cm / 6"  
 TC



Mayo-Hegar  
TC

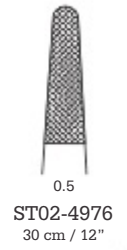
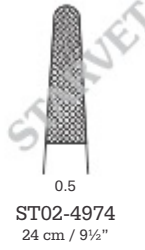
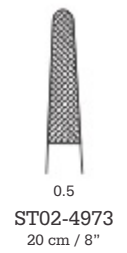
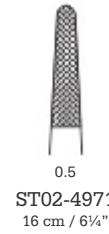
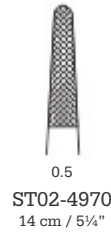

Neivert  
**ST02-4990**  
13 cm / 5"  
Angled Rings  
TC



Crile-Wood  
TC



**ST02-5000** 15 cm / 6"  
**ST02-5001** 18 cm / 7"  
**ST02-5002** 20 cm / 8"  
**ST02-5003** 23 cm / 9"  
**ST02-5004** 25 cm / 10"  
**ST02-5005** 30 cm / 12"  
 Mini profile

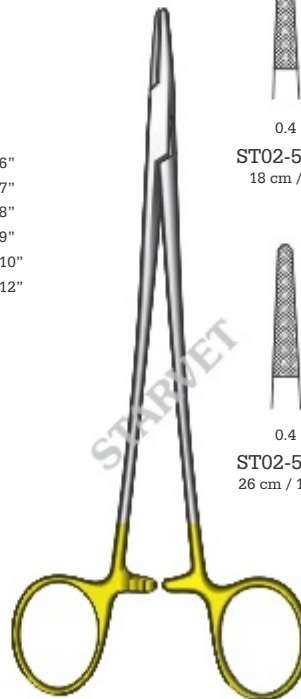

De Bakey  
TC

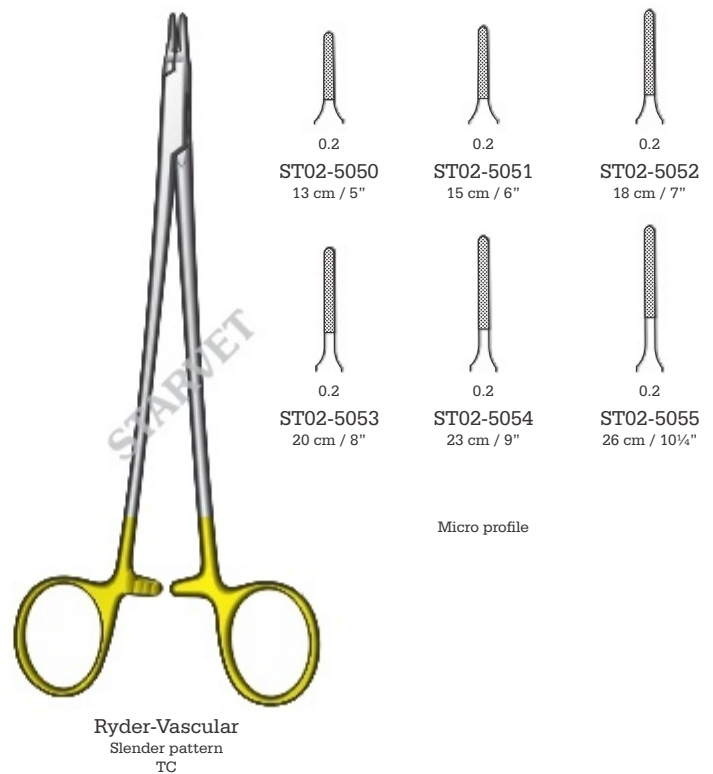
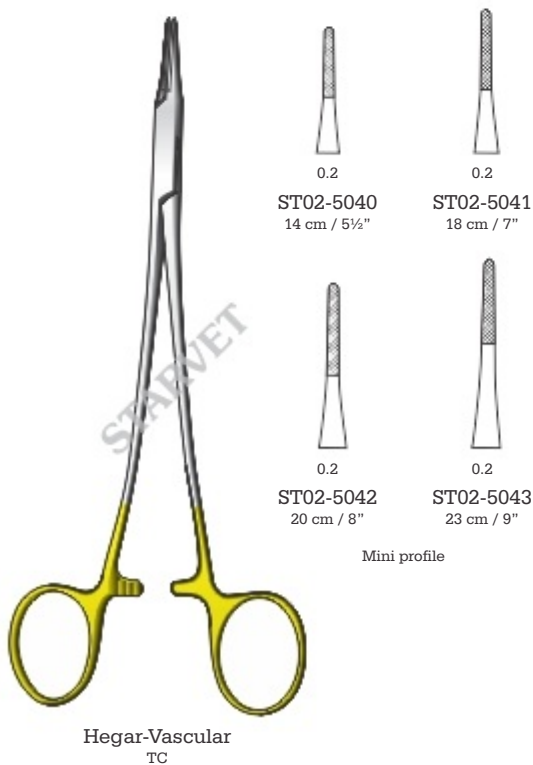
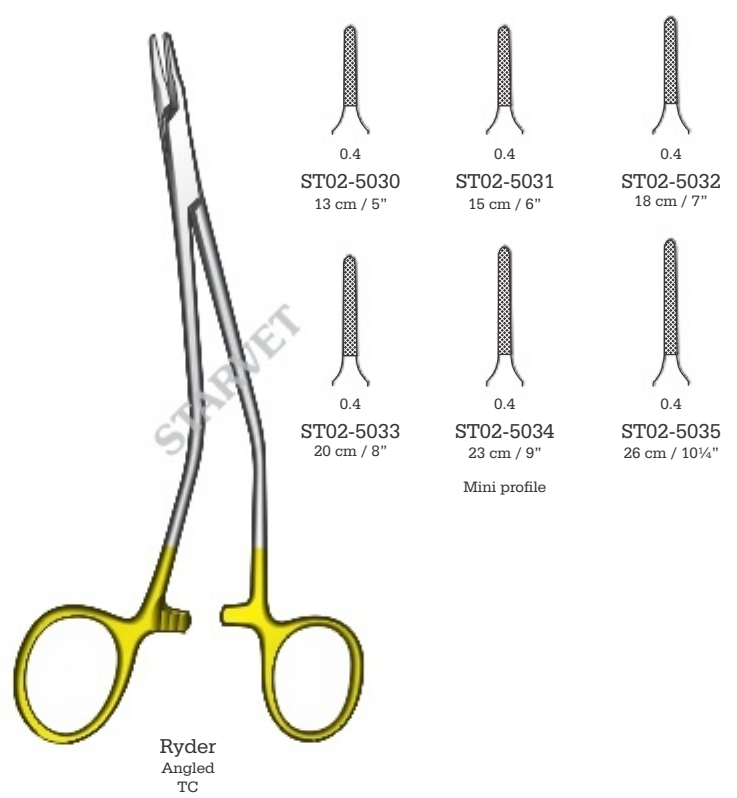
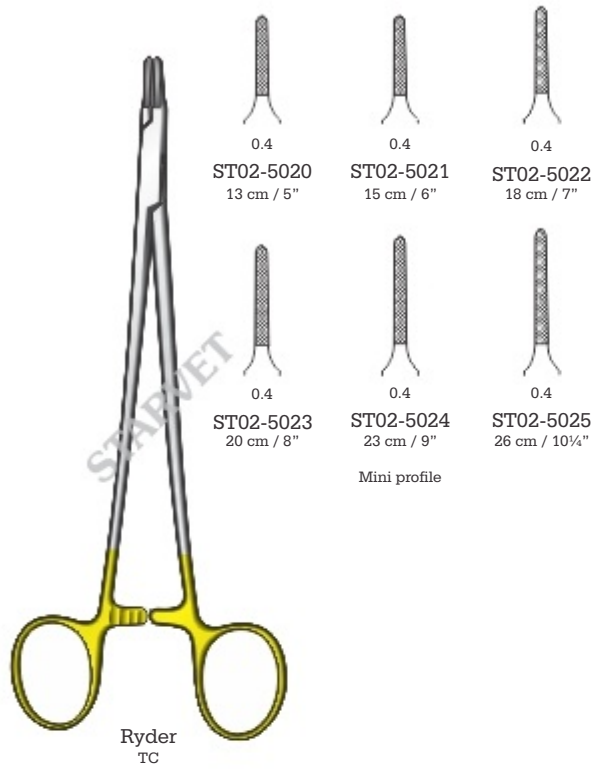





Olsen-Hegar  
ST02-5060 14 cm / 5½"  
ST02-5061 16 cm / 6¼"  
ST02-5062 17 cm / 6¾"  
ST02-5063 19 cm / 7½"  
TC

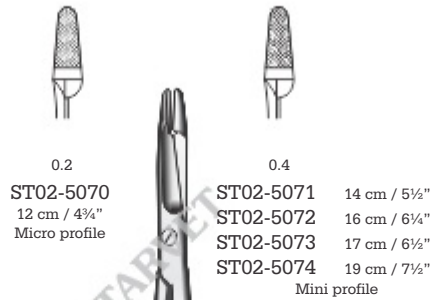

Olsen-Hegar  
TC



Olsen-Hegar  
ST02-5080 ST02-5081 ST02-5082 14 cm / 5½"  
ST02-5083 ST02-5084 ST02-5085 16 cm / 6¼"  
ST02-5086 ST02-5087 ST02-5088 17 cm / 6¾"  
ST02-5089 ST02-5090 ST02-5091 18 cm / 7"  
ST02-5092 ST02-5093 ST02-5094 19 cm / 7½"  
Standard TC TC/SC



Forester Gillies  
ST02-5100 Right hand  
ST02-5101 Left hand  
12.5 cm / 5"  
TC, Serrated Jaws



Gillies  
ST02-5110 Right hand  
ST02-5111 Left hand  
16 cm / 6¼"  
TC, Mini profile

Mini Gillies  
Special model  
ST02-5112 Right hand  
ST02-5113 Left hand  
12 cm / 4¾"  
TC, Mini profile

ST02-5114  
10 cm / 4"  
TC, Micro profile



Insemination Scissors  
ST02-5120  
16 cm / 6¼"



Mathieu-Olsen  
ST02-5123 14 cm / 5½"  
ST02-5124 17 cm / 6¾"  
ST02-5125 19 cm / 7½"  
TC



Staple Remover  
ST02-5128  
14 cm / 5½"



Mathieu  
TC

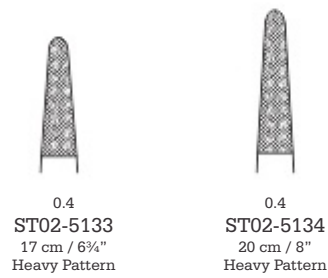
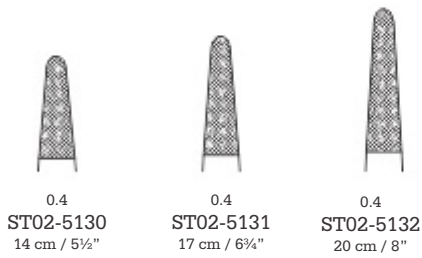

Mini profile



Mathieu - Standard  
TC

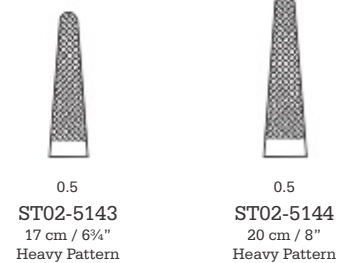
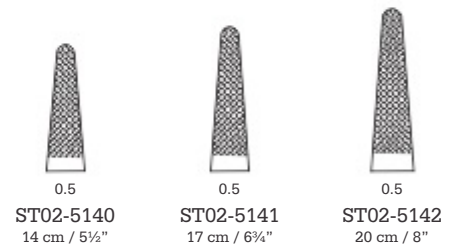

Normal profile

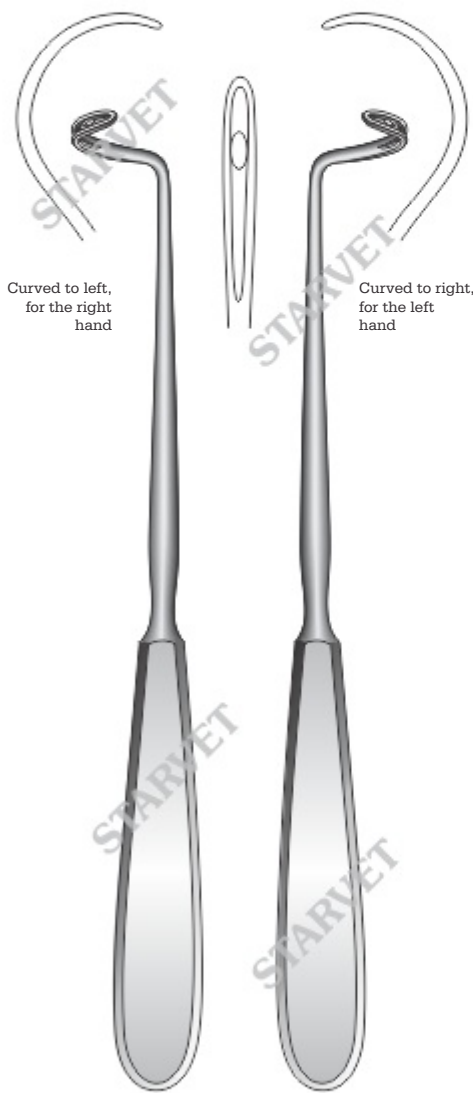

Deschamps  
ST02-5150 Curved to left  
ST02-5151 Curved to right  
21 cm / 8 1/4"  
Blunt



Deschamps  
ST02-5160 Curved to left  
ST02-5161 Curved to right  
21 cm / 8 1/4"  
Sharp



Beeson  
ST03-0001  
30 cm / 12"



Smith  
ST03-0010  
23.5 cm / 9½"



Hennig  
ST03-0020  
28 cm / 11"

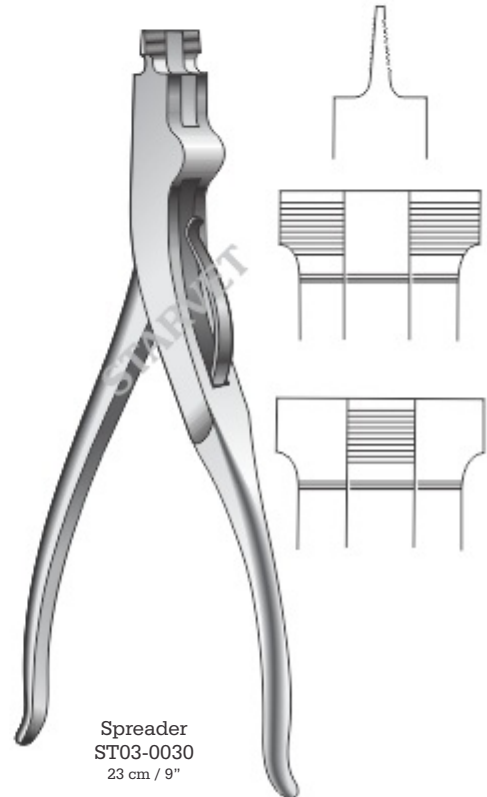

Spreader  
ST03-0030  
23 cm / 9"

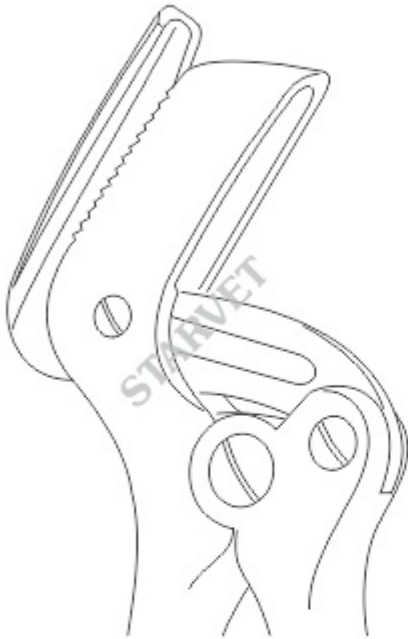

ST03-0040  
Blade with reinforced back  
ST03-0041  
Blade without reinforced back  
23 cm / 9"

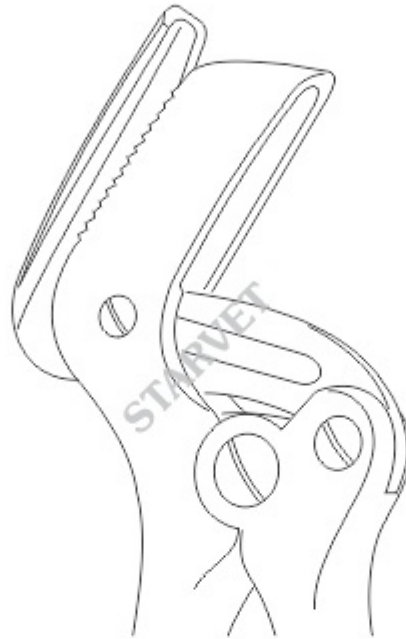

ST03-0042  
Blade with reinforced back  
ST03-0043  
Blade without reinforced back  
26 cm / 10¼"

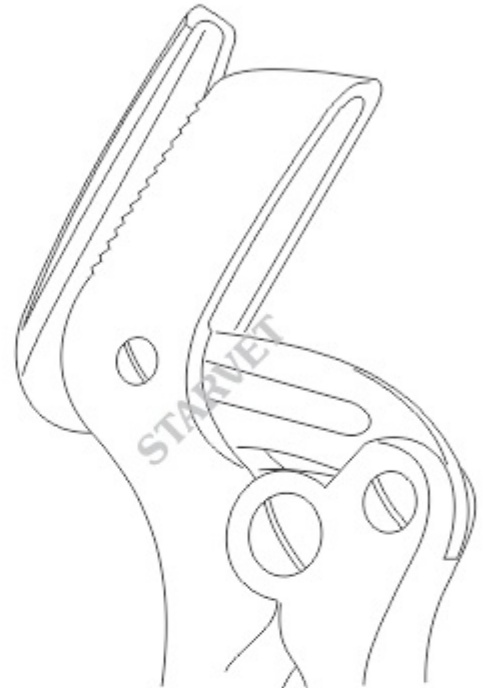

ST03-0044  
Blade with reinforced back  
ST03-0045  
Blade without reinforced back  
37 cm / 14½"



Stille



Stille-Mini  
ST03-0050  
Blade with reinforced back  
ST03-0051  
Blade without reinforced back  
20 cm / 8"



**Gerzog**  
ST03-0060  
18 cm / 7"  
250 gm



ST03-0065  
16.5 cm / 6½"  
140 gm / 5 oz  
20 mm Ø



**Collin**  
ST03-0070  
20 cm / 8"  
220 gm / 7¾ oz  
30 mm Ø



ST03-0080



**Mead**  
320 gm, 26 mm Ø  
ST03-0090  
Solid  
ST03-0091  
17 cm / 6¾"  
Ferrozell faces only, pair



**Heath**  
ST03-0100  
18.5 cm / 7¼"  
700 gm, 40 Ø mm  
Cooper filled head



**Williger**  
24 cm / 9½"

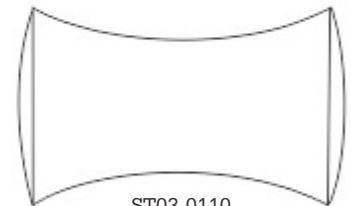

ST03-0110  
26 mm Ø  
300 gm / 10½ oz

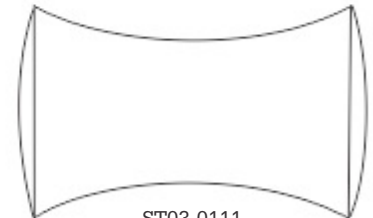

ST03-0111  
28 mm Ø  
340 gm / 12 oz

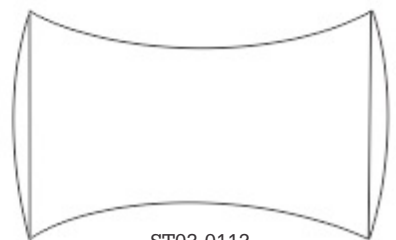

ST03-0112  
30 mm Ø  
400 gm / 14 oz



Autoclavable to  
250°F (121°C)

**Mallet Lightweight**  
ST03-0120  
19 cm / 7½"  
25 mm Ø, 140 gm

ST03-0121  
Two replaceable nylon caps  
Total weight: 7 oz.  
Head weight: 4 oz



**Aluminium handle**  
ST03-0130  
300 gm, 11 oz  
ST03-0131  
500 gm, 22 oz  
Heavy



**Cottle**  
ST03-0140 240 gm  
ST03-0141 300 gm  
ST03-0142 500 gm  
19 cm / 7½"  
30 mm



ST03-0150  
26 cm / 10½"  
510 gm / 18 oz  
ST03-0151  
300 gm



ST03-0160  
Head weight 350 gm  
Total weight 550 gm



ST03-0170  
Head weight 300 gm  
Total weight 500 gm



Periosteal Elevator  
ST03-0180



Periosteal Elevator  
ST03-0190



Periosteal Elevator  
ST03-0200



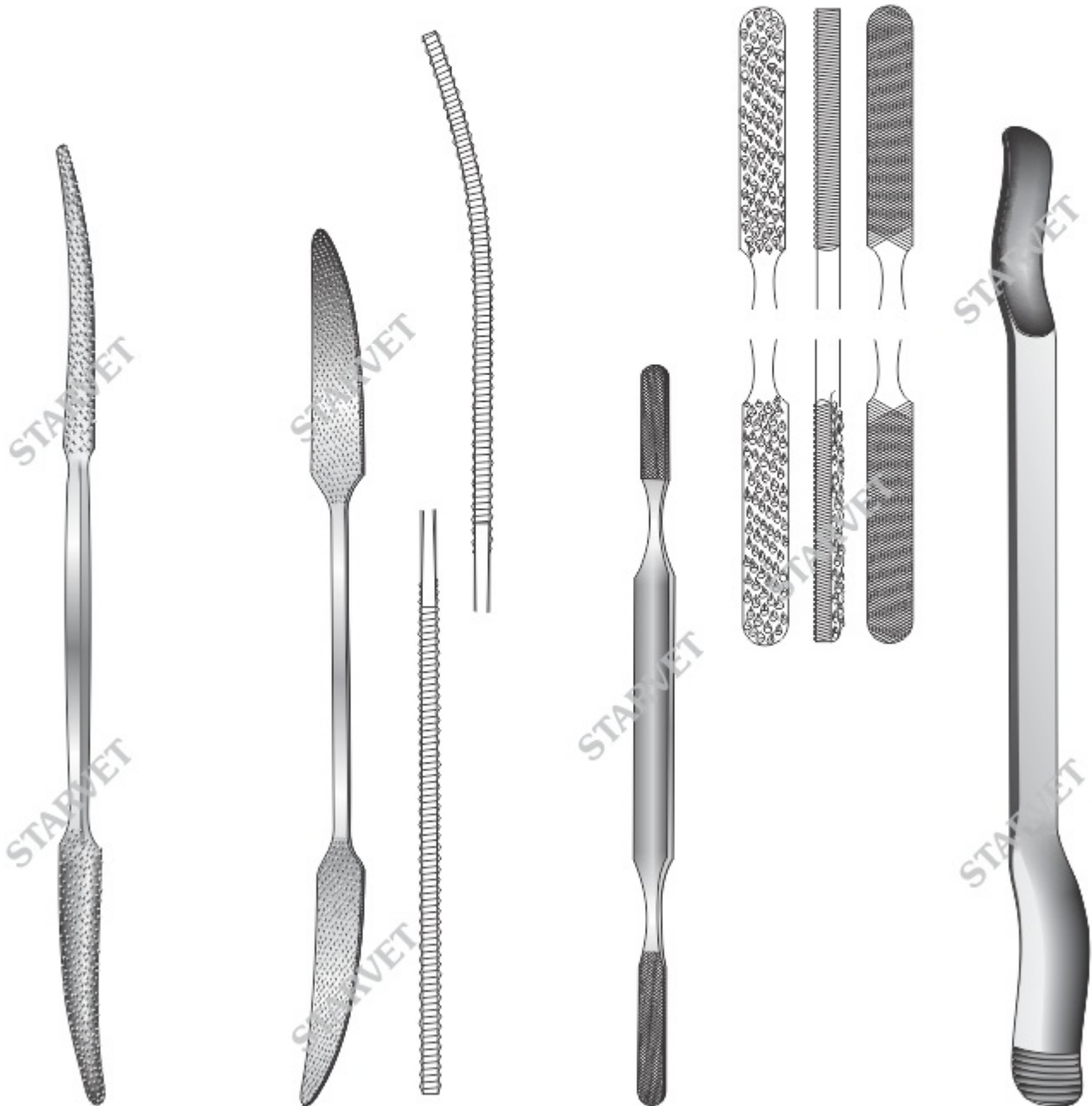

Putti  
ST03-0210  
30 cm / 12"

Putti  
ST03-0220  
27 cm / 10½"

Fomon  
ST03-0230  
21 cm / 8¼"  
Double ended, fine and  
coarse teeth 4-side, convex and flat  
blades 8 mm width

Murphy-Lane  
ST03-0240  
30 cm / 12"  
Bone skid



ST03-0300  
Fine, single ended  
8 mm width

Lewis Rasp  
19 cm / 7½"

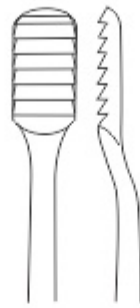

ST03-0301  
Coarse, single ended  
8 mm width  
plain serrations



Cottle Rasp  
ST03-0310  
20.5 cm / 8"  
Single ended, backward cutting  
9 mm width  
plain serrations

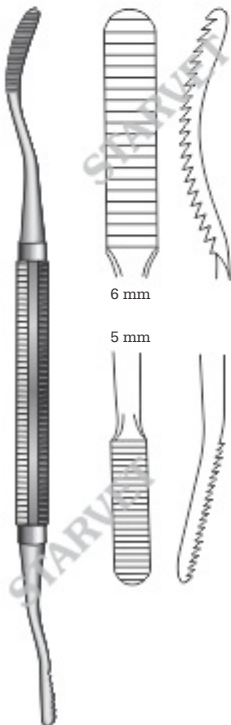

Miller-Colburn  
ST03-0320  
18.5 cm / 7¼"  
Double ended, plain serrations

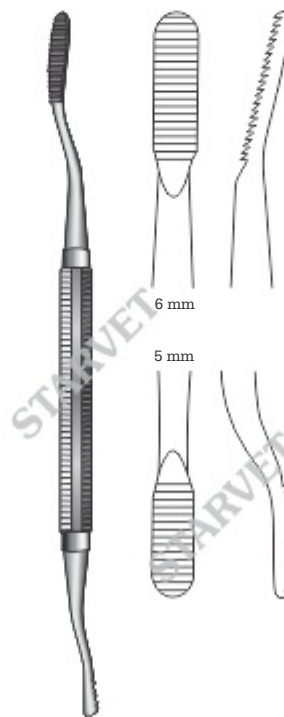

Miller-Colburn  
ST03-0330 5 mm / 7 mm  
ST03-0331 4 mm / 3 mm  
18 cm / 7"  
Double ended, plain serrations

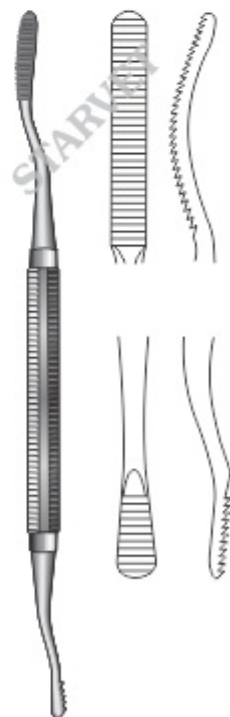

Miller-Colburn  
ST03-0340  
18 cm / 7"  
Double ended, 5 mm width,  
plain serrations



Gigli  
ST03-0350  
Handle

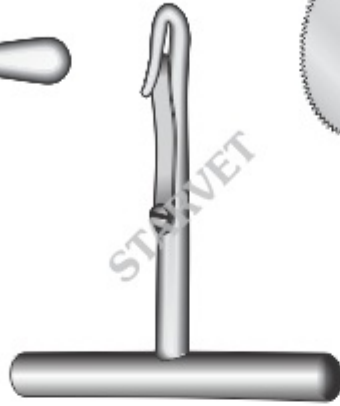

Gigli  
ST03-0355  
Handle with lock



Engel  
ST03-0360



Olivecrona  
ST03-0365 30 cm / 12"  
ST03-0366 40 cm / 16"  
ST03-0367 50 cm / 20"  
ST03-0368 70 cm / 28"

Gigli  
ST03-0370 30 cm / 12"  
ST03-0371 40 cm / 16"  
ST03-0372 50 cm / 20"  
ST03-0375 50 cm / 20"  
Fine, 6 wires twisted



Lindemann  
ST03-0380  
20 cm / 8"



Langenbeck  
ST03-0390  
23 cm / 9"



Charriere  
ST03-0400 27 cm / 10½"  
ST03-0401 30 cm / 12"  
ST03-0402 34 cm / 13½"



Satterlee  
ST03-0410  
30 cm / 12"  
Blade 23 cm / 9"



Charriere  
ST03-0420  
35 cm / 14"



ST03-0430



ST03-0440  
Set Of Five Blades



Saw Handle  
ST03-0450



Step 1



Step 2



Step 3



Bone Saw  
ST03-0460



ST03-0500



ST03-0470

Handle with chuck and key, accommodating up to 6.35 mm (1/4"), perforated, for inserting and extracting nails, guide pins and wire guide drills.



Handle  
ST03-0480



ST03-0490

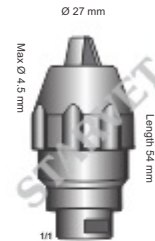

ST03-0510



Jacobs  
ST03-0520 Small  
ST03-0521 Large  
Stainless steel



ST03-0530  
Key for Jacobs chuck  
Stainless steel



ST03-0540 Small  
ST03-0541 Large  
Stainless steel  
ST03-0542 Small  
ST03-0543 Large  
Chrome plated



ST03-0550  
Key for chuck

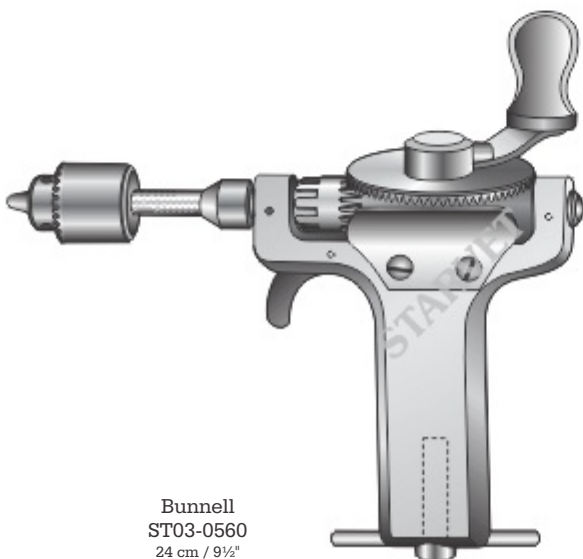

Bunnell  
ST03-0560  
24 cm / 9 1/2"

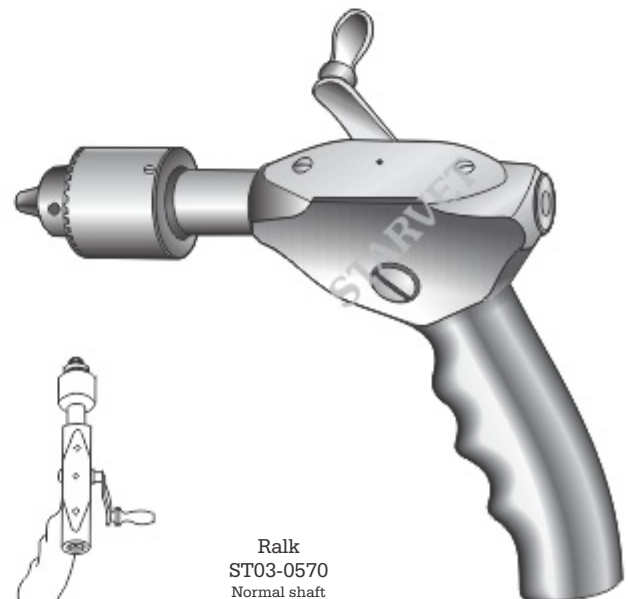

Ralk  
ST03-0570  
Normal shaft  
ST03-0571  
Long shaft



ST03-0580



ST03-0590  
Femoral Posthesis Pusher



ST03-0600  
Acetabular Cup Positioner



ST03-0610  
Twisterz Wire Twisters 155 mm



ST03-0620  
Wire tightener



ST03-0630  
Wire Tightener With Two  
Cranks 285 mm



Loute  
ST03-0640  
21 cm / 8¼"



Bone Mill  
ST03-0650



Bone Mill - Unassembled



ST03-0660  
Wire twister small  
Stainless steel



ST03-0670  
18 cm / 7"  
Large cerclage wire twister  
anodized aluminum handle  
Stainless steel tip



ST03-0680  
18 cm / 7"  
Small cerclage wire twister  
anodized aluminum handle



ST03-0690  
Large  
anodized aluminum handle



Bone Marker  
ST03-0700



ST03-0710  
Quick Release Handle



ST03-0720



Handle  
ST03-0730  
12 cm / 4 3/4"  
For 1.5 mm & 2 mm Tap (Dental Fit)



Slim Handle  
ST03-0740  
Quick Release Handle



ST03-0750  
Quick Release Handle



ST03-0760



Cruciate  
ST03-0770  
1.5 / 2.0 mm  
ST03-0771  
2.4 mm  
AO Type



Hex  
For Screws  
ST03-0780  
1.5 mm  
ST03-0781  
2.0 mm  
AO Type



Star  
ST03-0890  
2.00 mm  
ST03-0891  
2.5 mm  
ST03-0892  
3.5 mm



Countersink  
ST03-0800  
2.0 mm  
ST03-0801  
2.4 / 2.7 mm  
ST03-0802  
3.5 / 4.0 mm  
ST03-0803  
4.5 / 6.5 mm  
AO Type



Countersink T Handle  
ST03-0810 For Screws 1.5 / 2.0 mm  
ST03-0811 For Screws 2.7 / 3.5 mm  
13 cm / 5"  
ST03-0812 For Screws 4.5 mm  
17.5 cm / 7"

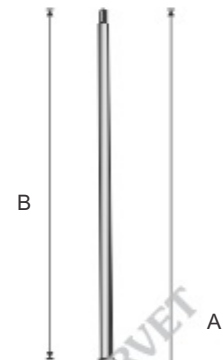

ST03-0820 1.5 mm - A = 45 mm / B = - 25 mm  
ST03-0821 2.0 mm - A = 50 mm / B = - 30 mm  
ST03-0822 2.4 mm - A = 55 mm / B = - 40 mm  
ST03-0823 2.7 mm - A = 75 mm / B = - 50 mm  
ST03-0824 3.5 mm - A = 120 mm / B = - 60 mm  
ST03-0825 4.5 mm - A = 130 mm / B = - 70 mm





- ST03-0830 Drill Bit 2.5 mm with 1.1 mm Cannulation
- ST03-0831 Drill Bit 2.7 mm with 1.1 mm Cannulation
- ST03-0832 Drill Bit 3.5 mm with 1.1 mm Cannulation Quick Release 130 mm
- ST03-0833 Drill Bit 2.5 mm with 1.1 mm Cannulation
- ST03-0834 Drill Bit 2.7 mm with 1.1 mm Cannulation
- ST03-0835 Drill Bit 3.5 mm with 1.1 mm Cannulation

- ST03-0840 Drill Bit 1.1 mm 60 mm Long
- ST03-0841 Drill Bit 1.5 mm 60 mm Long
- ST03-0842 Drill Bit 1.8 mm 80 mm Long
- ST03-0843 Drill Bit 2.0 mm 100 mm Long
- ST03-0844 Drill Bit 2.4 mm 115 mm Long
- ST03-0845 Drill Bit 2.5 mm 115 mm Long
- ST03-0846 Drill Bit 2.7 mm 130 mm Long
- ST03-0847 Drill Bit 3.0 mm 115 mm Long
- ST03-0848 Drill Bit 3.2 mm 130 mm Long
- ST03-0849 Drill Bit 3.5 mm 130 mm Long
- ST03-0850 Drill Bit 4.0 mm 145 mm Long
- ST03-0851 Drill Bit 4.5 mm 180 mm Long

- ST03-0860 Drill Bit 1.1 mm 100 mm Long
- ST03-0861 Drill Bit 1.5 mm 100 mm Long
- ST03-0862 Drill Bit 1.8 mm 100 mm Long
- ST03-0863 Drill Bit 1.9 mm 120 mm Long
- ST03-0864 Drill Bit 2.0 mm 140 mm Long
- ST03-0865 Drill Bit 2.3 mm 140 mm Long
- ST03-0866 Drill Bit 2.4 mm 150 mm Long
- ST03-0867 Drill Bit 2.5 mm 180 mm Long
- ST03-0868 Drill Bit 2.7 mm 180 mm Long
- ST03-0869 Drill Bit 3.0 mm 180 mm Long
- ST03-0870 Drill Bit 3.2 mm 180 mm Long
- ST03-0871 Drill Bit 3.8 mm 180 mm Long
- ST03-0872 Drill Bit 4.0 mm 180 mm Long
- ST03-0873 Drill Bit 4.5 mm 220 mm Long

- ST03-0880 1.1 mm Drill Bit 25 mm Flute
- ST03-0881 1.5 mm Drill Bit 40 mm Flute
- ST03-0882 2.0 mm Drill Bit 50 mm Flute
- ST03-0883 2.5 mm Drill Bit 55 mm Flute
- ST03-0884 2.7 mm Drill Bit 60 mm Flute
- ST03-0885 2.8mm Drill Bit 60 mm Flute
- ST03-0886 3.2 mm Drill Bit 60 mm Flute
- ST03-0887 3.5 mm Drill Bit 60 mm Flute

**AO Type Drill**

- ST03-0900 Bit 1.1 mm x 60 mm Long
- ST03-0901 Bit 1.5 mm x 60 mm Long
- ST03-0902 Bit 1.8 mm x 80 mm Long
- ST03-0903 Bit 2.0 mm x 100 mm Long
- ST03-0904 Bit 2.4 mm x 115 mm Long
- ST03-0905 Bit 2.5 mm x 115 mm Long
- ST03-0906 Bit 2.7 mm x 125 mm Long
- ST03-0907 Bit 3.2 mm x 145 mm Long
- ST03-0908 Bit 3.5 mm x 180 mm Long
- ST03-0909 Bit 4.0 mm x 180 mm Long
- ST03-0910 Bit 4.5 mm x 195 mm Long

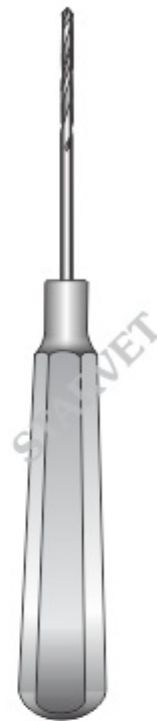

**Bone Tunnel Borer**

- ST03-0920 2 mm 160 mm
- ST03-0921 2.5 mm 165 mm
- ST03-0922 2.7 mm 165 mm
- ST03-0923 3.5 mm 180 mm



ST03-0930  
310 x 160 x 55 mm

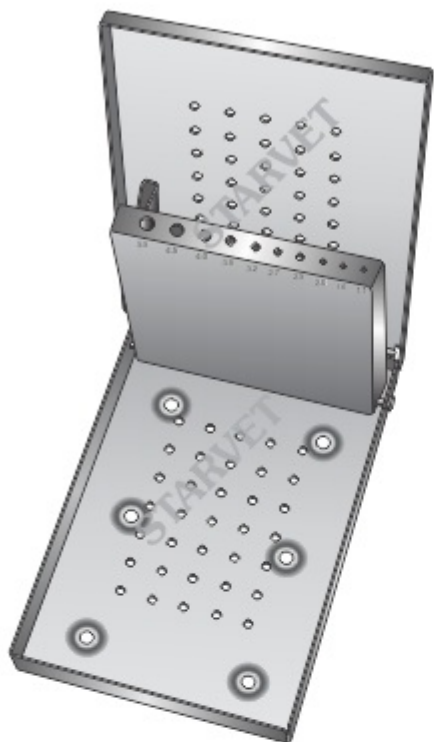

ST03-0940



ST03-0950

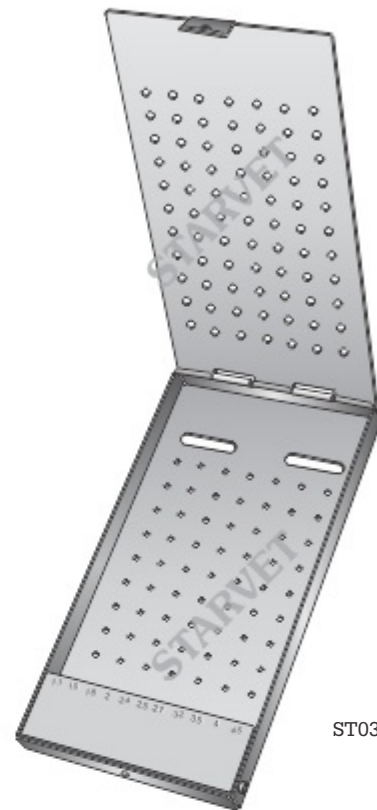

ST03-0960

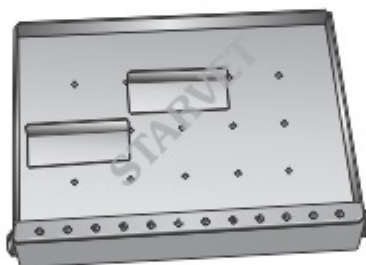

ST03-0970



ST03-0980

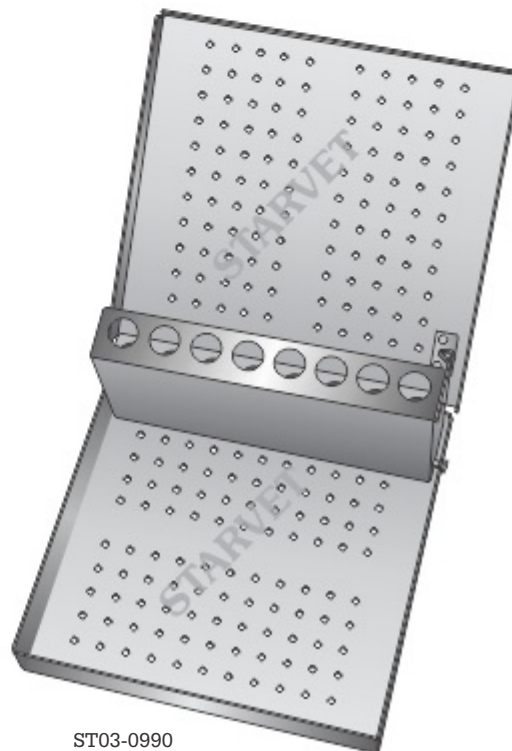

ST03-0990

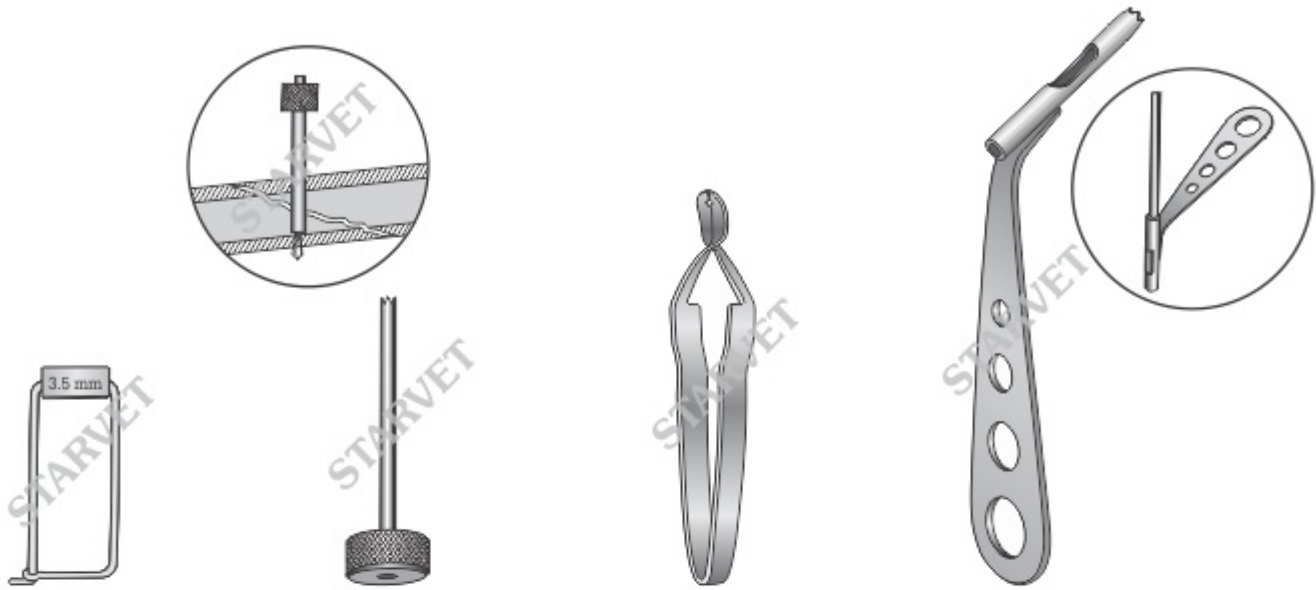

**Plate Holding Clip**  
 ST03-1000 2.0 mm  
 ST03-1001 2.4 mm  
 ST03-1002 2.7 mm  
 ST03-1003 3.5 mm  
 ST03-1004 4.5 mm

**Insert Sleeve**  
 ST03-1010 2.0 mm o/d 1.5 mm i/d  
 ST03-1011 2.4 mm o/d 1.8 mm i/d  
 ST03-1012 2.7 mm o/d 2.0 mm i/d  
 ST03-1013 3.5 mm o/d 2.0 mm i/d  
 ST03-1014 3.5 mm o/d 2.5 mm i/d  
 ST03-1015 3.5 mm o/d 2.7 mm i/d  
 ST03-1016 4.5 mm o/d 3.2 mm i/d  
 ST03-1017 5.5 mm o/d 4.0 mm i/d  
 ST03-1018 6.5 mm o/d 4.5 mm i/d

**Screw Holding Forceps**  
 ST03-1030 2.4/2.7/3.5/4.5 Screws  
 ST03-1031 1.0/1.5/2.0/2.4 Screws

**Drill Guide**  
 For Drill/Taps  
 ST03-1040 2.0 mm 90 mm  
 ST03-1041 3.5 mm 90 mm  
 ST03-1042 2.4 mm 90 mm  
 ST03-1043 4.5 mm 90 mm



**For Compression Plates**  
 ST03-1050 1.5 mm  
 ST03-1051 2.0 mm  
 ST03-1052 2.4 mm  
 ST03-1053 2.7 mm  
 ST03-1054 3.5 mm  
 ST03-1055 4.5 mm  
 ST03-1056 5.5 mm



**Triple Drill Guide/Sleeve**  
 ST03-1060 For 2.0 mm Drills  
 ST03-1061 For 2.5 mm Drills  
 11.5 cm / 4 1/2"



**Combination Drill, Tap & Insert Sleeve**  
 ST03-1070 For 2.0 Screws 100 mm  
 ST03-1071 For 2.4 Screws 105 mm  
 ST03-1072 For 2.7 Screws 110 mm  
 ST03-1073 For 3.5 Screws 115 mm  
 ST03-1074 For 4.5 Screws 130 mm



Size	Side 1		Side 2	
	Inner Dia	Outer Dia	Inner Dia	Outer Dia
ST03-1090 X-Large	3.5 mm	4.5 mm	2.5 mm	3.5 mm
ST03-1091 Large	2.7 mm	3.5 mm	2.0 mm	3.0 mm
ST03-1092 Medium	2.4 mm	3.5 mm	1.8 mm	2.5 mm
ST03-1093 Small	2.0 mm	2.6 mm	1.5 mm	2.3 mm



ST03-1080  
 Drill Guide 0.7 mm / 1.0 mm  
 ST03-1081  
 Double Drill Guide/Sleeve  
 For 1.1 & 1.5 mm, Drills 100 mm



ST03-1100  
Holding Forceps

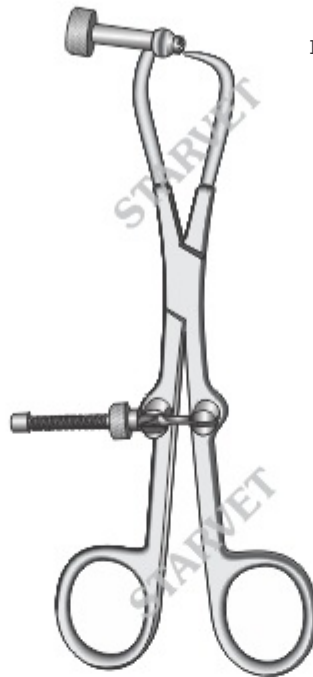

ST03-1110  
Plate Holding Forceps  
With Side screw  
14 cm / 5½"

For Plate thickness  
1.5 / 2.0 mm  
2.4 / 2.7 mm  
3.5 mm



ST03-1120  
Plate Holding Forceps  
With Ratchet  
14 cm / 5½"



Drill Guide  
ST03-1130  
Small Drill Guide i/d  
3.5 mm "C" Guide  
13.5 cm / 5¼"  
ST03-1131  
Large Drill Guide i/d  
6.5 mm "C" Guide  
14 cm / 5½"



Drill Guide  
ST03-1140  
Large Drill Guide i/d  
6.5 mm "C" Guide  
20 cm / 8"



Drill Guide  
ST03-1150  
Small Drill Guide i/d  
3.5 mm "C" Guide  
18 cm / 7"



Cruciate  
ST03-1160  
20 cm / 8"  
ST03-1161  
25 cm / 10"



Flat  
ST03-1170  
25 cm / 10"  
ST03-1171  
20 cm / 8"  
Ferrozell handle



Flat  
ST03-1180  
13 cm / 5"  
ST03-1181  
20 cm / 8"  
ST03-1182  
23 cm / 9"  
Ferrozell handle



Cruciate  
ST03-1190  
Screw Driver  
For 2.4 mm screws



Cruciate  
ST03-1200  
Screw Driver  
For 1.5 / 2.0mm screws



Handle 1

Hex Screwdriver with Handle No. 1

With Sleeve				
Length	Head Size			
	1.5 mm	2.0 mm	2.5 mm	3.5 mm
12.5 cm	ST03-1210	ST03-1213	-	-
20.0 cm	ST03-1211	ST03-1214	ST03-1216	ST03-1218
25.0 cm	ST03-1212	ST03-1215	ST03-1217	ST03-1219

Without Sleeve				
Length	Head Size			
	1.5 mm	2.0 mm	2.5 mm	3.5 mm
12.5 cm	ST03-1230	ST03-1233	-	-
20.0 cm	ST03-1231	ST03-1234	ST03-1236	ST03-1238
25.0 cm	ST03-1232	ST03-1235	ST03-1237	ST03-1239



Hex Screwdriver with Handle No. 2

With Sleeve				
Length	Head Size			
	1.5mm	2.0mm	2.5mm	3.5mm
12.5 cm	ST03-1250	ST03-1253	-	-
20.0 cm	ST03-1251	ST03-1254	ST03-1256	ST03-1258
25.0 cm	ST03-1252	ST03-1255	ST03-1257	ST03-1259

Without Sleeve				
Length	Head Size			
	1.5mm	2.0mm	2.5mm	3.5mm
12.5 cm	ST03-1270	ST03-1273	-	-
20.0 cm	ST03-1271	ST03-1274	ST03-1276	ST03-1278
25.0 cm	ST03-1272	ST03-1275	ST03-1277	ST03-1279



Handle 2

All these Ferrozal handle shapes are available in following Colors  
Black, Green, White, Grey, Blue, Yellow, Brown



Handle 3

Hex Screwdriver with Handle No. 3

With Sleeve				
Length	Head Size			
	1.5 mm	2.0 mm	2.5 mm	3.5 mm
12.5 cm	-	-	-	-
20.0 cm	ST03-1290	ST03-1292	ST03-1294	ST03-1296
25.0 cm	ST03-1291	ST03-1293	ST03-1295	ST03-1297

Without Sleeve				
Length	Head Size			
	1.5 mm	2.0 mm	2.5 mm	3.5 mm
12.5 cm	-	-	-	-
20.0 cm	ST03-1310	ST03-1312	ST03-1314	ST03-1316
25.0 cm	ST03-1311	ST03-1313	ST03-1315	ST03-1317



Hex Screwdriver with Handle No. 4

With Sleeve				
Length	Head Size			
	1.5 mm	2.0 mm	2.5 mm	3.5 mm
12.5 cm	-	-	-	-
20.0 cm	ST03-1330	ST03-1332	ST03-1334	ST03-1336
25.0 cm	ST03-1331	ST03-1333	ST03-1335	ST03-1337

Without Sleeve				
Length	Head Size			
	1.5 mm	2.0 mm	2.5 mm	3.5 mm
12.5 cm	-	-	-	-
20.0 cm	ST03-1350	ST03-1352	ST03-1354	ST03-1356
25.0 cm	ST03-1351	ST03-1353	ST03-1355	ST03-1357



Handle 4



ST03-1370



Star  
ST03-1380  
2.0 mm  
Screw Driver



Star  
ST03-1390  
2.5 mm  
Screw Driver



Star  
ST03-1400  
3.0 mm  
Screw Driver



ST03-1410



ST03-1420



Cruciate  
ST03-1430 1.5 / 2.0 mm  
ST03-1431 2.4 mm



Hex  
ST03-1440 1.5 mm  
ST03-1441 2.0 mm



Star  
ST03-1450 2.0 mm  
ST03-1451 2.5 mm  
ST03-1452 3.5 mm



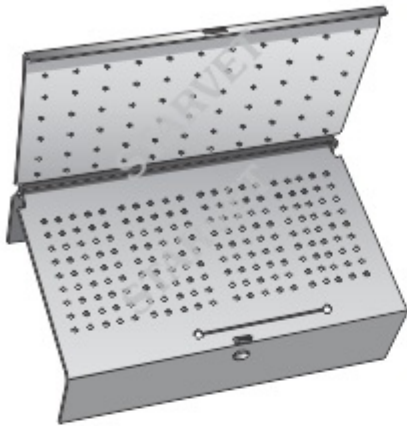

ST03-1460  
1.5/2.0/2.4/2.7 mm



ST03-1470  
Box for two inserts



ST03-1480 1.5 mm  
ST03-1481 2.0 mm  
ST03-1482 2.4 mm  
ST03-1483 2.7 mm  
ST03-1484 3.5 mm  
ST03-1485 4.5 mm



ST03-1490  
Box for single inserts

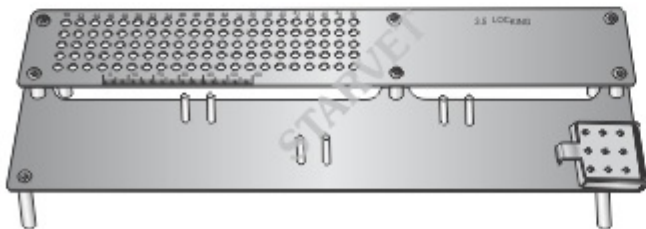

Insert  
ST03-1500 1.5 mm screws  
ST03-1501 2.0 mm screws  
ST03-1502 2.4 mm screws  
ST03-1503 2.7 mm screws  
ST03-1504 3.5 mm screws

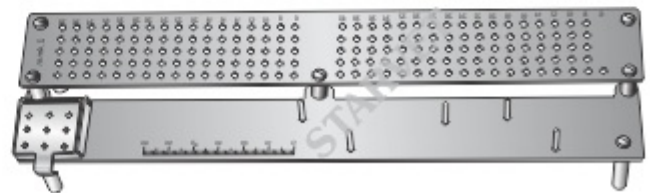

Insert  
ST03-1510 1.5 / 2.0 mm  
ST03-1511 2.4 / 2.7 mm  
ST03-1512 2.7 / 3.5 mm

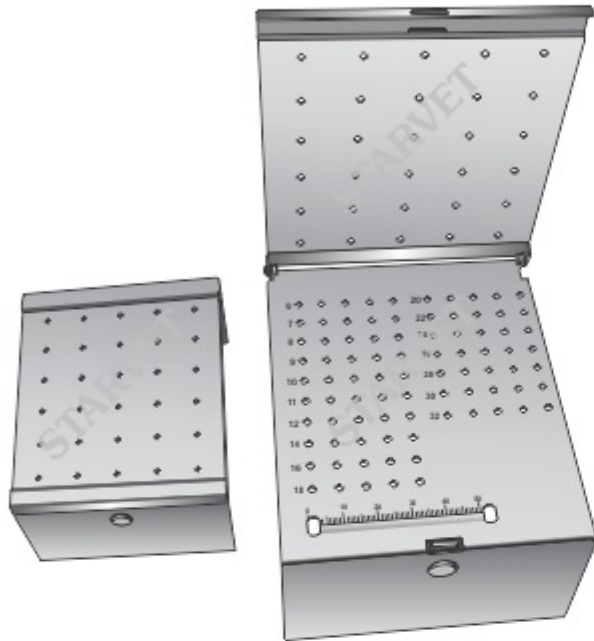

Mini Screw Rack

ST03-1520	1.5 mm
ST03-1521	2.0 mm
ST03-1522	2.4 mm
ST03-1523	2.7 mm
ST03-1524	3.5 mm



ST03-1530  
Box for two inserts

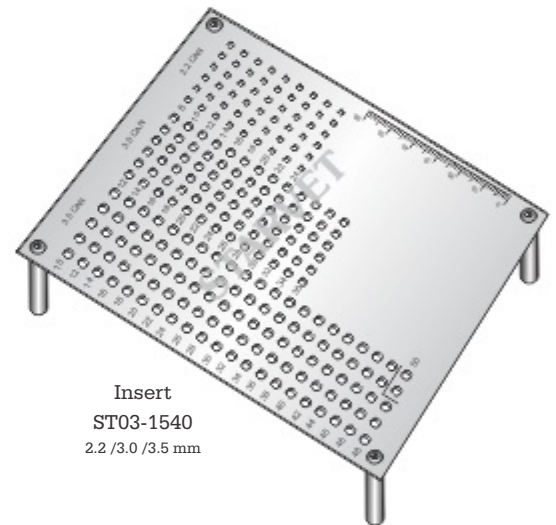

Insert  
ST03-1540  
2.2 / 3.0 / 3.5 mm

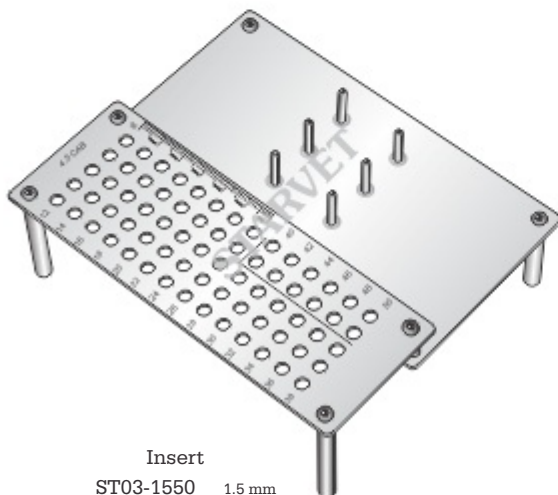

Insert	
ST03-1550	1.5 mm
ST03-1551	2.0 mm
ST03-1552	1.5 / 2.0 mm
ST03-1553	2.4 mm
ST03-1555	2.7 mm
ST03-1555	3.5 mm
ST03-1556	4.5 mm
ST03-1557	5.5 mm



Insert  
ST03-1570  
For 4.0 mm screws

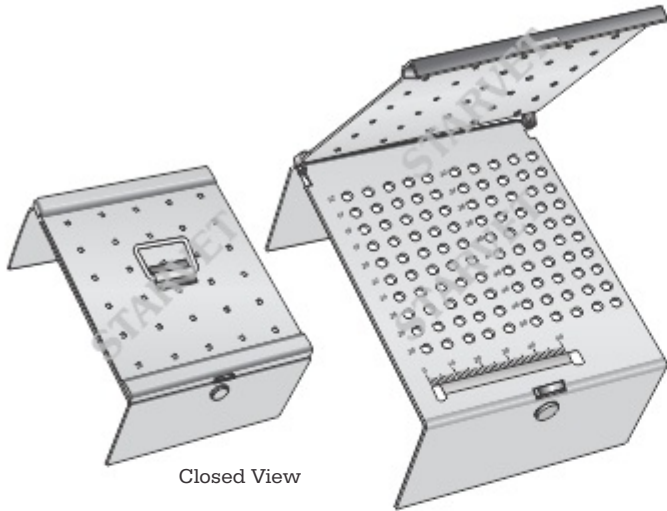

Closed View

Screw Rack

ST03-1580	1.5 mm screws
ST03-1581	2.0 mm screws
ST03-1582	2.4 mm screws
ST03-1583	2.7 mm screws
ST03-1584	3.5 mm screws
ST03-1585	4.5 mm screws



ST03-1590  
Box for two inserts

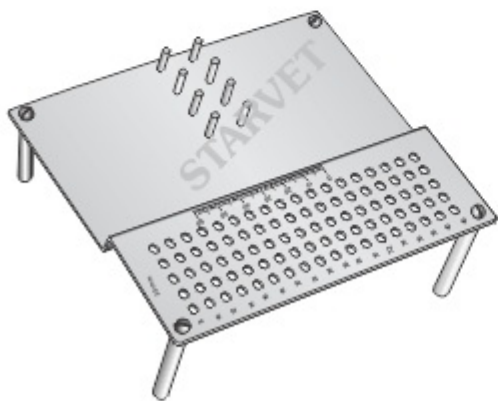

Insert

ST03-1600	1.5 mm
ST03-1601	2.0 mm
ST03-1602	1.5/2.0 mm
ST03-1603	2.4 mm
ST03-1604	2.7 mm
ST03-1605	3.5 mm
ST03-1606	4.5 mm

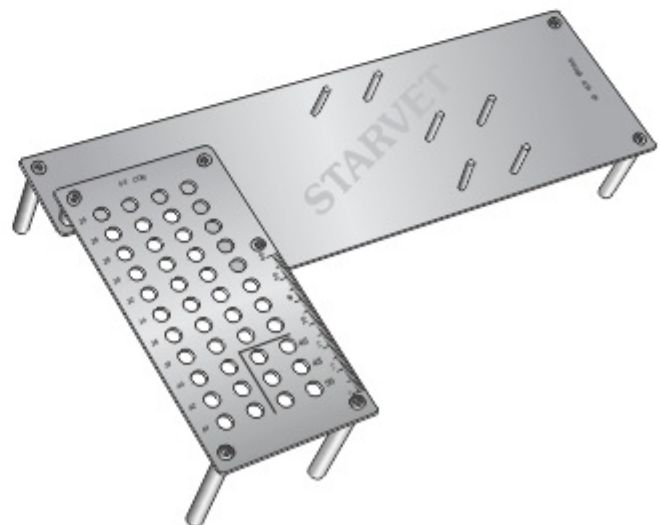

ST03-1620

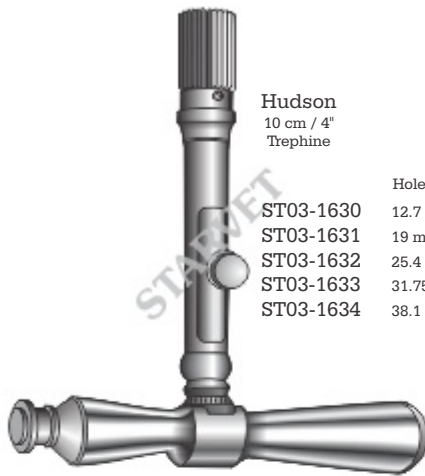

**Hudson**  
10 cm / 4"  
Trepine

Hole size

ST03-1630	12.7 mm / 1/2"
ST03-1631	19 mm / 3/4"
ST03-1632	25.4 mm / 1"
ST03-1633	31.75 mm / 1 1/4"
ST03-1634	38.1 mm / 1 1/2"



**Michele**  
Trepine

		Inside Ø	Outside Ø
ST03-1640	Small	3 mm	5 mm
ST03-1641	Medium	4 mm	6 mm
ST03-1642	Large	6 mm	8 mm

Facilitates removal of wire and broken bone screws.

**Depth Gauge**

- ST03-1655 For 1.5 mm & 2.0 mm Screws
- ST03-1656 For 2.0 mm & 2.7 mm Screws
- ST03-1657 For 2.4, 2.7 & 3.5 mm Screws
- ST03-1658 For 2.7 & 3.5 mm Screws
- ST03-1659 For 4.5 & 6.5 mm Screws



ST03-1650 100 mm  
ST03-1651 50 mm  
Aluminum type



ST03-1660  
40 mm  
For 1.5 mm & 2.0 mm Screws  
115 mm



ST03-1670  
60 mm  
For 2.4, 2.7 & 3.5 mm Screws  
180 mm



ST03-1680  
80 mm  
For 2.7 & 3.5 mm Screws  
175 mm



ST03-1690  
110 mm  
For 4.5 & 6.5 mm Screws  
290 mm

ST03-1661  
For 2.0 mm & 2.7 mm Screws  
135 mm

ST03-1671  
For 2.7 & 3.5 mm Screws  
175 mm



ST03-1701  
Fig. 00000

ST03-1702  
Fig. 0000

ST03-1703  
Fig. 000

ST03-1704  
Fig. 00

ST03-1705  
Fig. 0

**Lempert**  
17.5 cm / 6½"  
Bone Curette



**ST03-1710**  
21 cm / 8¼"



**Williger**  
13.5 cm / 5¼"

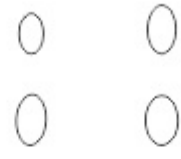

ST03-1715 ST03-1716  
Fig. 00/0 Fig. 0/1



ST03-1717  
Fig. 1 / 2



**Martini**  
ST03-1720  
14 cm / 5½"



ST03-1730  
13 cm / 5"



ST03-1731  
14 cm / 5½"



ST03-1732  
17 cm / 6¾"



ST03-1740  
13 cm / 5"



ST03-1741  
16 cm / 6¼"



ST03-1742  
20 cm / 8"



ST03-1750



**Volkman**  
17 cm / 6 3/4"

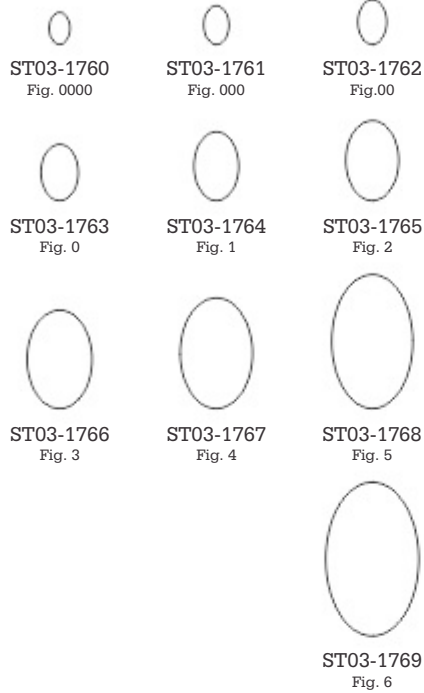

**Spratt**  
17 cm / 6 3/4"

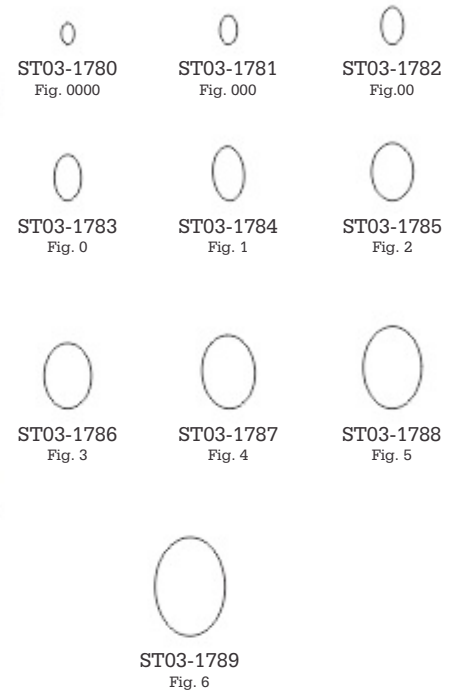

**Bruns**  
17 cm / 6 3/4"

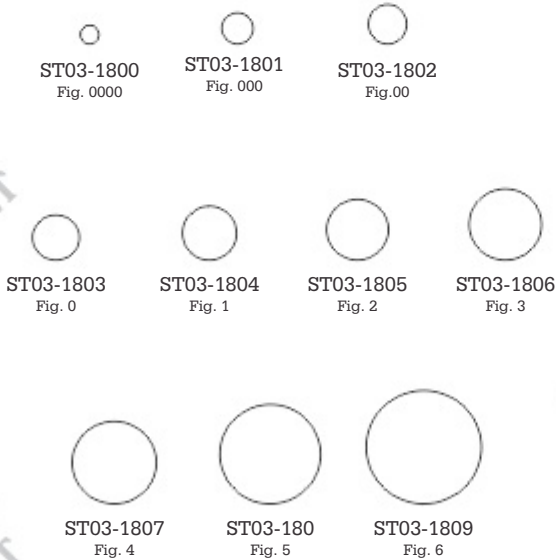

ST03-1820 10 x 14 x 230 mm, Small  
ST03-1821 20 x 25 x 250 mm, Medium  
ST03-1822 67 x 34 x 270 mm, Large



**Hatt Spoon**  
ST03-1830 20 x 34 mm Scoop  
ST03-1831 17 x 30 mm Scoop  
ST03-1832 12 x 18 mm Scoop  
ST03-1833 7 x 12 mm Scoop  
23 cm / 9"

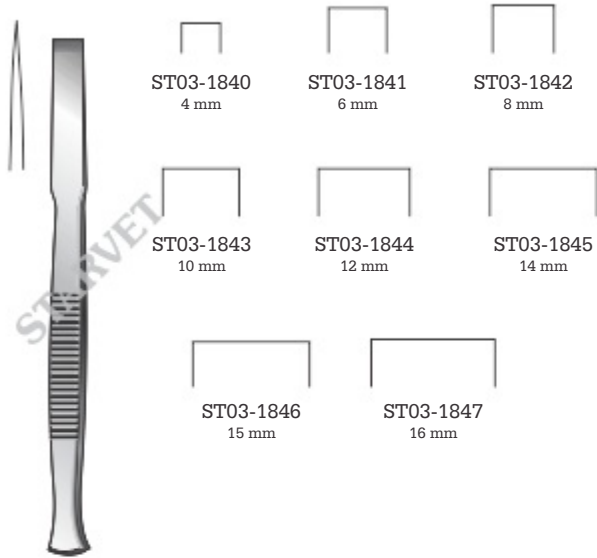

13.5 cm / 5¼"  
Osteotomes

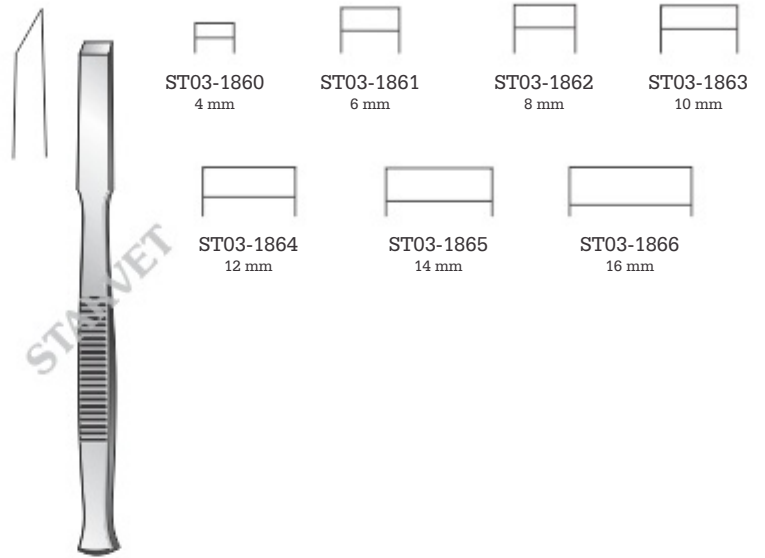

13.5 cm / 5¼"  
Chisels

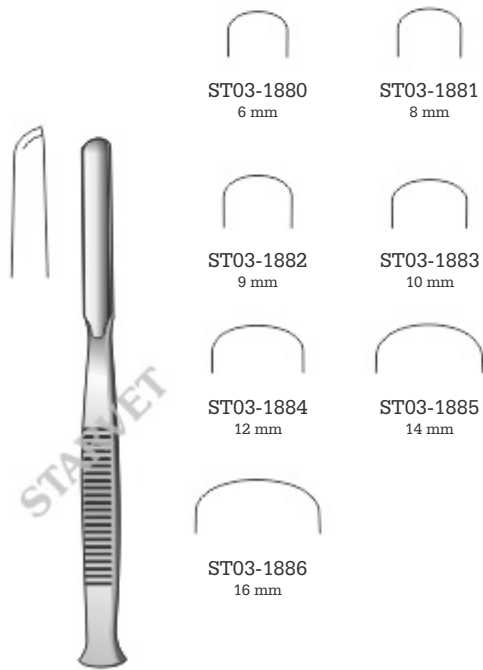

13.5 cm / 5¼"  
Gouges

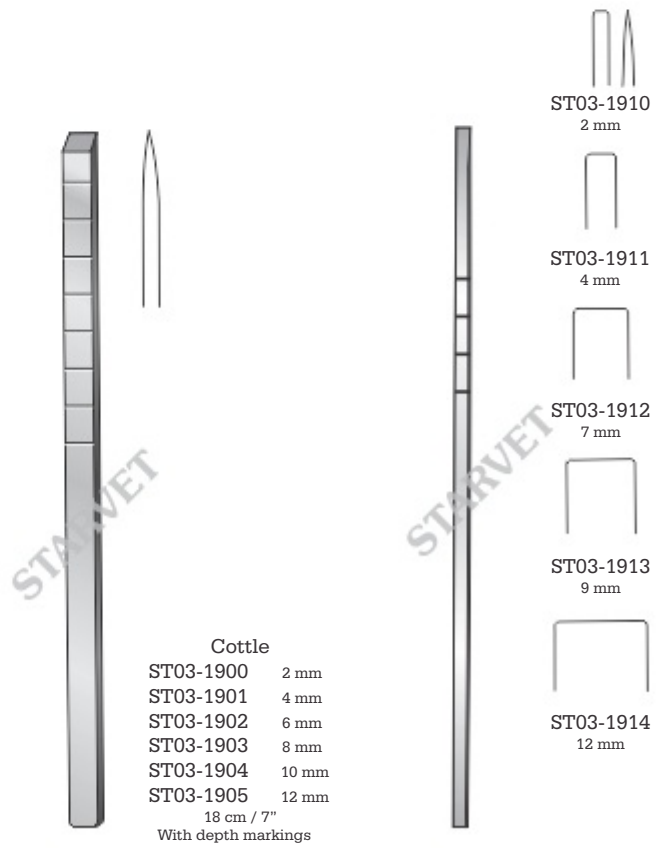

**Cottle**  
18 cm / 7"  
Osteotome

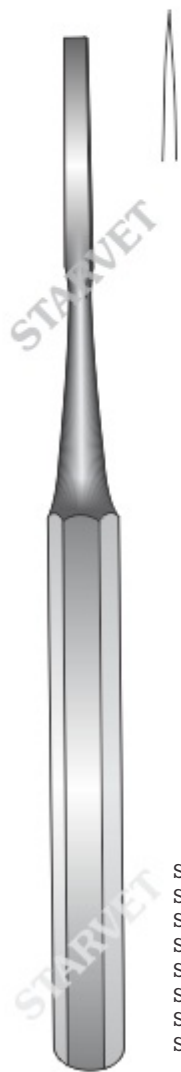

**Hoke**  
Osteotome

ST03-1920	2 mm
ST03-1921	4 mm
ST03-1922	6 mm
ST03-1923	8 mm
ST03-1924	10 mm
ST03-1925	12 mm
ST03-1926	14 mm
ST03-1927	19 mm

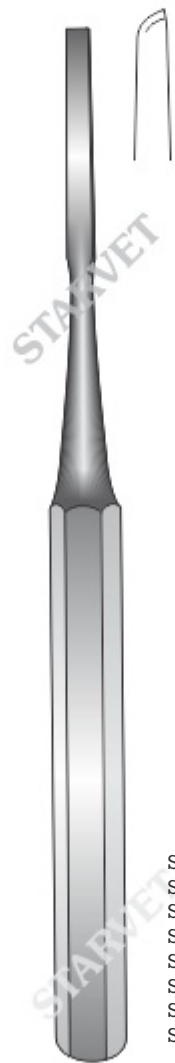

**Hoke**  
Gouges

ST03-1940	2 mm
ST03-1941	4 mm
ST03-1942	6 mm
ST03-1943	8 mm
ST03-1944	10 mm
ST03-1945	12 mm
ST03-1946	14 mm
ST03-1947	19 mm

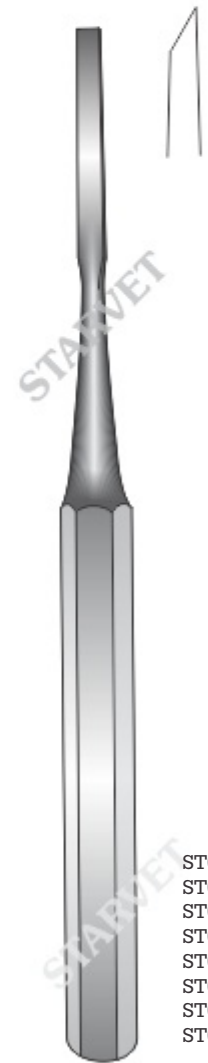





**Hoke**  
Chisels





ST03-1960	2 mm
ST03-1961	4 mm
ST03-1962	6 mm
ST03-1963	8 mm
ST03-1964	10 mm
ST03-1965	12 mm
ST03-1966	14 mm
ST03-1967	19 mm



 ST03-1980  
2 mm  
 ST03-1981  
3 mm  
 ST03-1982  
4 mm  
 ST03-1983  
6 mm

 ST03-1984  
8 mm  
 ST03-1985  
10 mm  
 ST03-1986  
12 mm  
 ST03-1987  
15 mm







**Mini-Lambotte**  
12.5 cm / 5"  
Osteotome

 ST03-2000  
2 mm  
 ST03-2001  
3 mm  
 ST03-2002  
4 mm  
 ST03-2003  
6 mm







 ST03-2004  
8 mm  
 ST03-2005  
10 mm  
 ST03-2006  
12 mm

 ST03-2007  
15 mm  
 ST03-2008  
18 mm

**Mini-Lambotte**  
17 cm / 6 3/4"  
Osteotome

 ST03-2020  
15 mm  
 ST03-2021  
20 mm  
 ST03-2022  
25 mm  
 ST03-2023  
30 mm  
 ST03-2024  
38 mm  
 ST03-2025  
44 mm  
 ST03-2026  
50 mm

**Lambotte**  
24 cm / 9 1/2"  
Straight  
Osteotome

 ST03-2040  
15 mm  
 ST03-2041  
20 mm  
 ST03-2042  
25 mm  
 ST03-2043  
30 mm  
 ST03-2044  
38 mm  
 ST03-2045  
44 mm  
 ST03-2046  
50 mm

**Lambotte**  
24 cm / 9 1/2"  
Curved  
Osteotome

Add "N" to the item code for Teflon Handle.



**Stille-Chisels**

ST03-2060	10 mm
ST03-2061	12 mm
ST03-2062	15 mm
ST03-2063	20 mm
ST03-2064	25 mm
20.5 cm / 8" Chisels	

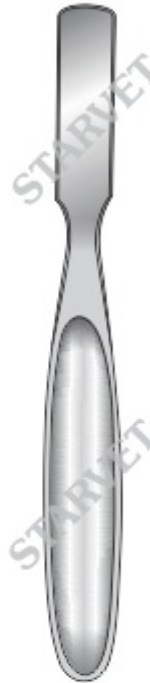

**Bone Skid**

ST03-2070	3 mm
ST03-2071	5 mm
ST03-2072	7 mm
ST03-2073	9 mm
ST03-2074	11 mm
ST03-2075	13 mm
ST03-2076	15 mm
ST03-2077	17 mm
ST03-2078	19 mm
16.5 cm / 6"	



**Stille-Gouge**

ST03-2090	10 mm
ST03-2091	12 mm
ST03-2092	15 mm
ST03-2093	20 mm
ST03-2094	25 mm
20.5 cm / 8" Gouges	



**Stille-Osteome**

ST03-2100	8 mm
ST03-2101	10 mm
ST03-2102	12 mm
ST03-2103	15 mm
ST03-2104	20 mm
ST03-2105	25 mm
20.5 cm / 8" Osteotomes	

Add "N" to the item code for Teflon Handle.



Mini-Lexer  
18 cm / 7"  
Ferrozell handle

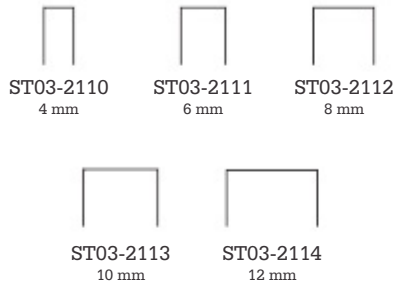

Mini-Lexer  
18 cm / 7"  
Ferrozell handle

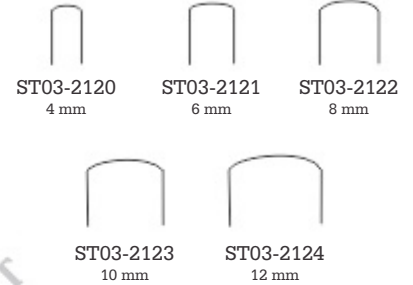

Lexer  
22 cm / 8 3/4"  
Ferrozell handle

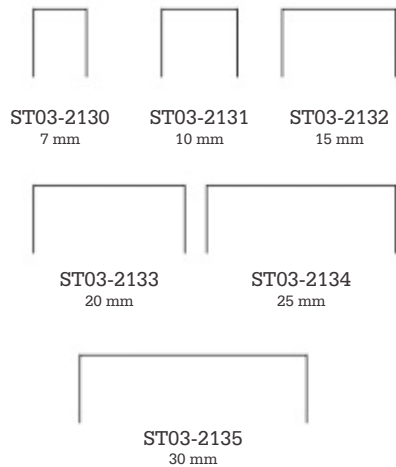

Lexer  
22 cm / 8 3/4"  
Ferrozell handle

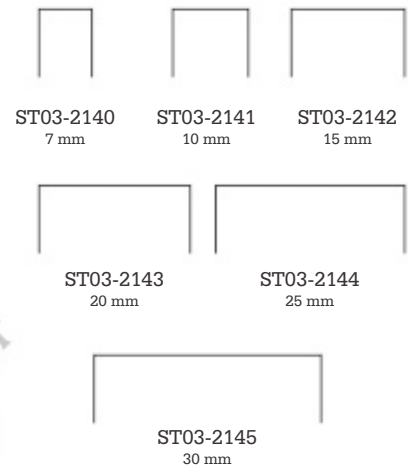

Add "N" to the item code for Teflon Handle



Osteotome blades,  
interchangeable



4 mm  
ST03-2151  
8.5 cm / 3¼"



6 mm  
ST03-2152  
8.5 cm / 3¼"



8 mm  
ST03-2153  
8.5 cm / 3¼"



10 mm  
ST03-2154  
8.5 cm / 3¼"



12 mm  
ST03-2155  
8.5 cm / 3¼"

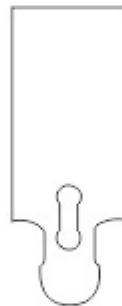

15 mm  
ST03-2156  
8.5 cm / 3¼"



20 mm  
ST03-2157  
8.5 cm / 3¼"

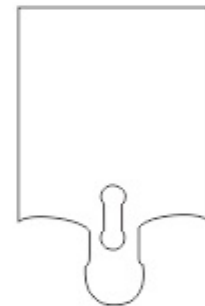

25 mm  
ST03-2158  
8.5 cm / 3¼"



ST03-2150  
18.5 cm / 7¼"  
Handle, only  
Ferrozell handle



ST03-2170  
9 cm / 3½"  
Key  
ST03-2171  
Spare Screw

Add "N" to the item code for Teflon Handle. Add "Z" to the item code for Ferrozell Handle.



ST03-2180



6 mm

ST03-2190  
18 cm / 7"  
Ferozell handle



6 mm

ST03-2200  
18 cm / 7"  
Ferozell handle



3 mm

ST03-2210  
18 cm / 7"  
Ferozell handle

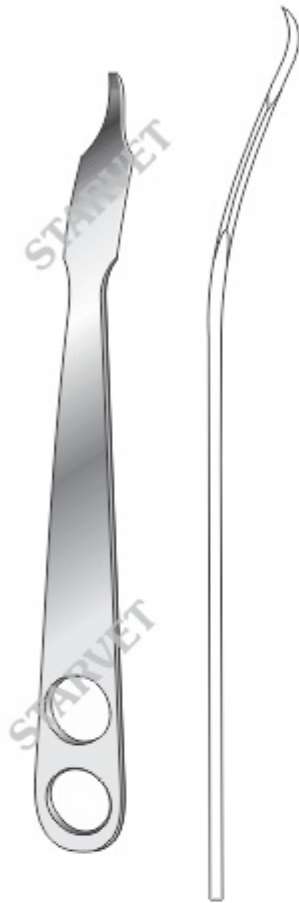

Hohmann  
ST03-2220 18 mm  
ST03-2221 11 mm  
24 cm / 9½"



Hohmann  
ST03-2230  
12 mm  
17.5 cm / 7"



Hohmann  
ST03-2240  
25 mm  
12 cm / 4¾"

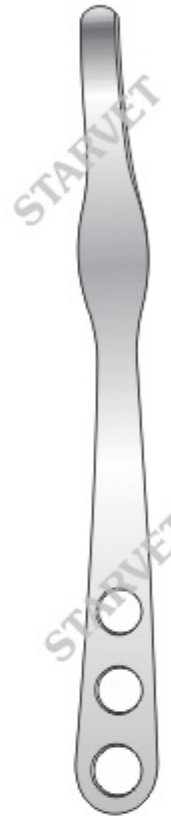

Hohmann  
ST03-2250  
24 mm  
28 cm / 11"



Hohmann  
ST03-2260  
18 mm  
17.5 cm / 7"



Hohmann  
ST03-2270  
20 mm  
20 cm / 8"



Hohmann  
ST03-2280 25.5 cm / 10"  
25 x 36 mm, large  
ST03-2281 17.5 cm / 7"  
13 x 18 mm, medium  
ST03-2282 12.5 cm / 5"  
8 x 12 mm, small



**Hohmann**  
ST03-2290 48 mm  
26 cm / 10¼"  
ST03-2291 24 mm  
24 cm / 9½"  
ST03-2292 8 mm  
16.5 cm / 6½"



**Mini Hohmann**  
ST03-2300  
16.5 cm / 6½"  
6 mm



**Micro Hohmann**  
ST03-2310  
4 mm  
16 cm / 6¼"



**Swan-Neck Hohman**  
ST03-2320  
11 mm Blade  
Medium



**Gutter Hohman Retractor**  
ST03-2330  
18 cm / 7"



**Disarticulator**  
ST03-2340 Small  
14.5 cm / 5¾"  
ST03-2341 Large  
19.5 cm / 7¾"



9.5 cm / 3 3/4"  
Reposition forceps  
with stepped tips

ST03-2350

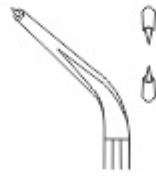

ST03-2351

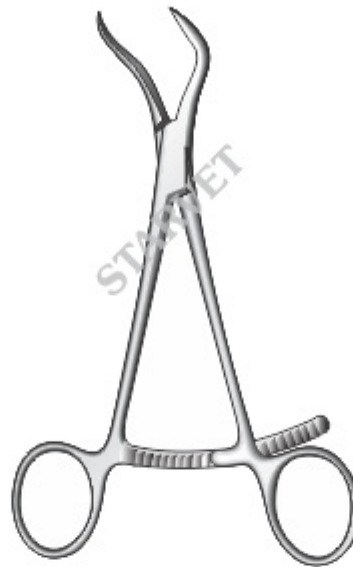

ST03-2360  
13.5 cm / 5 1/2"



Ikuta  
ST03-2370  
Bone Holding Forceps  
ST03-2371 2 mm ST03-2372  
ST03-2373 3 mm ST03-2374  
Straight Curved  
12.5 cm / 5"



Bone Holding Forceps  
ST03-2380 17 cm / 6 3/4"  
ST03-2381 21 cm / 8 1/4"  
With Spin Lock

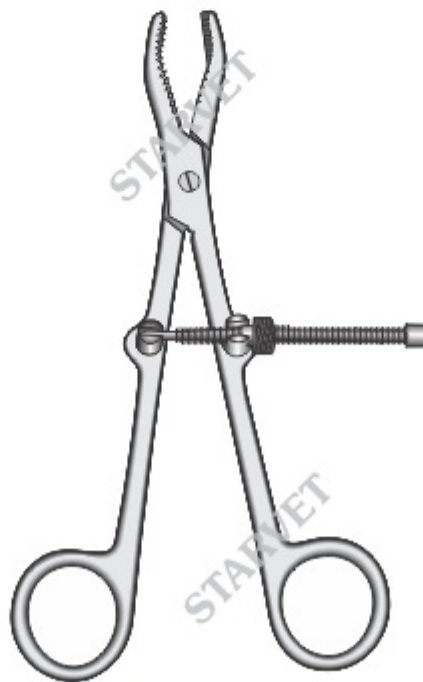

Bone Holding Forceps  
ST03-2390  
With Spin Lock



Bone Holding Forceps  
ST03-2400



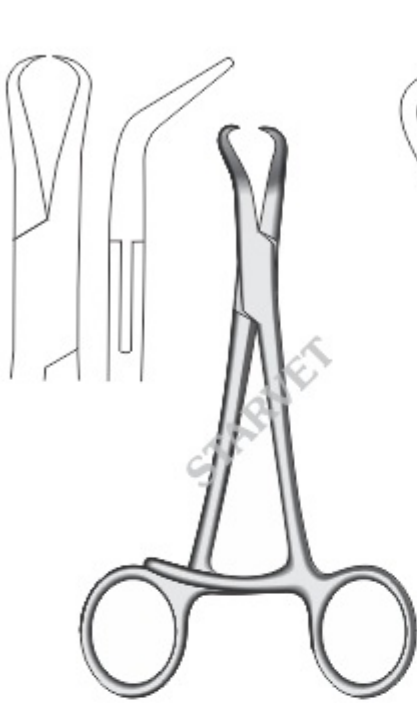

**Stagbeetle**  
ST03-2410  
12 cm / 4 3/4"  
Bone reduction forceps  
Curved, pointed tips

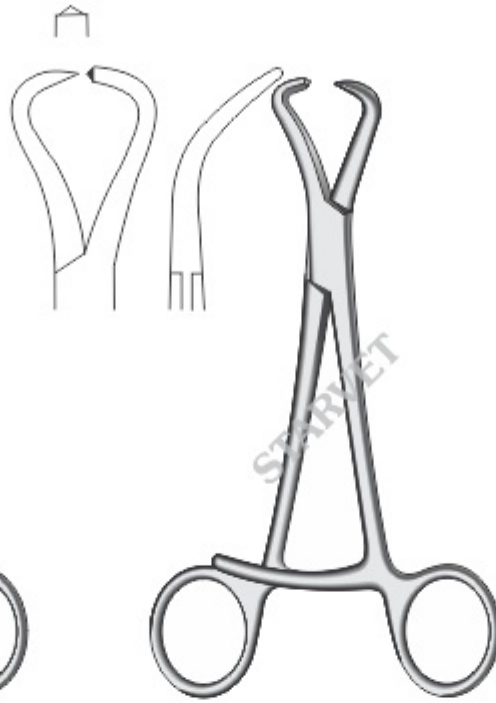

**Bone Reduction Forceps**  
ST03-2420 14 cm / 5 1/2"  
ST03-2421 16.5 cm / 6 1/2"  
Curved



**Bone Holding Forceps**  
ST03-2430 13.5 cm / 5 1/4"  
ST03-2431 18 cm / 7"  
ST03-2432 21 cm / 8 1/4"  
With Spin Lock



ST03-2440 13.5 cm / 5 1/4"  
ST03-2441 16 cm / 6 1/4"  
ST03-2442 18 cm / 7"  
ST03-2443 20 cm / 8"



**Bone Holding Forceps**  
ST03-2450 15 cm / 6"  
ST03-2451 17.5 cm / 7"  
ST03-2452 20 cm / 8"

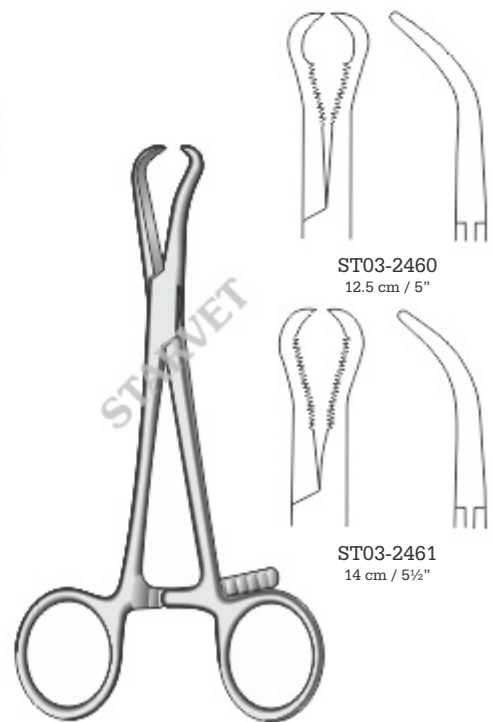

**Bone holding forceps**  
Serrated with pointed tips  
Curved

ST03-2460  
12.5 cm / 5"

ST03-2461  
14 cm / 5 1/2"

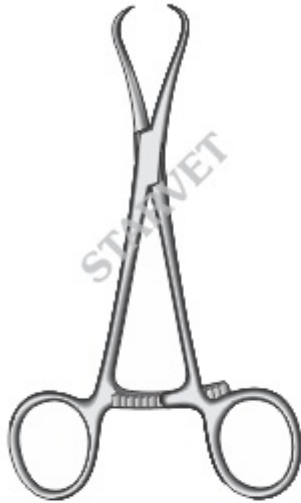

Steinhauser  
ST03-2470  
13 cm / 5"



Steinhauser  
ST03-2480  
13 cm / 5"

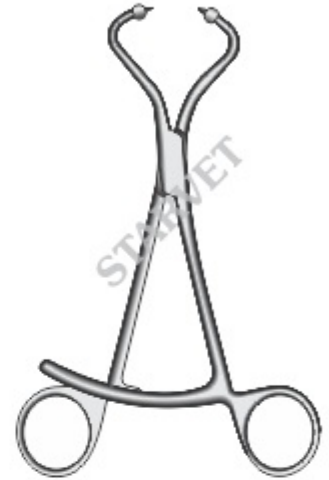

ST03-2490  
16 cm / 6¼"  
Plate Holding Forceps

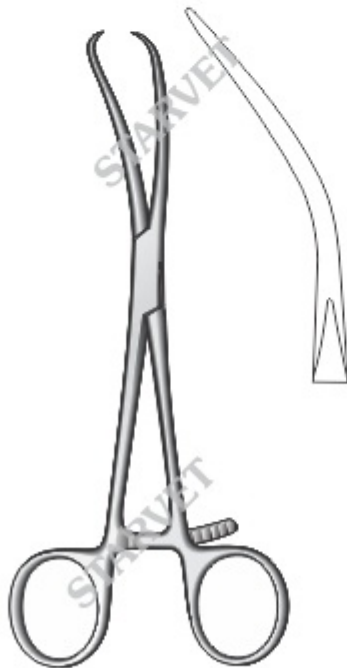

Reill  
ST03-2500  
17.5 cm / 7"  
Bone reposition forceps  
Curved, pointed tips



ST03-2510  
20 cm / 8"  
Plate Holding Forceps

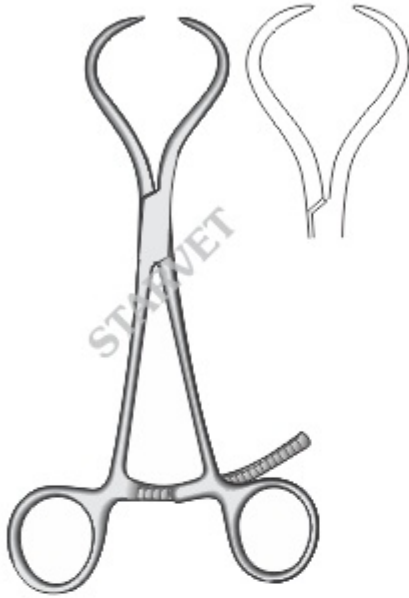

ST03-2520  
16 cm / 6¼"  
Bone fragment forceps



ST03-2530 16 cm / 6¼"  
ST03-2531 18 cm / 7"  
Bone Holding Forceps  
With Spin Lock

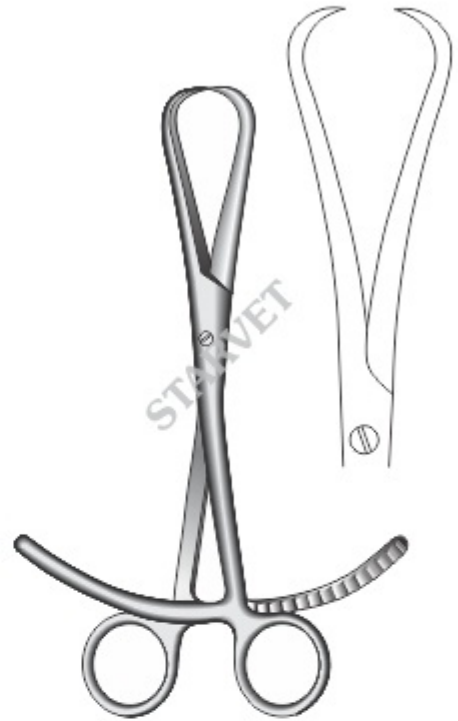

Bone Reduction Forceps  
ST03-2540 15 cm / 6"  
ST03-2541 18 cm / 7"  
ST03-2542 20 cm / 8"  
ST03-2543 30 cm / 12"



Bone Holding Forceps  
ST03-2550 14 cm / 5½"  
ST03-2551 9.5 cm / 3¾"  
ST03-2552 18 cm / 7"  
Small, Serrated



Bone Holding Forceps  
ST03-2560  
18 cm / 7"  
With Spin Lock  
Small, Serrated

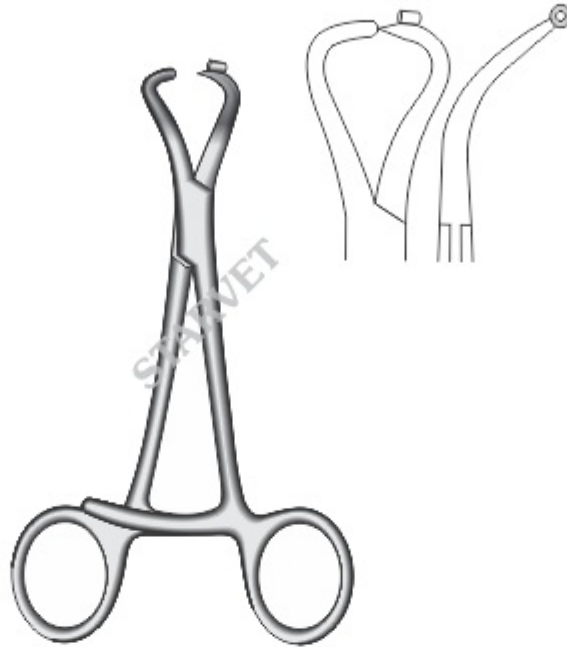

ST03-2570  
13 cm / 5¼"  
Bone holding forceps  
Curved, with 1.6 mm k-wire guide

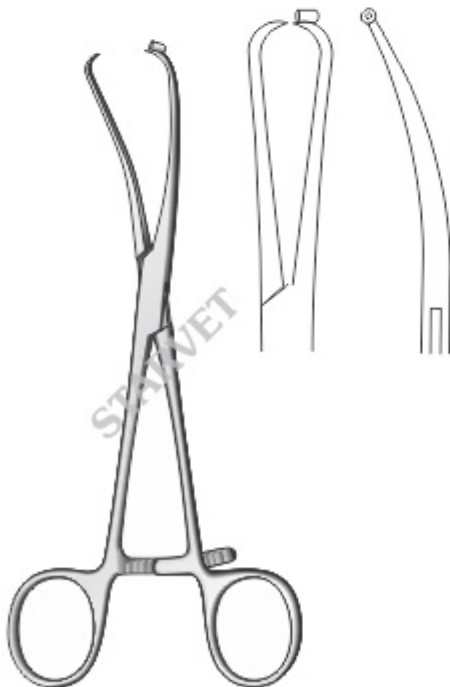

ST03-2580  
17 cm / 6¾"  
Bone holding forceps  
Curved, with 1.1 mm k-wire guide

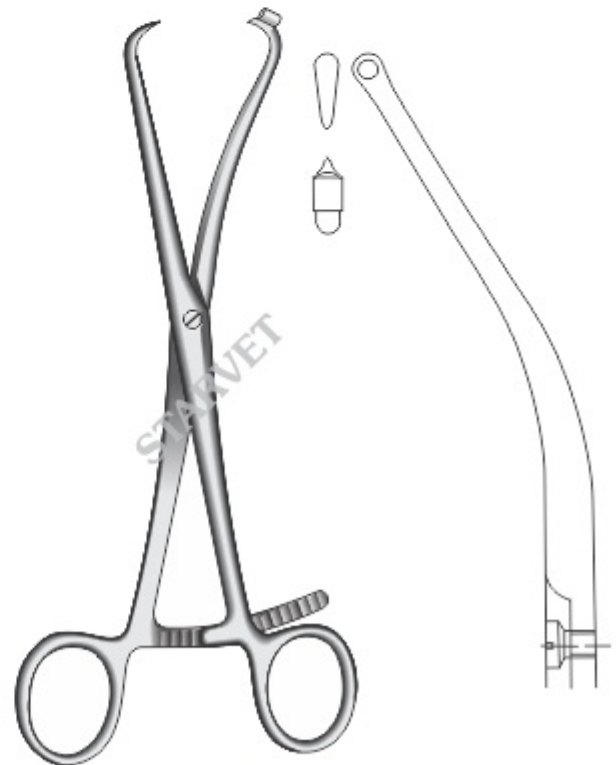

Meyer  
ST03-2590  
20.5 cm / 8"  
Reposition forceps  
with drill guide for kirschner  
wires up to diameter 2.0 mm



Bone Holding Forceps  
ST03-2600  
21.5 cm / 8½"  
with Spin Lock



Bone Holding Forceps  
ST03-2610  
21.5 cm / 8½"  
Twin Point With Spin Lock



Bone reduction forceps  
ST03-2620  
14 cm / 5¼"  
Small, curved  
Ratchet length = 1¼"



Bone Holding Forceps  
ST03-2630  
12 cm / 4¾"

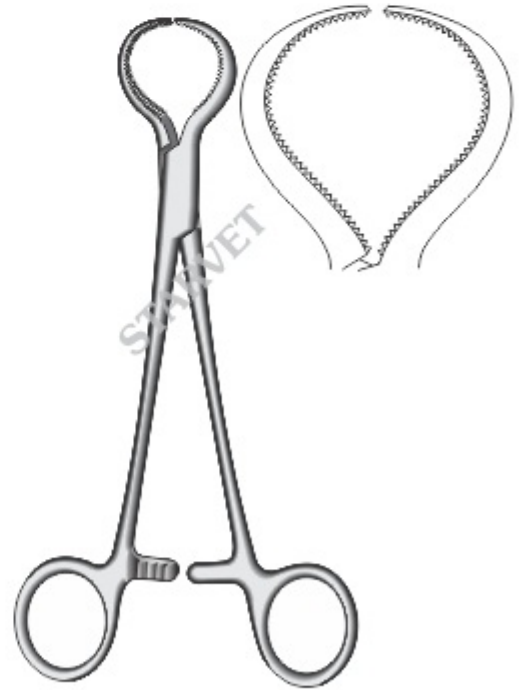

Lewin  
ST03-2640  
17.5 cm / 7"



Dingmann  
ST03-2650  
18.5 cm / 7¼"



Dingmann  
ST03-2660  
18.5 cm / 7¼"

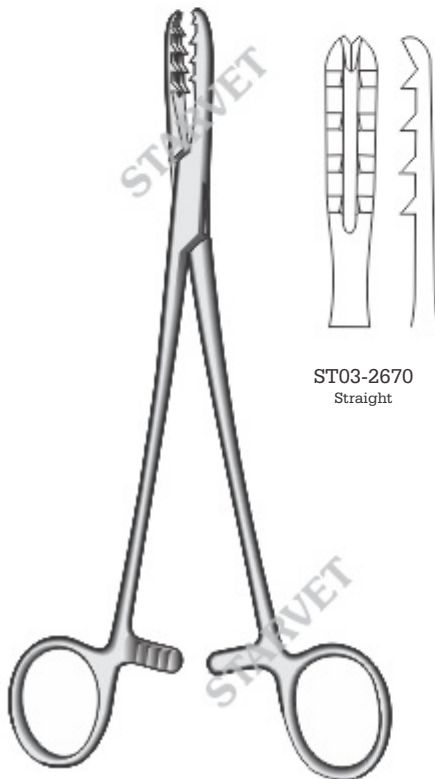

Bircher-Ganske  
20 cm / 8"

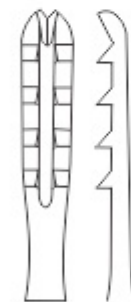

ST03-2670  
Straight



ST03-2671  
Curved

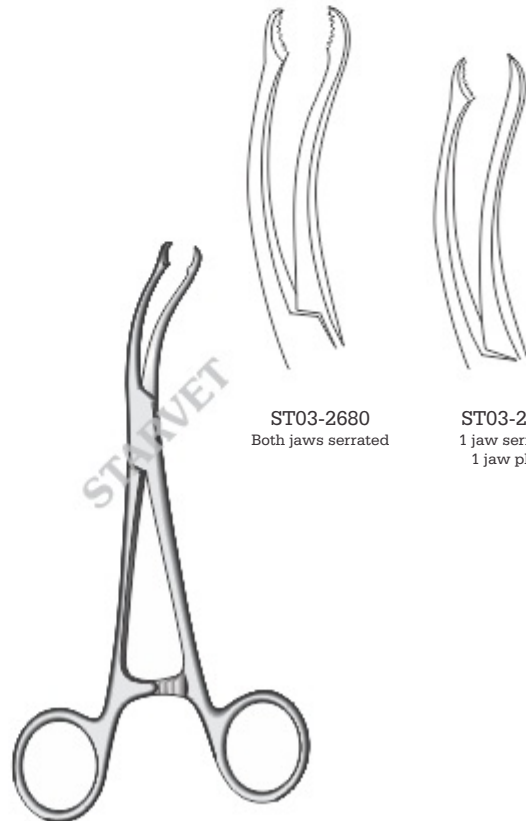

Verbrugge  
16 cm / 6¼"



ST03-2680  
Both jaws serrated



ST03-2681  
1 jaw serrated  
1 jaw plain

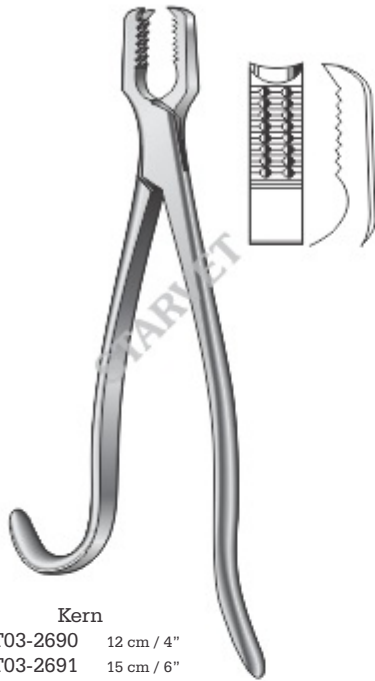

**Kern**  
ST03-2690 12 cm / 4"  
ST03-2691 15 cm / 6"  
ST03-2692 17 cm / 6½"  
ST03-2693 21 cm / 8¼"  
Without ratchet



**Kern**  
ST03-2700 12 cm / 4"  
ST03-2701 15 cm / 6"  
ST03-2702 17 cm / 6½"  
ST03-2703 21 cm / 8¼"  
ST03-2704 23 cm / 9"  
With ratchet



**Kern**  
ST03-2710 12 cm / 4"  
ST03-2711 15 cm / 6"  
ST03-2712 17 cm / 6½"  
ST03-2713 21 cm / 8¼"  
With Spin Lock



**Hey Groves**  
ST03-2720 21 cm / 8¼"  
ST03-2721 25 cm / 10"  
ST03-2722 27 cm / 10¾"  
ST03-2723 30.5 cm / 12"

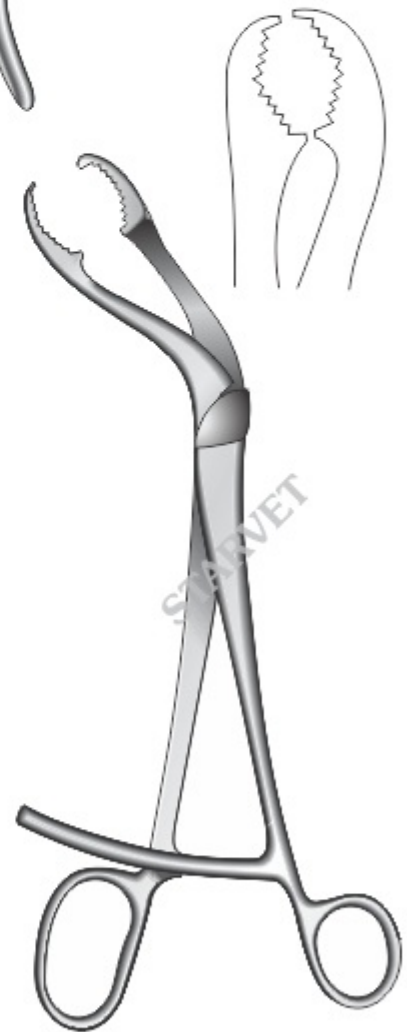

**Verbrugge Prehenseur**  
ST03-2730 18 cm / 7"  
ST03-2731 24 cm / 9½"  
ST03-2732 26 cm / 10¼"  
ST03-2733 28 cm / 11"  
Serrated jaws

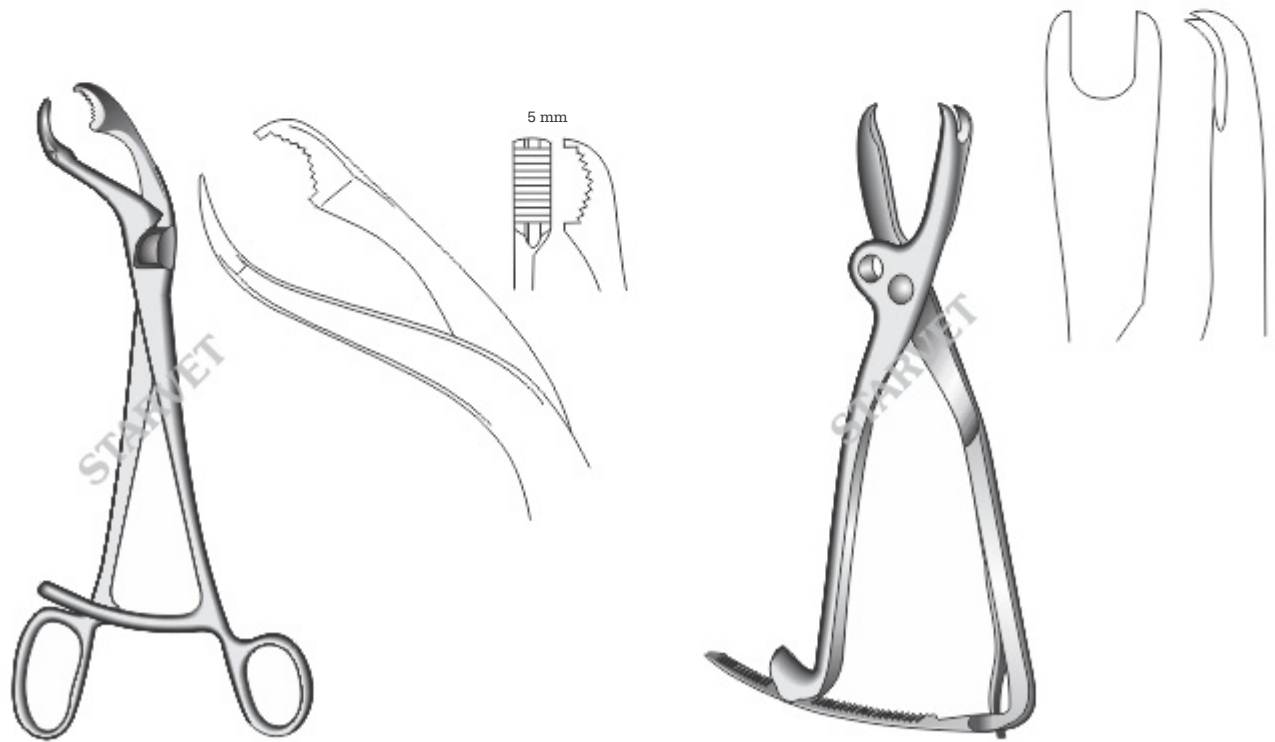
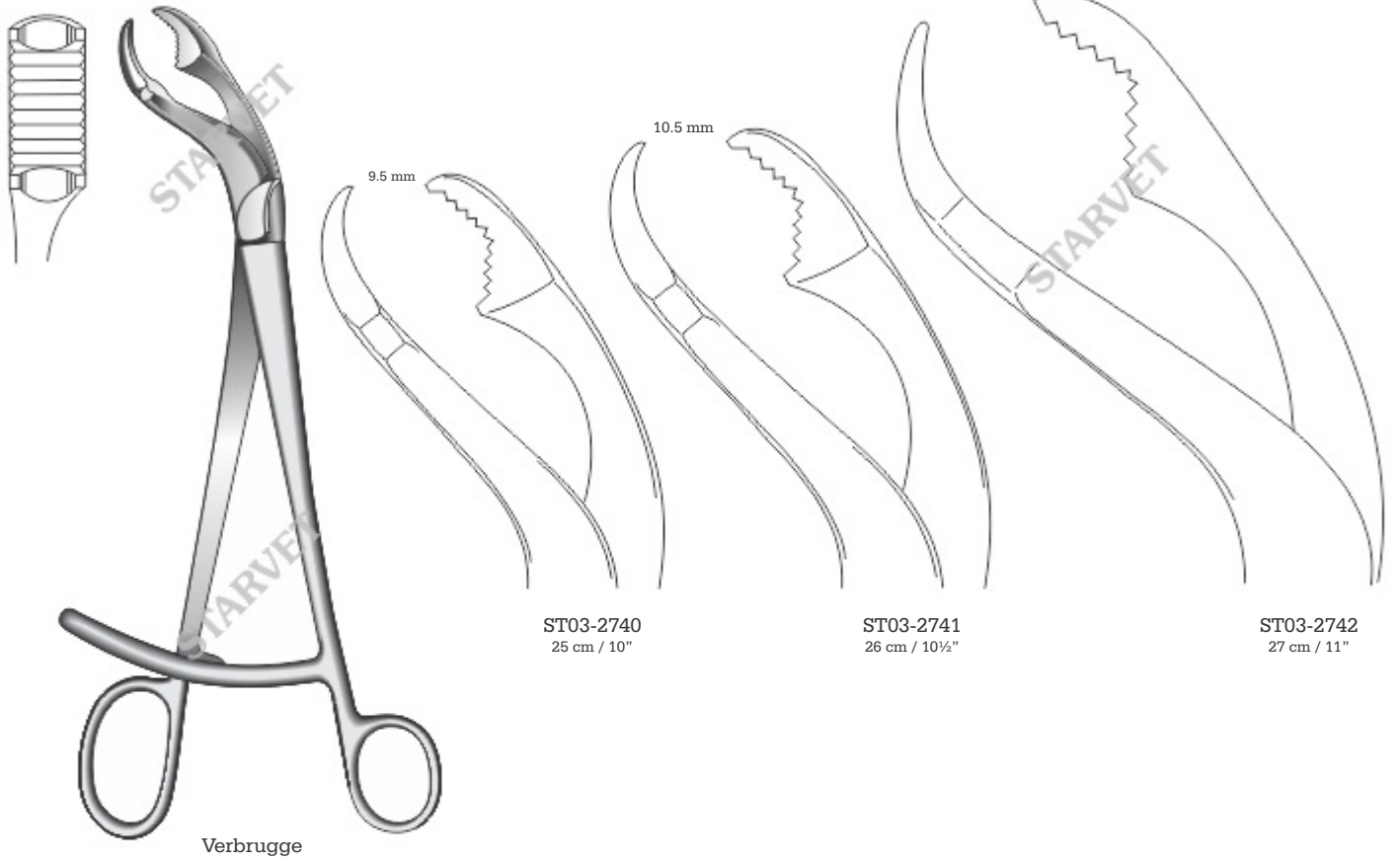

Verbrugge  
ST03-2750  
ST03-2751 Screw Joint  
17.5 cm / 6¾"



Bishop  
ST03-2760 23 cm / 9"  
ST03-2761 32.5 cm / 13"  
Adjustable jaws



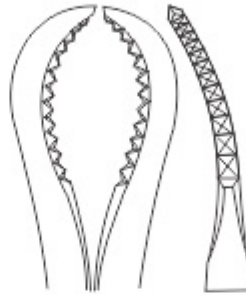

ST03-2770	16 cm / 6¼"
ST03-2771	18 cm / 7"
ST03-2772	19 cm / 7½"
ST03-2773	20 cm / 8"
ST03-2774	22 cm / 8½"
ST03-2775	24 cm / 9½"
ST03-2776	26 cm / 10¼"
ST03-2777	28 cm / 11"

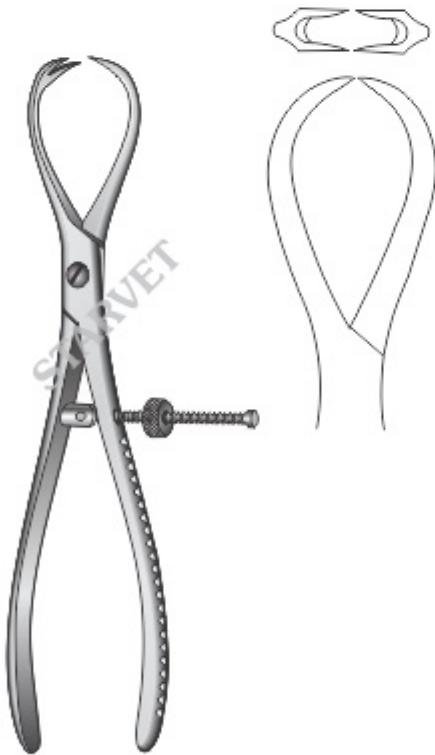

Patella Forceps  
ST03-2790  
18 cm / 7"  
2 x 2 sharp teeth  
with speed lock

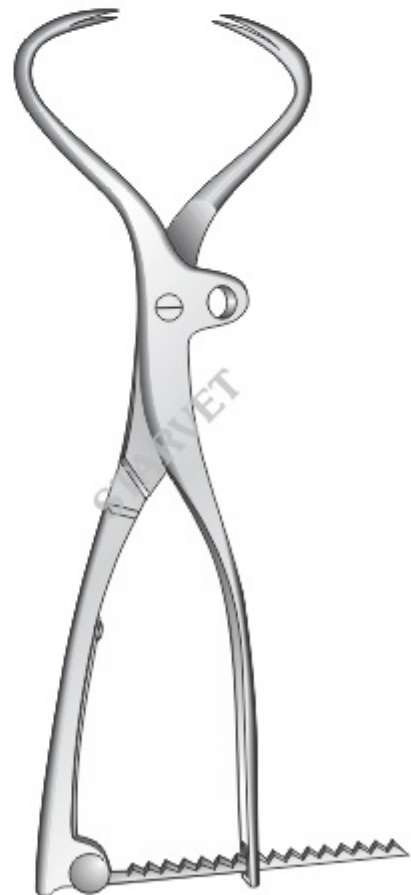

Ollier  
ST03-2800 19 cm / 7½"  
ST03-2801 22 cm / 8½"  
ST03-2802 27 cm / 10¾"

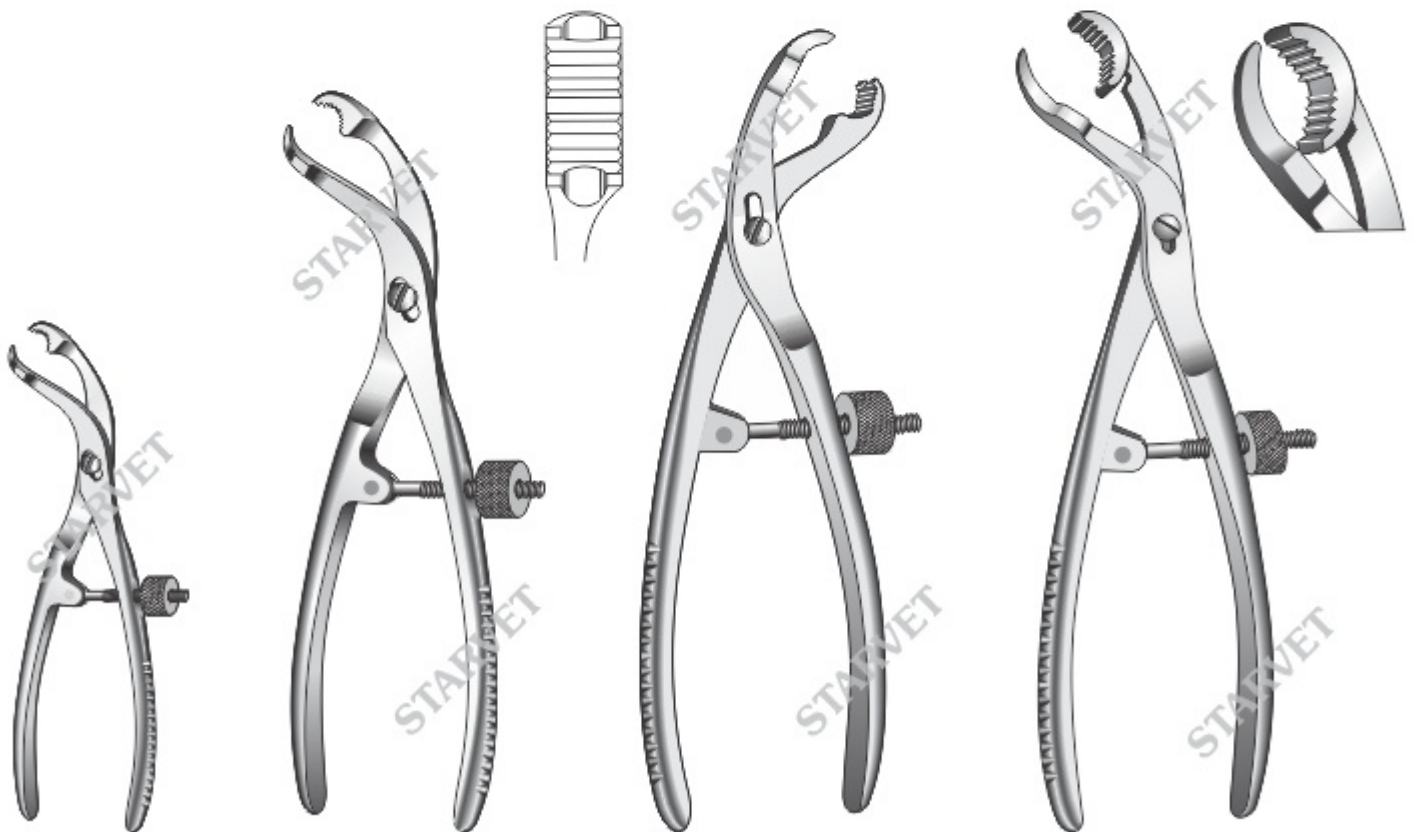
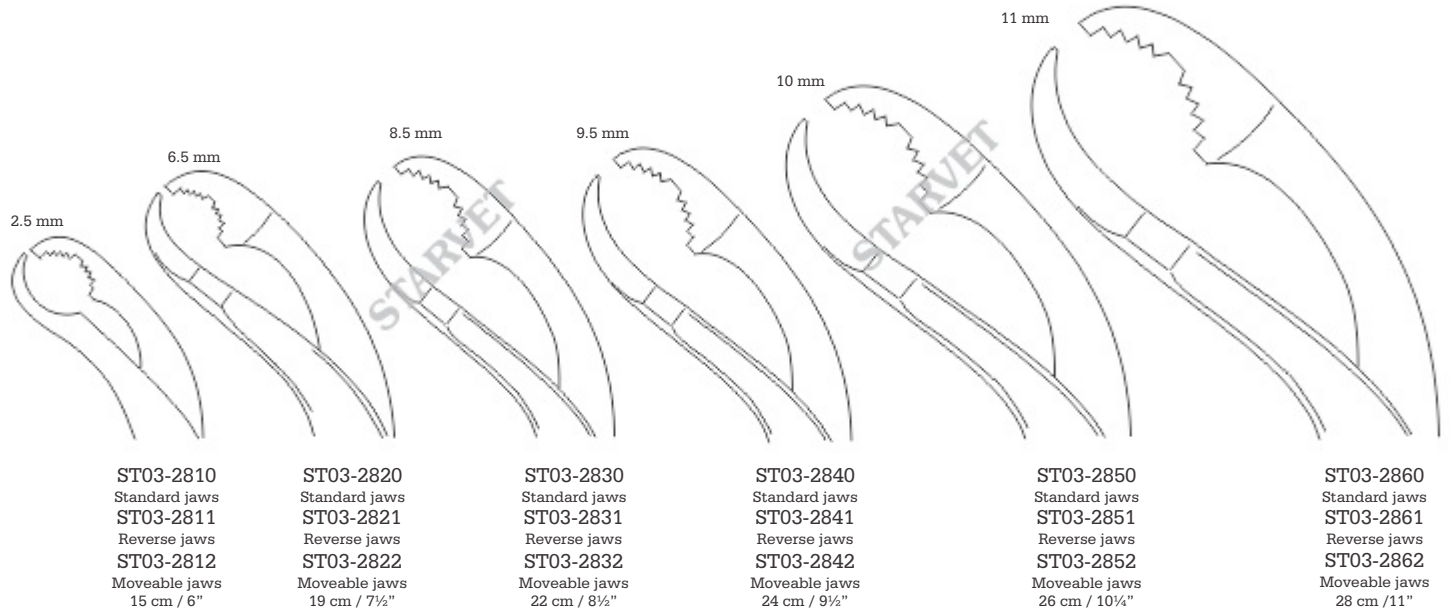

Mini  
ST03-2870  
12 cm / 4¾"  
Special size

Self-Centering Forceps  
Standard jaws

Self-Centering Forceps  
With thread fixation  
Reverse jaws

Verbrugge  
With moveable jaws

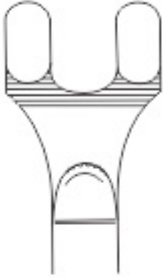

ST03-2880  
6 cm / 2½"  
Special mini

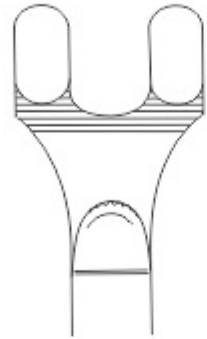

ST03-2881  
8.5 cm / 3¼"  
Special mini

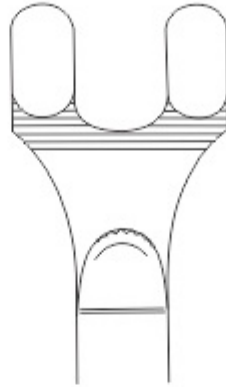

ST03-2882  
12 cm / 4¾"

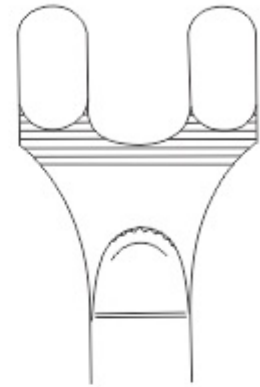

ST03-2883  
18 cm / 7"

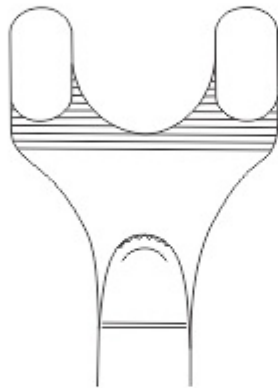

ST03-2884  
20 cm / 8"

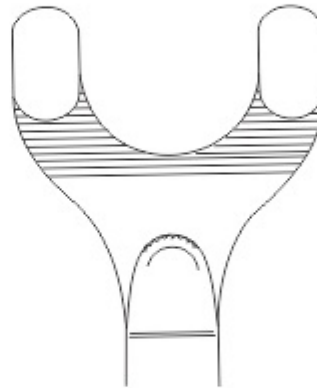

ST03-2885  
22 cm / 8¾"

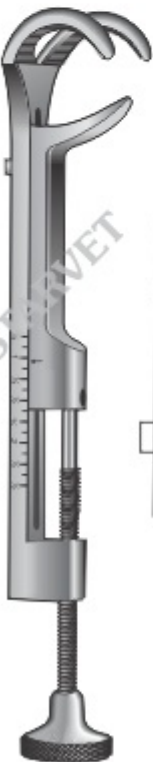

Gerster - Lowmann  
1 x 2 jaws

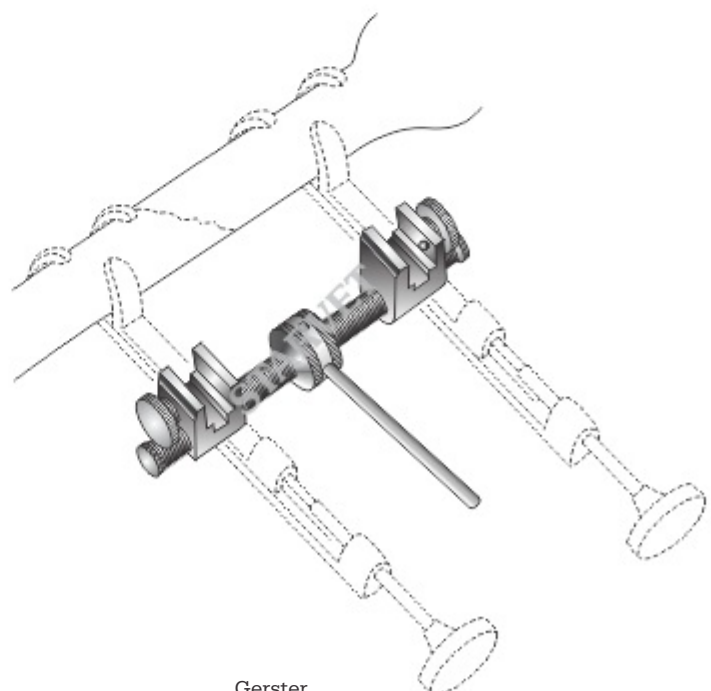
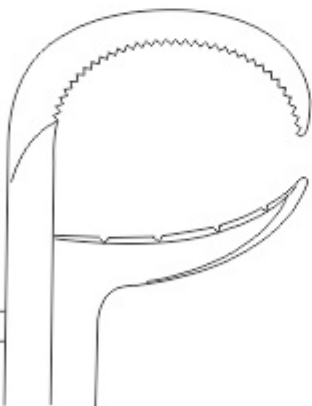

Gerster  
ST03-2890



**Micro Friedman**  
15 cm / 6"  
2 x 6 mm bite  
Delicate



**ST03-2900**  
Straight



**ST03-2901**  
Curved  
2.2 mm



**ST03-2902**  
Curved  
3 mm



**ST03-2910**  
14 cm / 5 1/2"  
Side Curved



**ST03-2911**  
1.5 x 5 mm bite  
Straight



**ST03-2912**  
1.5 x 5 mm bite  
Angled 30°



**ST03-2913**  
1.5 x 5 mm bite  
Angled 90°



**Micro-Friedman**  
14 cm / 5 1/2"  
Extremely delicate  
For soft tissue and cancellous bone only



**Cleveland**  
**ST03-2920**  
17 cm / 6 3/4"

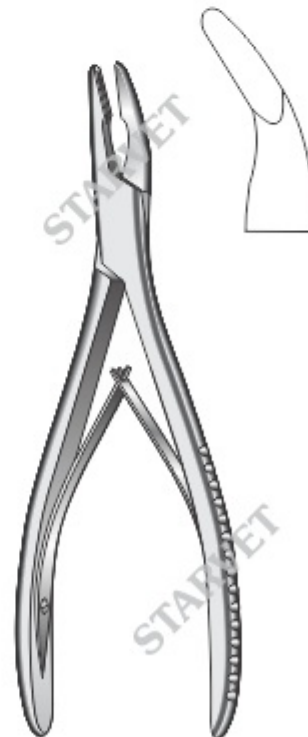

**Hartmann**  
**ST03-2930**  
18.5 cm / 7 1/4"

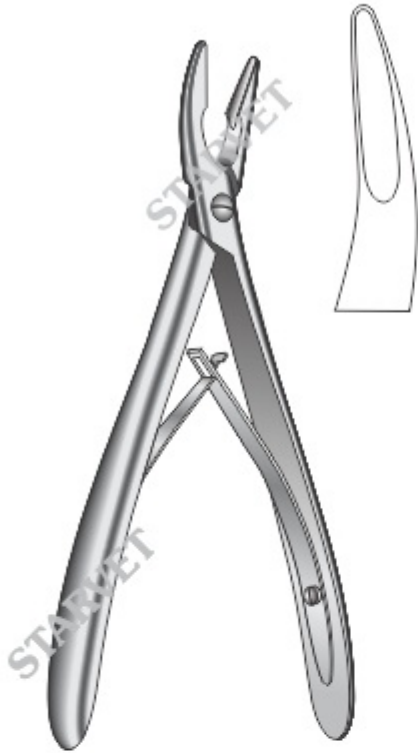

ST03-2940  
Small Curved Rongeur



Daniel Rongeurs  
ST03-2950  
13 cm / 5"  
2 mm bite  
Bite 130 mm



Duck-Billed Daniel Rongeurs  
ST03-2960  
17.7 cm / 7"  
3 mm bite  
Side Curved

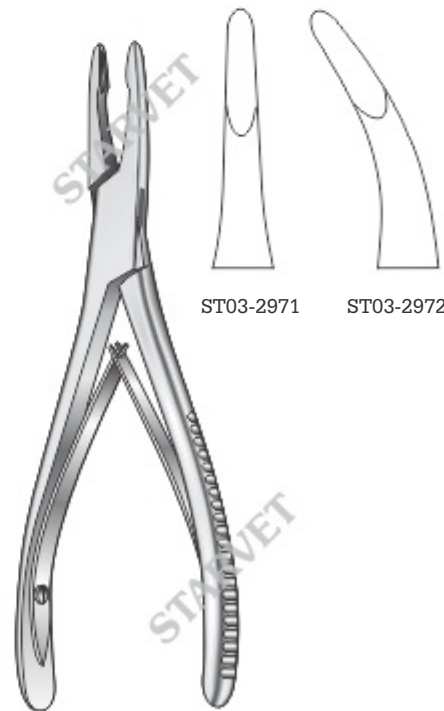

Jansen  
ST03-2970  
18 cm / 7"

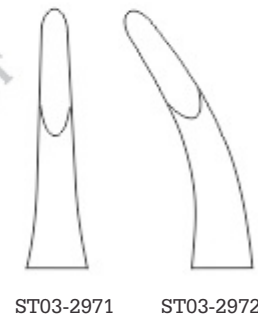

ST03-2971      ST03-2972



**Lempert**  
2.5 mm bite



**ST03-2980**  
16 cm / 6¼"  
**ST03-2982**  
19 cm / 7½"  
Straight



**ST03-2981**  
16 cm / 6¼"  
**ST03-2983**  
19 cm / 7½"  
Curved



**ST03-2990**  
16 cm / 6¼"  
**ST03-2992**  
18.5 cm / 7¼"  
Straight



**ST03-2991**  
16 cm / 6¼"  
**ST03-2993**  
18.5 cm / 7¼"  
Curved

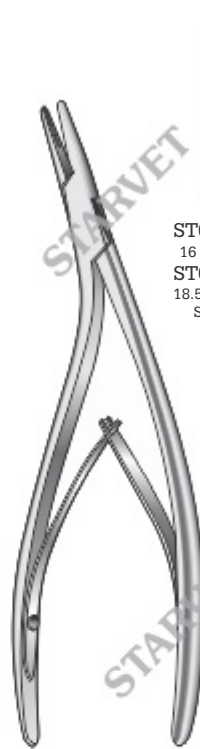

**Juers-Lempert**  
Straight jaws on curved  
handles, delicate, 2.5 mm bite



**ST03-3000**  
Slightly curved



**ST03-3001**  
Curved



**ST03-3002**  
Angled at 90



**Blumenthal**  
15 cm / 6"



**ST03-3010**  
Slightly curved



**ST03-3011**  
Curved



**ST03-3012**  
Extra curved



**Luer**  
15 cm / 6"

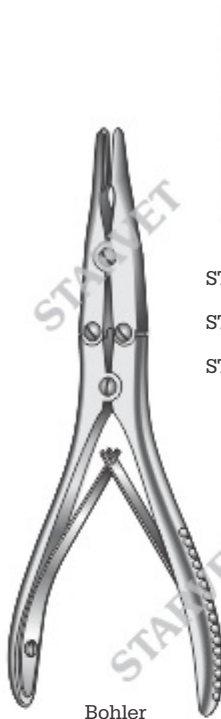

**Bohler**  
15 cm / 6"



ST03-3020  
2 mm tip  
ST03-3022  
3 mm tip  
ST03-3024  
4 mm tip



ST03-3021  
2 mm tip  
ST03-3023  
3 mm tip  
ST03-3025  
4 mm tip



**Zaufal-Jansen**  
ST03-3030 Straight  
ST03-3031 Curved  
18 cm / 7"



**Mayfield**  
ST03-3040  
17 cm / 6 1/2"



**Ruskin**  
Delicate



ST03-3050  
ST03-3052  
ST03-3054  
15 cm / 6"

ST03-3060  
ST03-3062  
ST03-3064  
ST03-3066  
ST03-3068  
17.5 cm / 7"

ST03-3080  
ST03-3082  
ST03-3084  
ST03-3086  
ST03-3088  
20 cm / 8"  
Straight



2 mm  
3 mm  
4 mm  
15 cm / 6"

2 mm  
3 mm  
4 mm  
6 mm  
8 mm  
17.5 cm / 7"

2 mm  
3 mm  
4 mm  
6 mm  
8 mm  
20 cm / 8"  
Curved

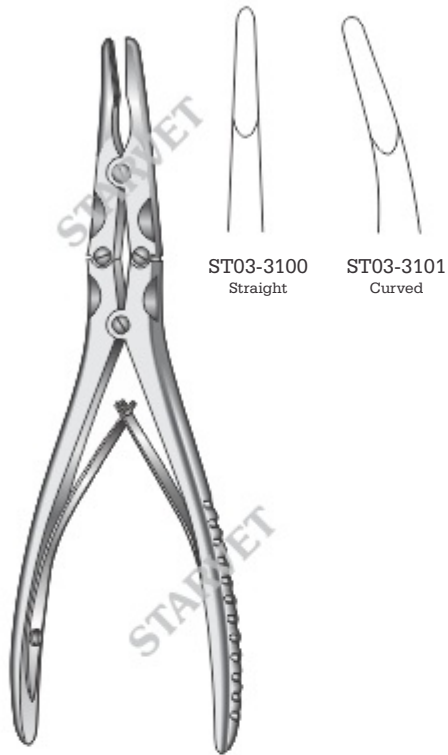

Beyer  
18 cm / 7"



Ruskin  
ST03-3110  
23 cm / 9"

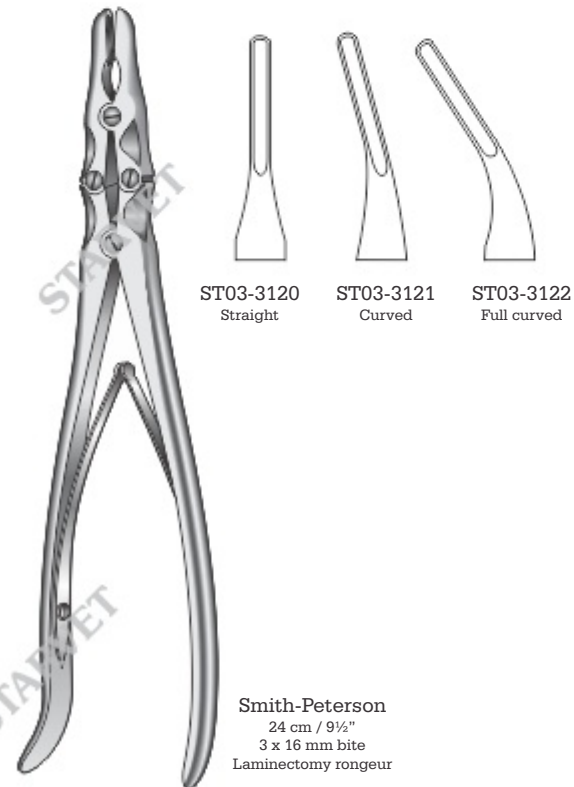

Smith-Peterson  
24 cm / 9½"  
3 x 16 mm bite  
Laminectomy rongeur



Marquard  
ST03-3130  
20 cm / 8"





Stille-Luer  
22 cm / 8½"  
8 mm



ST03-3140  
ST03-3142  
ST03-3144  
ST03-3146  
ST03-3148

4 mm  
6 mm  
8 mm  
10 mm  
12 mm



ST03-3141  
ST03-3143  
ST03-3145  
ST03-3147  
ST03-3149



Stille-Luer  
ST03-3160

Stille-Luer Heavy Compound Action 8 mm curved  
A very large rongeur with 8 mm bite. Can be used to aggressively remove pieces of tooth. Also useful for removal of heavy plaque on teeth.

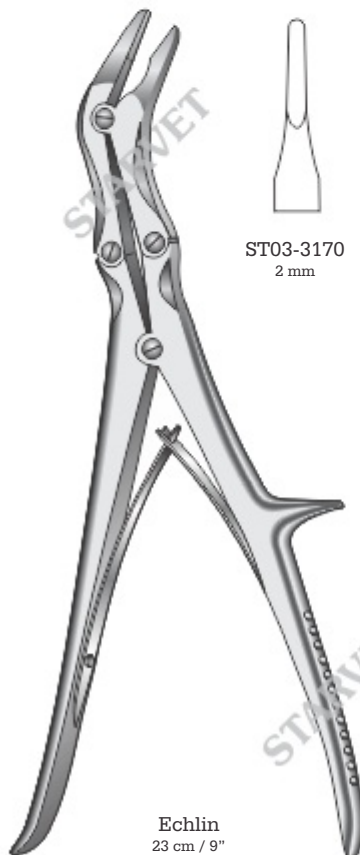

Echlin  
23 cm / 9"



ST03-3170  
2 mm



ST03-3171  
3 mm



ST03-3172  
4 mm



Stille  
ST03-3180  
23 cm / 9"

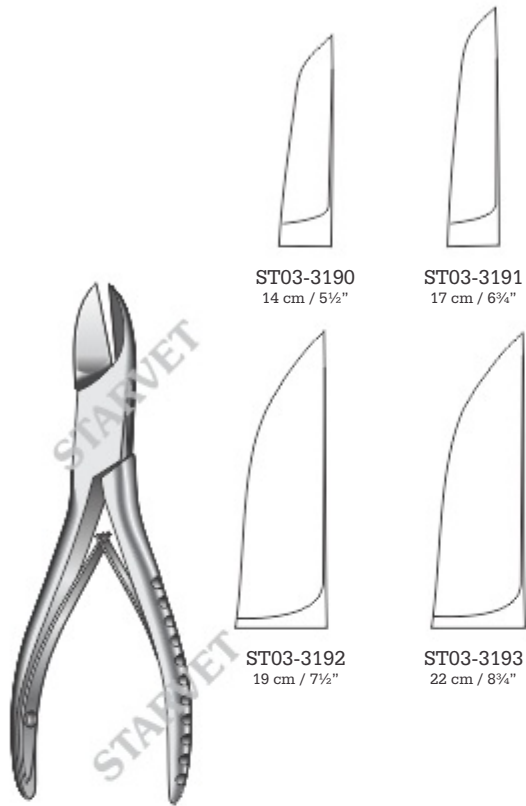

ST03-3190  
14 cm / 5½"

ST03-3191  
17 cm / 6"

ST03-3192  
19 cm / 7½"

ST03-3193  
22 cm / 8¾"

Liston

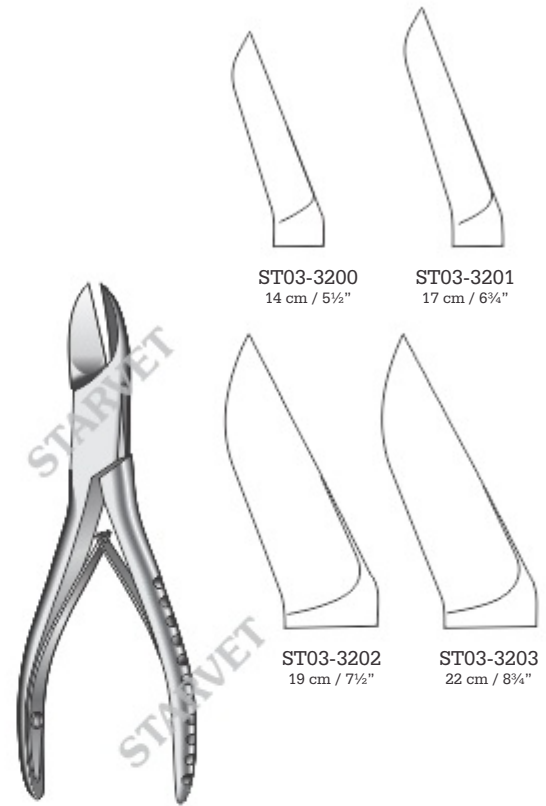

ST03-3200  
14 cm / 5½"

ST03-3201  
17 cm / 6"

ST03-3202  
19 cm / 7½"

ST03-3203  
22 cm / 8¾"

Liston



Cleveland  
ST03-3210 17 cm / 6¾"  
ST03-3211 23 cm / 9"



Stamm  
ST03-3220  
15 cm / 6"

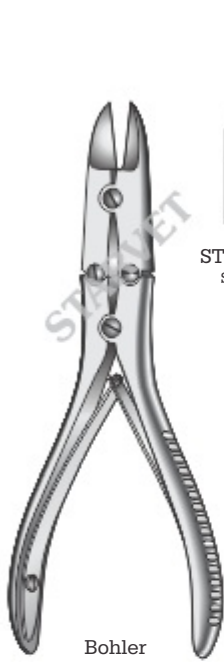

**Bohler**  
14.5 cm / 5 3/4"



ST03-3230  
Straight

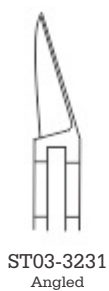

ST03-3231  
Angled



**Mc Indoe**  
ST03-3240 17.5 cm / 7"  
ST03-3241 19 cm / 7 1/2"



**Ruskin-Liston**  
18.5 cm / 7 1/4"



ST03-3250  
Straight



ST03-3251  
Angled

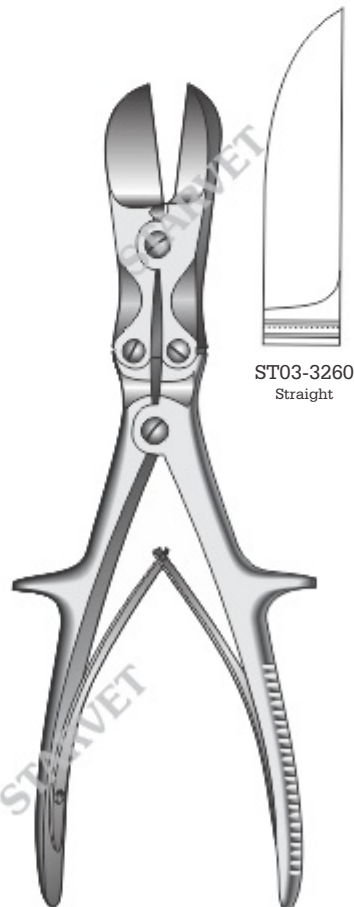
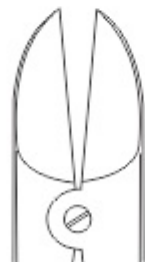

**Stille-Liston**  
27 cm / 10 1/2"



ST03-3260  
Straight



ST03-3261  
Angled



Stille  
ST03-3270  
21 cm / 8¼"

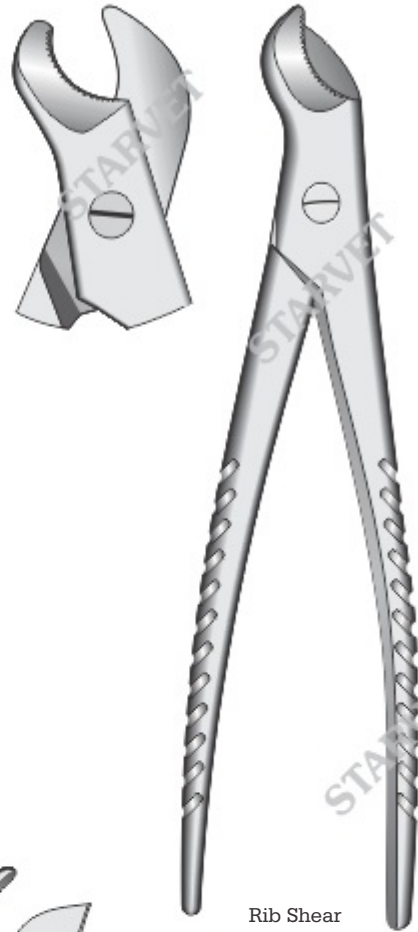

Rib Shear  
ST03-3280



ST03-3290 20 cm / 8"  
ST03-3291 23 cm / 9"



ST03-3300  
22 cm / 8¾"



ST03-3310  
15.5 cm / 6"



Corwin  
ST03-3320  
16 cm / 6¼"



ST03-3330  
15 cm / 6"



ST03-3340  
20 cm / 8"



ST03-3350 18.5 cm / 7¼"  
ST03-3351 20 cm / 8"  
Heavy duty needle driver



ST03-3360  
Jet wire twister



ST03-3370  
'K' Wire / 'A' Wire Remover  
14 cm / 5½"  
TC



ST03-3380  
15 cm / 6"  
For bending & cutting



ST03-3390 Standard  
ST03-3391 TC  
Wire twister / Shear cutter  
cuts wire up to 18g, twisted double



ST03-3400

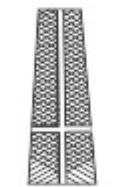

ST03-3401  
With crosswise  
groove



Hakstick  
ST03-3410  
16 cm / 6¼"  
With longitudinal groove



Plier  
ST03-3420  
14 cm / 5½"



**ST03-3430**  
Wire Contouring Pliers  
15 cm / 6"

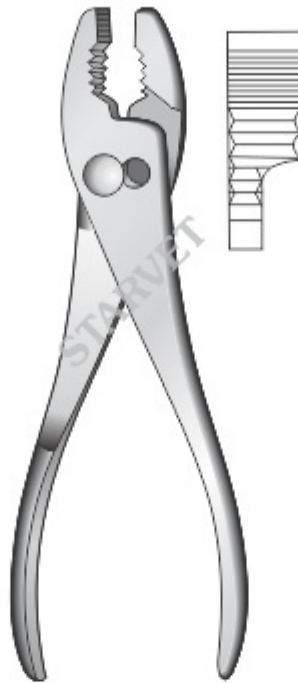

**ST03-3440**  
20 cm / 8"  
Slip joint plier  
10 mm tip  
Maximum opening 2"



Plier  
**ST03-3450** 13 cm / 5¼"  
**ST03-3451** 17 cm / 6½"



Plier  
**ST03-3460** 17 cm / 6½"  
**ST03-3461** 12.5 cm / 5"  
With side cutter



Plier  
**ST03-3470** 17 cm / 6½"  
**ST03-3471** 12.5 cm / 5"  
With side cutter, TC

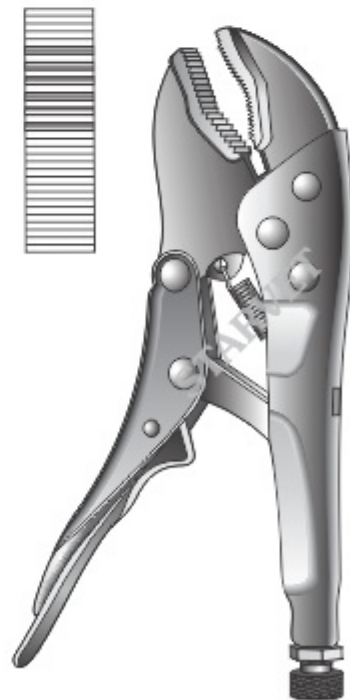

Plier  
**ST03-3480**  
18 cm / 7"

**Heavy Duty Locking Pliers & Needle Nose Locking Pliers**  
with a new reinforced, more durable jaw.

- Heavy duty jaws lock securely onto pins.
- Reinforced jaw hinge and housing are more rigid to
- Help prevent side to side shifting.
- Made from 300 and 400 series Surgical grade
- Stainless steel.
- Will not chip or contaminate other instrumentation
- Adjustment screw for easy control of jaw opening
- One handed, quick release self-locking lever.
- Available in three sizes.

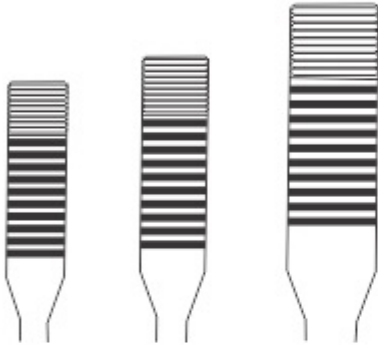

<b>ST03-3490</b> 17.5 cm / 6¾" Tip width 7 mm Max. Opening 1" Small	<b>ST03-3491</b> 20 cm / 8" Tip width 9 mm Max. Opening 1" Medium	<b>ST03-3492</b> 25.5 cm / 10" Tip width 13 mm Max. Opening 1" Large
---	---	--



**ST03-3500**  
17 cm / 6¾"



**ST03-3501**  
24 cm / 9½"  
Length of jaw 2½"  
Tip width 5 mm  
Jaws are parallel  
at 3 mm



**ST03-3502**  
30 cm / 12"  
Length of jaw 3"  
Tip width 7 mm  
Jaws are parallel  
at 5 mm  
Large



Locking plier



Plier  
ST03-3485



Needle nose locking plier



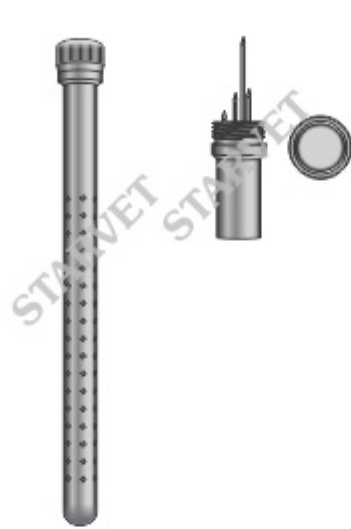

Wire Dispenser

mm	0.8	0.9	1.0	1.1	1.4	1.5	1.6	1.8	2.0
150	ST03-3510	ST03-3511	ST03-3512	ST03-3513	ST03-3514	ST03-3515	ST03-3516	ST03-3517	ST03-3518
165	ST03-3530	ST03-3531	ST03-3532	ST03-3533	ST03-3534	ST03-3535	ST03-3536	ST03-3537	ST03-3538
180	ST03-3550	ST03-3551	ST03-3552	ST03-3553	ST03-3554	ST03-3555	ST03-3556	ST03-3557	ST03-3558
225	ST03-3570	ST03-3571	ST03-3572	ST03-3573	ST03-3574	ST03-3575	ST03-3576	ST03-3577	ST03-3578
320	ST03-3590	ST03-3591	ST03-3592	ST03-3593	ST03-3594	ST03-3595	ST03-3596	ST03-3597	ST03-3598

Wire Dispenser

ST03-3610	0.9/1.1/1.6/2.0, 175 mm
ST03-3611	0.9/1.1/1.25/1.4, 175 mm
ST03-3612	1.5/1.6/1.8/2.0, 175 mm



Wire Dispenser

mm	0.8	0.9	1.0	1.1	1.4	1.5	1.6	1.8	2.0
150	ST03-3620	ST03-3621	ST03-3622	ST03-3623	ST03-3624	ST03-3625	ST03-3626	ST03-3627	ST03-3628
165	ST03-3640	ST03-3641	ST03-3642	ST03-3643	ST03-3644	ST03-3645	ST03-3646	ST03-3647	ST03-3648
180	ST03-3660	ST03-3661	ST03-3662	ST03-3663	ST03-3664	ST03-3665	ST03-3666	ST03-3667	ST03-3668
225	ST03-3680	ST03-3681	ST03-3682	ST03-3683	ST03-3684	ST03-3685	ST03-3686	ST03-3687	ST03-3688
320	ST03-3700	ST03-3701	ST03-3702	ST03-3703	ST03-3704	ST03-3705	ST03-3706	ST03-3707	ST03-3708

Pin Punch

ST03-3730	1.6mm
ST03-3731	3.5mm
ST03-3732	6.0mm
	13.5 cm / 5 1/4"

Wire Bender  
ST03-3720  
14 cm / 5 1/2"



**Diamant**  
**ST03-3740**  
16 cm / 6¼"



**ST03-3750**  
16 cm / 6¼"  
for soft wires up to 2.5 mm Ø  
for hard wires up to 2.0 mm Ø



**ST03-3760**  
16 cm / 6¼"  
for soft wires up to 2.4 mm Ø  
for hard wires up to 1.8 mm Ø



**ST03-3770** 16 cm / 6¼"  
**ST03-3771** 18 cm / 7"  
**ST03-3772** 20 cm / 8"  
**ST03-3773** 21.5 cm / 8½"  
**ST03-3774** 25 cm / 9¼"  
TC



**ST03-3780** 14 cm / 5½"  
**ST03-3781** 16 cm / 6¼"  
**ST03-3782** 18 cm / 7"  
TC

For up to  
1.6 mm



**ST03-3790**  
22 cm / 8¾"  
For soft wires up to 2.6 mm Ø  
For hard wires up to 2.2 mm Ø  
TC

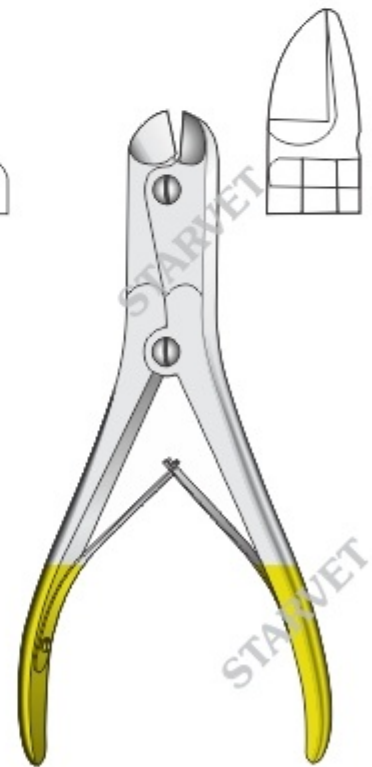

**ST03-3800** 14 cm / 5½"  
**ST03-3801** 16 cm / 6¼"  
**ST03-3802** 18 cm / 7"  
**ST03-3803** 22 cm / 8¾"  
For soft wires up to 3 mm Ø  
For hard wires up to 2.2 mm Ø  
TC



**ST03-3810**  
15 cm / 6"  
For soft wires up to 2.0 mm  $\emptyset$   
For hard wires up to 1.2 mm  $\emptyset$



**ST03-3820**  
22 cm / 8 3/4"  
For soft wire up to 3.5 mm  $\emptyset$   
For hard wire up to 2.5 mm  $\emptyset$

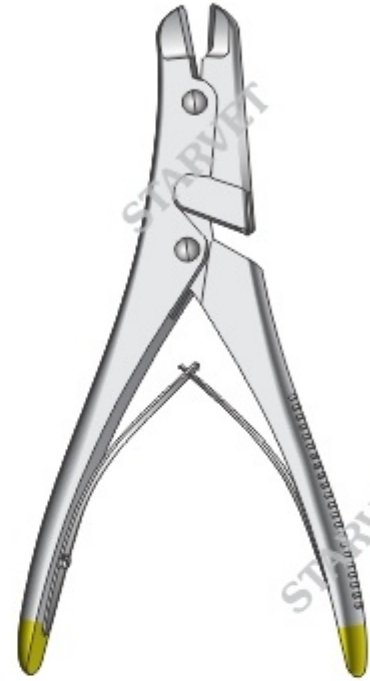

**ST03-3830**  
22 cm / 8 3/4"  
For soft wires up to 2.6 mm  $\emptyset$   
For hard wires up to 2.2 mm  $\emptyset$   
TC



For soft wires



For hard wires



**ST03-3840**  
18 cm / 7"  
For soft wires up to 2 mm  $\emptyset$   
For hard wires up to 1.5 mm  $\emptyset$



**ST03-3850**  
32 cm / 12 3/4"  
For soft wire up to 3.0 mm  $\emptyset$   
For hard wire up to 3.0 mm  $\emptyset$

Cutter for cutting off  
kirschner wires, tibia head  
screws, bolts & pins  
up to 3 mm



**ST03-3860**  
32 cm / 12 3/4"  
Cut three wires at once  
For soft wire up to 4.0 mm  $\emptyset$   
For hard wire up to 3.0 mm  $\emptyset$



ST03-3870  
25 cm / 10"  
For wires up to 3.0 mm  
Head cutter

ST03-3880  
38 cm / 15"  
For wires up to 4.0 mm  
Head cutter

Wire Cutter  
ST03-3890 38.5 cm / 15", For 5 mm wires  
ST03-3891 45 cm / 17 3/4", For 6 mm wires  
ST03-3892 56 cm / 22", For 7.5 mm wires  
TC

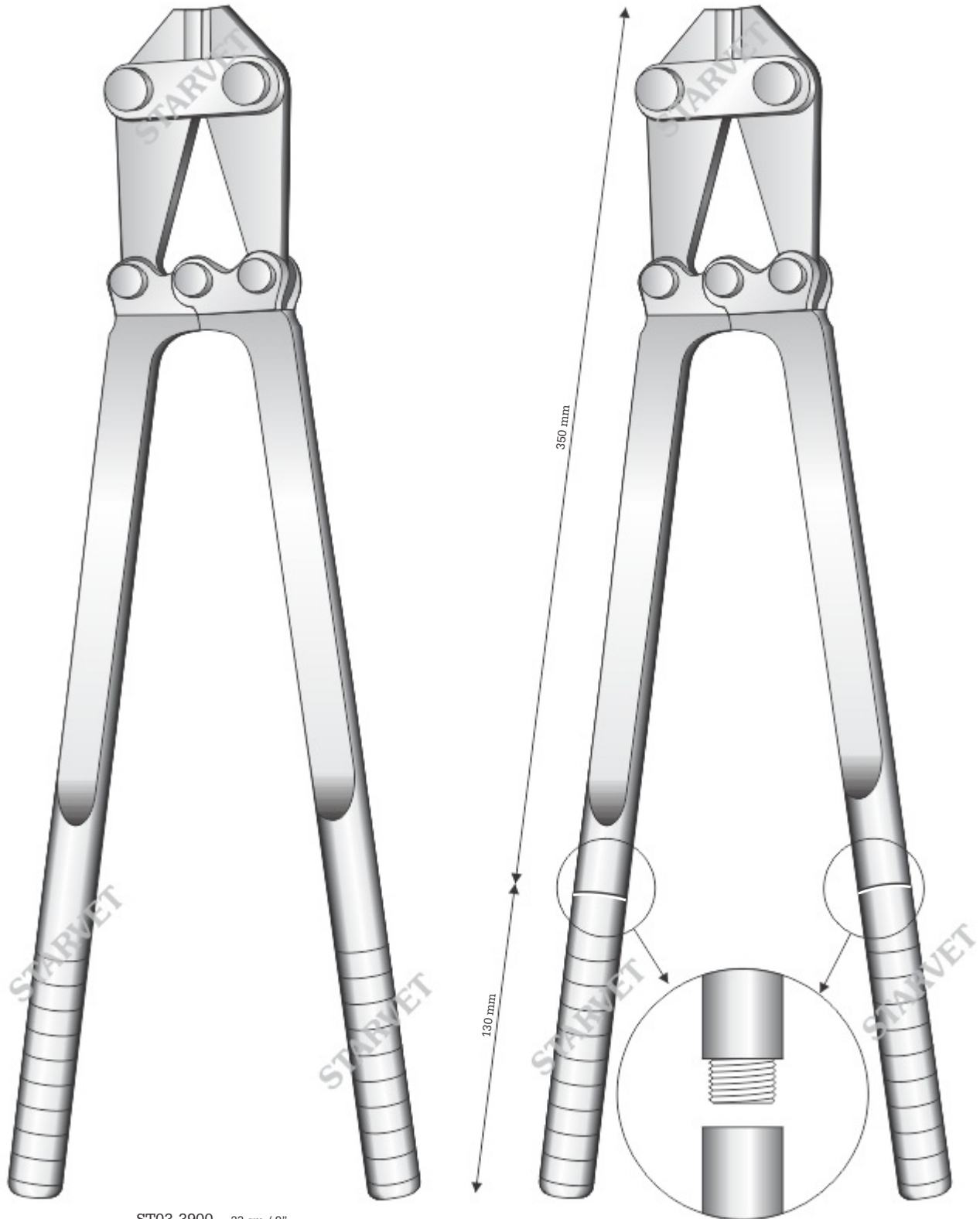

- ST03-3900 23 cm / 9"
- ST03-3901 30 cm / 12"
- ST03-3902 47 cm / 18½"
- ST03-3903 56 cm / 22"

Cutter for cutting off kirschner wires,  
tibia head screws  
bolts, pins up to 6 mm

- ST03-3910  
48 cm / 19"

Cutter for cutting off wires,  
head screws  
and pins up to 6 mm

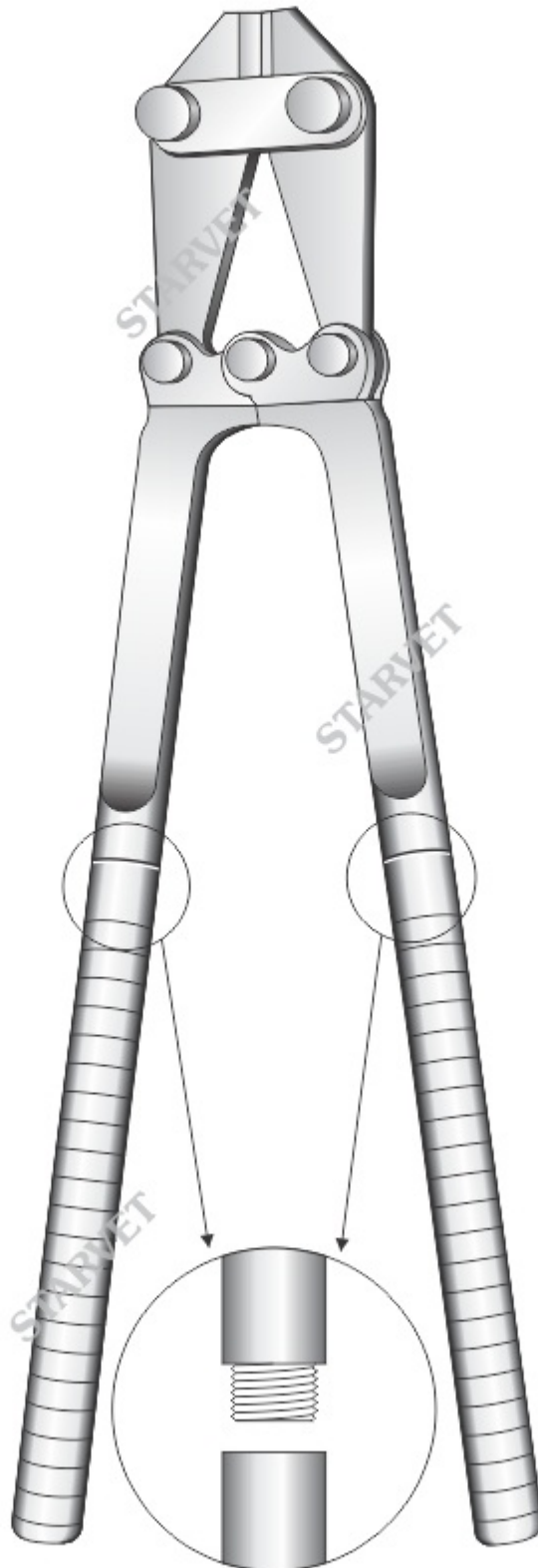

ST03-3920  
47 cm / 18½"  
Cutter for cutting off wires,  
head screws  
and pins up to 6 mm

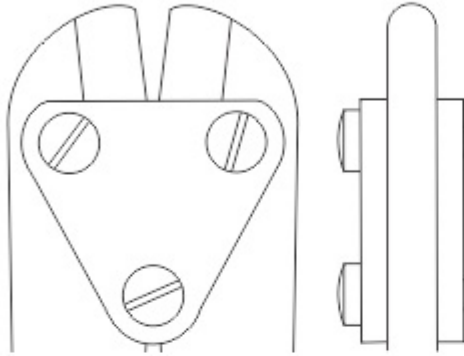

**ST03-3930**  
24 cm / 9½"  
Plate cutting forceps  
For cutting stainless steel  
mini plates up to 1 mm



**ST03-3940**  
38 cm / 15"  
Double action pin cutter  
Heavy duty with Carb-N-Sert cutting blades  
Cuts upto 3/16"Ø  
Stainless steel

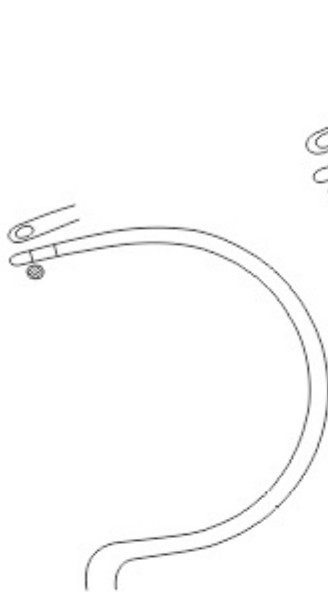

ST03-3950  
27.5 cm / 10¾"  
Fig. 3

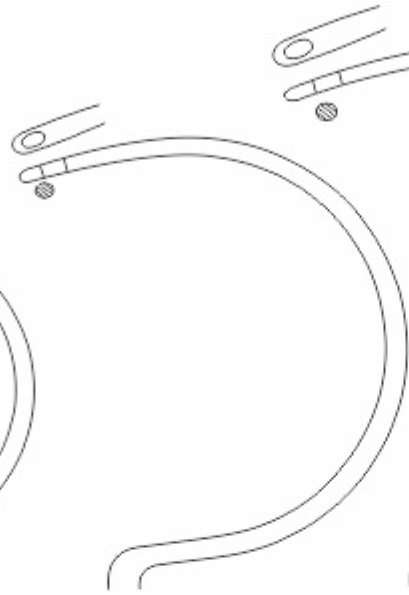

ST03-3951  
28.5 cm / 11¼"  
Fig. 2

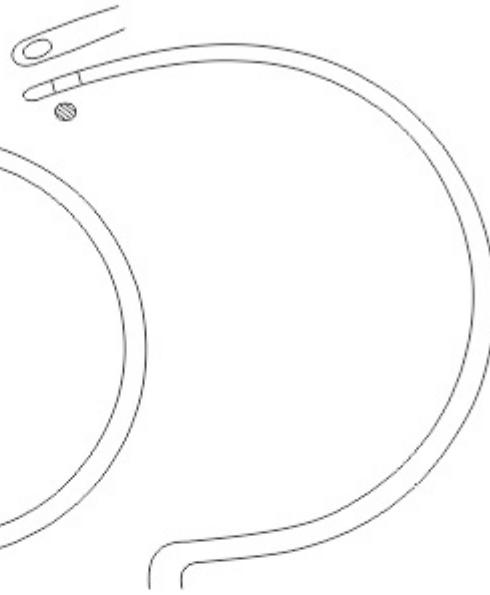

ST03-3952  
30.5 cm / 12"  
Fig. 1



Demel  
Wire guides

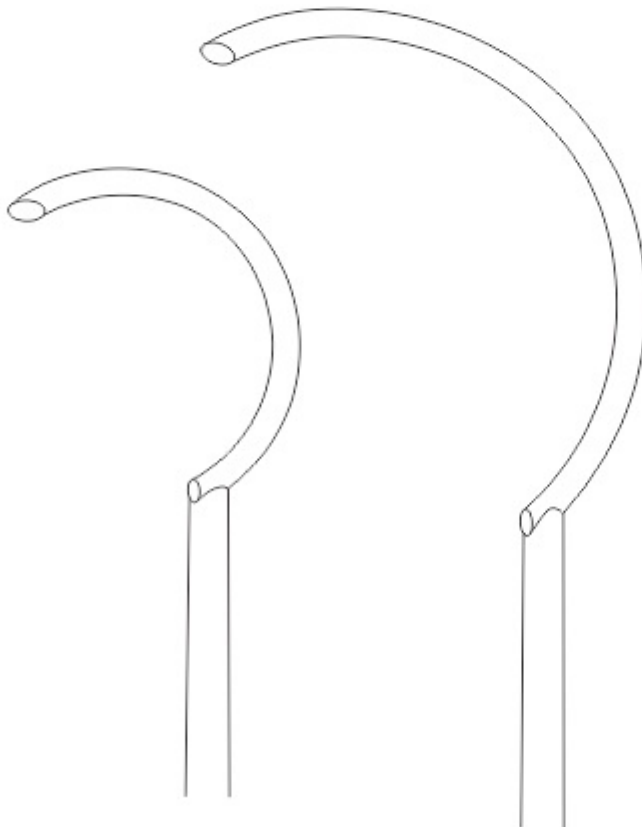

ST03-3960 20.5 cm / 8", 20 mm Ø  
ST03-3961 22 cm / 8½", 30 mm Ø  
ST03-3962 25 cm / 10", 40 mm Ø  
Wire Passer Single-Ended





Wire Passer  
ST03-3970  
Double Ended

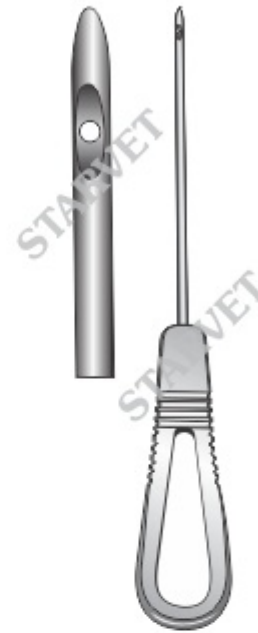

Graft Passer  
ST03-3980  
Straight

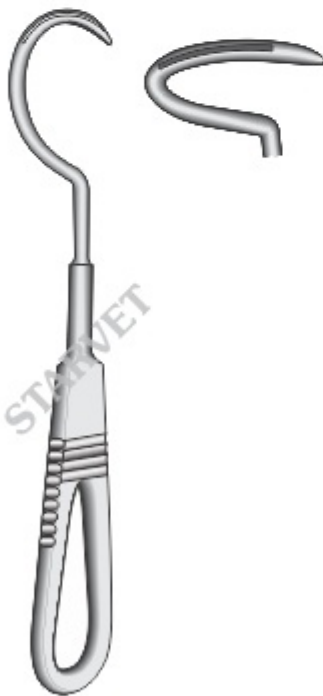

Graft Passer  
ST03-3990 Very Small, 2 cm, 165 mm  
ST03-3991 Small, 3 cm, 175 mm  
ST03-3992 Large, 4.5 cm, 185 mm  
ST03-3993 Very Large, 6 cm, 205 mm  
ST03-3994 Extra Large, 8 cm, 220 mm  
Curved



Graft Passer  
ST03-4000 Very small, 2 cm, 165 mm  
ST03-4001 Small, 3 cm, 170 mm  
ST03-4002 Large, 4.5 cm, 185 mm



ST03-4010  
10 mm



ST03-4011  
12 mm



ST03-4012  
14 mm

Crimping Tubes

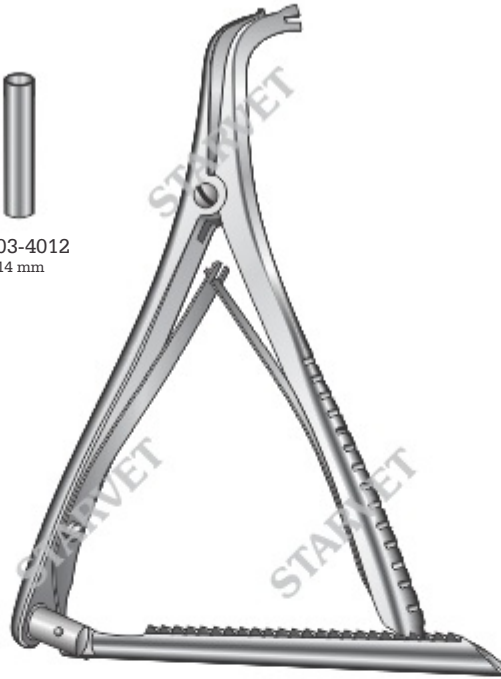

ST03-4020  
Tensioning Device  
17 cm / 6¾"



ST03-4030  
Crimping Forceps  
19.5 cm / 7¾"

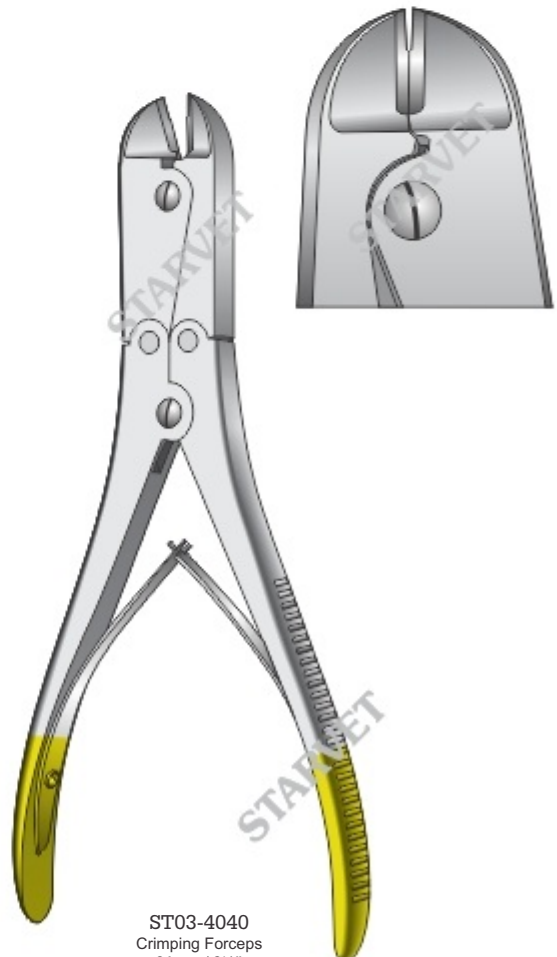

ST03-4040  
Crimping Forceps  
24 cm / 9½"



4.3 mm  
3.3 mm

ST03-4050 13 cm / 5¼"  
1.5/2.0 mm plate  
ST03-4051 14 cm / 5½"  
2.4 mm plate  
Pair Of Plate Benders



ST03-4060  
14 cm / 5½"  
2.7/3.5 mm plate  
Pair Of Plate Benders



ST03-4070 20 cm / 8"  
3.5 mm / 4.5 mm plate  
ST03-4071 24 cm / 9½"  
3.5 mm / 4.5 mm plate  
Pair Of Plate Benders

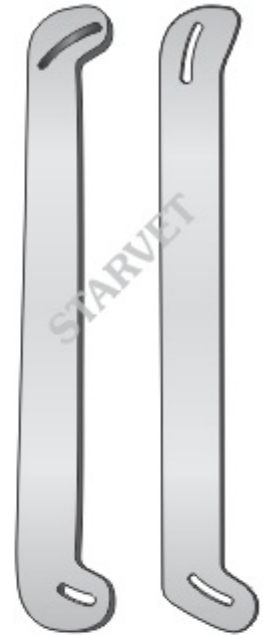

ST03-4080  
Pair Of Plate Benders



ST03-4090  
Plate Twister & Bender  
In Pair  
2.4 x 3.5 mm



ST03-4100 2.4/2.7 mm plate  
ST03-4101 2.4/3.5 mm plate  
ST03-4102 3.5 mm plate  
Plate Twister & Bender, In Pairs



ST03-4110  
2.7 mm plates  
Plate Twister & Bender, In Pairs

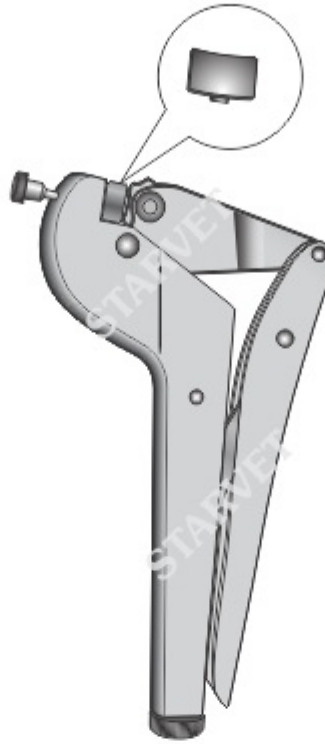

ST03-4120  
Heavy Duty Plate Bender  
with 3 anvils



Plate Bender  
ST03-4130 19 cm / 7½", Small  
ST03-4131 22 cm / 8¾", Large

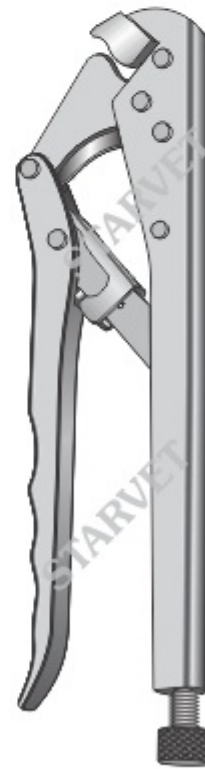

ST03-4140  
Plate Bender

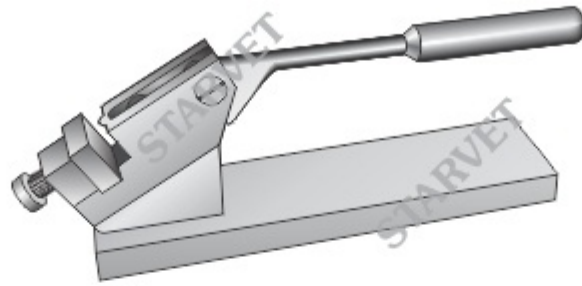

ST03-4150  
Large bone plate press  
ST03-4151  
Small bone plate press



ST03-4160 Small  
ST03-4161 Large  
Plate bending plier



ST03-4170  
Plate bending plier



Fixation Rods

	8 mm	6.3 mm	4.8 mm	3.2 mm
30 mm				ST03-4210
50 mm				ST03-4211
75 mm			ST03-4200	ST03-4212
100 mm	ST03-4180	ST03-4191	ST03-4201	ST03-4213
125 mm				ST03-4214
150 mm	ST03-4181	ST03-4192	ST03-4202	ST03-4215
200 mm		ST03-4193	ST03-4203	
240 mm	ST03-4182			
250 mm		ST03-4194	ST03-4204	
340 mm	ST03-4183	ST03-4195		

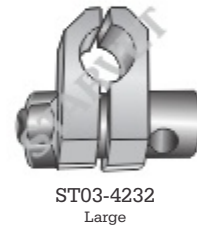



**Bone Hook**  
ST03-4260 Sharp  
ST03-4261 Blunt  
15 cm / 5 3/4"  
1 Prong, Round Handle



**Senn Muller Hook**  
ST03-4270  
15 cm / 5 3/4", Curved  
8 mm, 11 mm wide  
3-Prong, Sharp  
Round Handle



**Senn Muller Hook**  
ST03-4280  
15 cm / 5 3/4", Curved  
8 mm, 11mm wide  
3-Prong, Blunt  
Round Handle



**Senn Muller Hook**  
ST03-4290 Sharp  
ST03-4291 Blunt  
15 cm / 5 3/4"  
2 Prong, Round Handle



**Joseph Hook**  
ST03-4300 3 mm, 3 mm  
ST03-4301 6 mm, 4 mm  
ST03-4302 5 mm, 8 mm  
Curved, Wide  
15 cm / 5 3/4", Sharp  
2 Prong, Round Handle



Meyerding Retractor  
ST03-4310 6 x 4 mm  
ST03-4311 10 x 4 mm  
15 cm / 5 1/4"  
Round Handle

Meyerding Retractor  
ST03-4320 4 x 4 mm  
ST03-4321 6 x 4 mm  
15 cm / 5 1/4"  
Round Handle

Langenbeck Retractor  
ST03-4330 10 x 6 mm  
ST03-4331 11 x 4 mm  
ST03-4332 12 x 8 mm  
15cm / 5 1/4"  
Round Handle

Cushing Retractor  
ST03-4340 4 mm  
ST03-4341 6 mm  
ST03-4342 8 mm  
ST03-4343 10 mm  
ST03-4344 12 mm  
Rigid  
Round Handle

Hohmann Retractor  
ST03-4350 4 mm  
ST03-4351 5 mm  
ST03-4352 6 mm  
ST03-4353 7 mm  
ST03-4354 8 mm  
ST03-4355 10 mm  
ST03-4356 12 mm  
15 cm / 5 1/4"  
Round Handle





Scalpel Handle  
ST03-4370  
15 cm / 5 1/4"  
Straight  
Round Handle



Scalpel Handle  
ST03-4380  
15 cm / 5 1/4"  
Angled  
Round Handle



Periosteal Elevator  
ST03-4390 2 mm  
ST03-4391 3 mm  
ST03-4392 4 mm  
ST03-4393 5 mm  
ST03-4394 6 mm  
ST03-4395 7 mm  
ST03-4396 8 mm  
15 cm / 5 1/4"  
Round Handle, Slight Curved



Bone Level Elevator  
ST03-4410  
15 cm / 5 1/4"  
3 mm  
Curved to the Side  
Round Handle

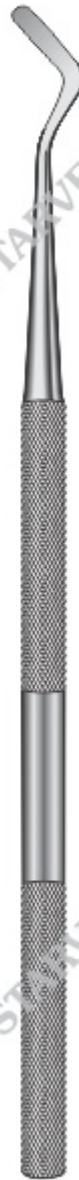

Bone Level Elevator  
ST03-4420  
15 cm / 5 1/4"  
3 mm  
Curved up  
Round Handle



**Osteotomes**

ST03-4430	2 mm
ST03-4431	3 mm
ST03-4432	4 mm
ST03-4433	5 mm
ST03-4434	6 mm
ST03-4435	7 mm
ST03-4436	8 mm
15 cm / 5 3/4"	
Round Handle	



**Gouge**

ST03-4450	2 mm
ST03-4451	4 mm
ST03-4452	6 mm
ST03-4453	7 mm
ST03-4454	8 mm
ST03-4455	10 mm
ST03-4456	12 mm
15 cm / 5 3/4"	
Round Handle	



**Chisel**

ST03-4470	2 mm
ST03-4471	3 mm
ST03-4472	4 mm
ST03-4473	5 mm
ST03-4474	6 mm
ST03-4475	7 mm
ST03-4476	8 mm
15 cm / 5 3/4"	
Round Handle	



**Bone File**

ST03-4490	3 mm
ST03-4491	4 mm
ST03-4492	5 mm
ST03-4493	6 mm
ST03-4494	7 mm
ST03-4495	8 mm
ST03-4496	10 mm
ST03-4497	12 mm
15 cm / 5 3/4"	
Round Handle	



**Bone File**

ST03-4510	Coarse
ST03-4511	Fine
15 cm / 5 3/4"	
6 mm	
Round Handle	



**Bone Awl**  
ST03-4520 2.5 mm  
ST03-4521 5 mm  
15 cm / 5 3/4"  
Round Handle



**Bone Curettes**  
ST03-4530 1 mm  
ST03-4531 2 mm  
ST03-4532 3 mm  
ST03-4533 4 mm  
ST03-4534 5 mm  
15 cm / 5 3/4"  
Round Handle, cup size



**Bone Tamper**  
ST03-4540 1 mm  
ST03-4541 2 mm  
ST03-4542 3 mm  
ST03-4543 4 mm  
ST03-4544 5 mm  
15 cm / 5 3/4"  
Round Handle



**Bone Packer**  
ST03-4550 2 mm  
ST03-4551 3 mm  
ST03-4552 4 mm  
ST03-4553 5 mm  
15 cm / 5 3/4"  
Ball Tip  
Round Handle



**Miller Colburn Curettes**  
ST03-4560 2 mm  
ST03-4561 3 mm  
ST03-4562 4 mm  
ST03-4563 5 mm  
15 cm / 5 3/4"  
Round Handle



Barraquer  
ST03-4570 Small  
ST03-4571 Large



Barraquer  
ST03-4580

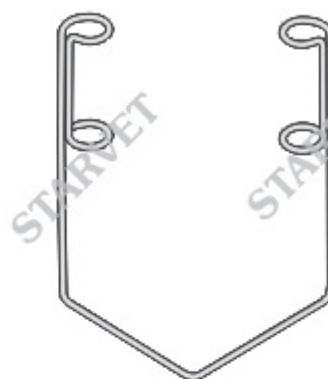

Barraquer  
ST03-4590



ST03-4600  
Large Animal  
13 mm



Mallinger Eye Ball  
ST03-4610



Knapp- Clark  
ST03-4620



Castroviejo  
ST03-4630



Stevenson  
ST03-4640



Castroviejo  
ST03-4650

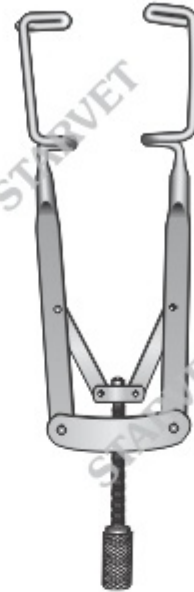

Lieberman  
ST03-4660



Lister/Burch  
ST03-4670



ST03-4680



Mueller  
ST03-4690



Goldstein  
ST03-4700



Cook  
ST03-4710 Small  
ST03-4711 Medium  
ST03-4712 Large



Roberts  
ST03-4720  
10 cm / 4"  
Tying Forceps



St Martin  
ST03-4730  
9 cm / 3½"  
1:2 Teeth  
Corneal Forceps



Castroviejo  
ST03-4740  
9 cm / 3½"  
1:2 Teeth  
Corneal Forceps



Bennet  
ST03-4745  
8 cm / 3"  
Cilia Forceps



Iris Forceps  
ST03-4750 Straight  
ST03-4751 Curved  
10.5 cm / 4½"  
Serrated



Iris Forceps  
ST03-4760 Straight  
ST03-4761 Curved  
10.5 cm / 4½"  
1:2 Teeth



Arruga  
ST03-4770  
9.5 cm / 3¾"



Arruga  
ST03-4775  
9.5 cm / 3¾"



Arruga  
ST03-4780  
10 cm / 4"



Bishop-Harmon  
ST03-4790  
8.5 cm / 3 1/4"



Castroviejo  
ST03-4800 0.3 mm  
ST03-4801 0.5 mm  
10 cm / 4"  
Suture Forceps



Fuchs  
ST03-4810  
7 cm / 2 3/4"



Tuebingen  
ST03-4820  
10 cm / 4"  
Suture Forceps



Douglas  
ST03-4830  
9 cm / 3 1/2"  
Cilia Forceps



ST03-4840



Colibri  
ST03-4850  
7 cm / 2 3/4"

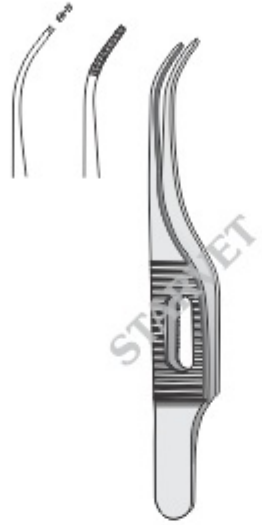

Gill-Arruga  
ST03-4860  
7.5 cm / 3"

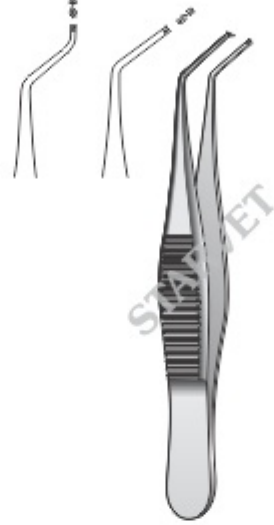

Hess (Colibri)  
ST03-4870  
7 cm / 2 3/4"

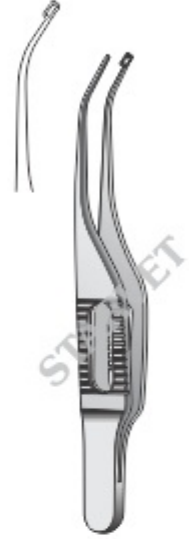

Barraquer  
ST03-4880  
7 cm / 2 3/4"

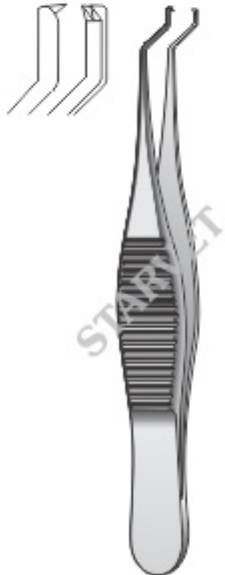

Hess  
ST03-4890  
6.5 cm / 2 1/2"



Barraquer-Katzin  
ST03-4900  
7 cm / 2 3/4"  
Colibri Forceps



Grafee  
ST03-4910  
10 cm / 4"  
3.5 mm Jaw



Grafee  
ST03-4920  
10 cm / 4"  
3.5 mm Jaw  
Forceps With Lock





Castroviejo  
ST03-4930  
10.5 cm / 4 1/2"  
Cross Action Forceps



Gradle  
ST03-4940  
9.5 cm / 3 3/4"  
Cilia Forceps



Chalazion  
ST03-4950 Small  
ST03-4951 Medium  
ST03-4952 Large



Knapp  
ST03-4960  
11 cm / 4 1/4"  
Conjunctive Forceps



Stades Nictating  
ST03-4970  
9.5 cm / 3 3/4"



ST03-4980



ST03-4990



ST03-5000



ST03-5010



Castroviejo  
ST03-5020 Straight  
ST03-5021 Curved  
11.5 cm / 4½"  
Corneal Scissors



Vannas Cataract Scissors  
ST03-5030  
8.5 cm / 3½"  
Curved

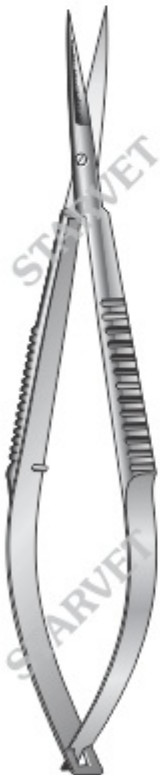

Castroviejo  
ST03-5040 Straight  
ST03-5041 Curved  
10 cm / 4"  
Sharp/Sharp Tip  
Iridectomy Scissors



Castroviejo  
ST03-5050  
10 cm / 4"  
Left  
Corneal Scissors

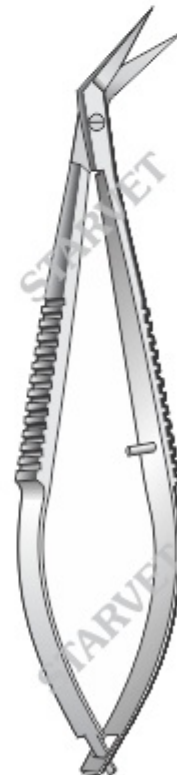

Castroviejo  
ST03-5060  
10 cm / 4"  
Right  
Corneal Scissors

These Instruments are also available with Diamond Dust Jaws  
Please add "DD" at the end of Item Code for Instruments with Diamond Dust Jaws.



With Catch	TC	Without Catch
ST03-5070	Straight	ST03-5071
ST03-5072	Curved	ST03-5073
	15 cm / 6"	
ST03-5074	Straight	ST03-5075
ST03-5076	Curved	ST03-5077
	18 cm / 7"	



**Barraquer**  
ST03-5090 11 cm / 4½"  
ST03-5091 13 cm / 5"  
Needle Holder, Curved



**Barraquer-Troutman**  
ST03-5100  
10 cm / 4"  
Needle Holder, Curved



**Boynton**  
ST03-5110 TC Jaws  
ST03-5111 Diamond Dust Jaws  
12 cm / 4¾"



**Castroviejo**  
ST03-5120 Standard Jaws  
ST03-5121 Diamond Dust Jaws  
14 cm / 5½", Straight



**Castroviejo**  
ST03-5130 Standard Jaws  
ST03-5131 Diamond Dust Jaws  
14 cm / 5½", Curved

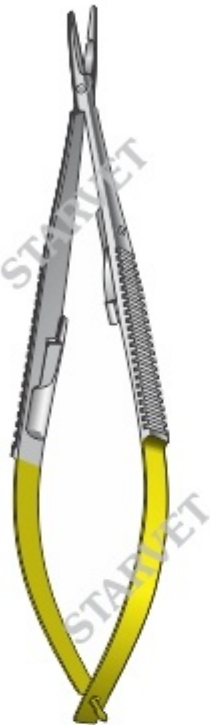

Castroviejo  
ST03-5140 Straight  
ST03-5141 Curved  
15 cm / 6"  
TC, Needle Holder & Scissors  
with lock



Castroviejo  
ST03-5150 Straight  
ST03-5151 Curved  
15 cm / 6"  
TC Super Cut, Needle Holder & Scissors  
with lock



Castroviejo  
ST03-5160 Straight  
ST03-5161 Curved  
15 cm / 6"  
TC, Needle Holder & Scissors  
without lock



Castroviejo  
ST03-5170 Straight  
ST03-5171 Curved  
15 cm / 6"  
TC Super Cut, Needle Holder & Scissors  
without lock



ST03-5180 12 mm  
ST03-5181 14 mm  
ST03-5182 16 mm  
14 cm / 5½"



**Eyelid Spatula**  
ST03-5190 10 mm  
ST03-5191 16 mm  
ST03-5192 22 mm  
ST03-5193 25 mm



ST03-5200



**Dilator**  
ST03-5210  
13 cm / 5"  
Double Ended



**Wilder Lacrimal Dilators**  
10 cm / 4"  
Single Ended



ST03-5220  
Size 1



ST03-5221  
Size 2



ST03-5222  
Size 3



**Kuhnt**  
ST03-5230  
Corneal Scraper



**Graefe**  
ST03-5240  
Iris Hook



**Meyhoefer Chalazion**  
ST03-5250 2.0 mm  
ST03-5251 2.5 mm



ST03-5255  
Fig.1



ST03-5256  
Fig. 2



**Gillies**  
18 cm / 7"  
Sharp

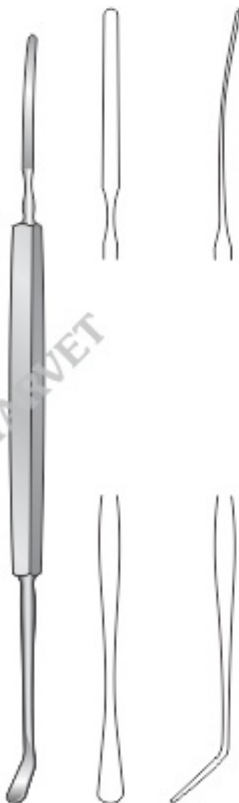

**Castroviejo Cyclodialysis**  
ST03-5260  
Dual-Ended Spatula



**Kellnar Lacrimal**  
ST03-5270  
Dilators & Tubes, Left  
8.5 cm / 3¼"



**Kellnar Lacrimal**  
ST03-5280  
Dilators & Tubes, Right  
8.5 cm / 3¼"

Cannulas



Anel Lacrimal  
ST03-5290  
Straight  
15 mm



Anel Lacrimal  
ST03-5300  
Curved  
15 mm



Lacrimal Duck  
ST03-5310  
30 mm  
Straight, olive Tip



Bonn Irrigating  
ST03-5320  
ST03-5321 Slim



Lacrimal Duck  
ST03-5330  
33 mm  
Curved



Lacrimal Duck  
ST03-5340  
33 mm  
Curved, Olive Tip



Kellnar Lacrimal Dilators  
ST03-5400 14 cm / 5½"  
Dual-Ended



Snellens Vectis  
ST03-5360  
13.5 cm 5¼"



Weber  
ST03-5370  
Wire Loop



Bowman Lacrimat  
ST03-5380  
13 cm / 5"  
Probe



ST03-5350



ST03-5390  
13 cm / 5"



ST03-5391  
13 cm / 5"

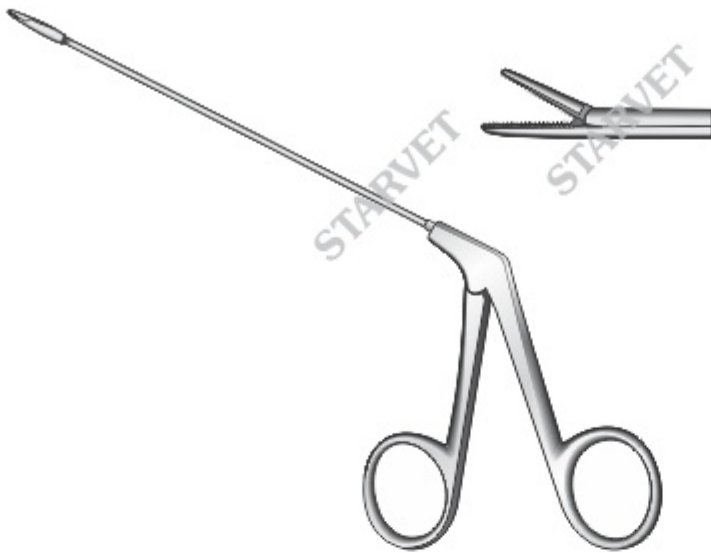

**Crocodile Forceps**  
Extra Fine, Tubular Shaft

ST03-5410	7.5 cm / 3" Shaft
ST03-5411	13 cm / 5" Shaft
ST03-5412	18 cm / 7" Shaft
ST03-5413	23 cm / 9" Shaft



**Aural Crocodile Forceps**  
Standard Jaw

ST03-5420	7.5 cm / 3" Shaft
ST03-5421	13 cm / 5" Shaft
ST03-5422	18 cm / 7" Shaft
ST03-5423	25 cm / 10" Shaft
ST03-5424	30 cm / 12" Shaft



**Cup Biopsy Forceps**

ST03-5430	2 mm ø, Shaft 75 x 3.6 mm
ST03-5431	2 mm ø, Shaft 100 x 3.6 mm
ST03-5432	3.5 x 8 mm ø, Shaft 105 x 5.6 mm



**Otoscope Head**  
Speculum Metal Closed

ST03-5440	4 x 57 mm
ST03-5441	6 x 65 mm
ST03-5442	7 x 90 mm
ST03-5443	10 x 150 mm
ST03-5444	6.5 x 40 mm



**Otoscope Head**  
ST03-5450 7 x 90 mm  
with slot



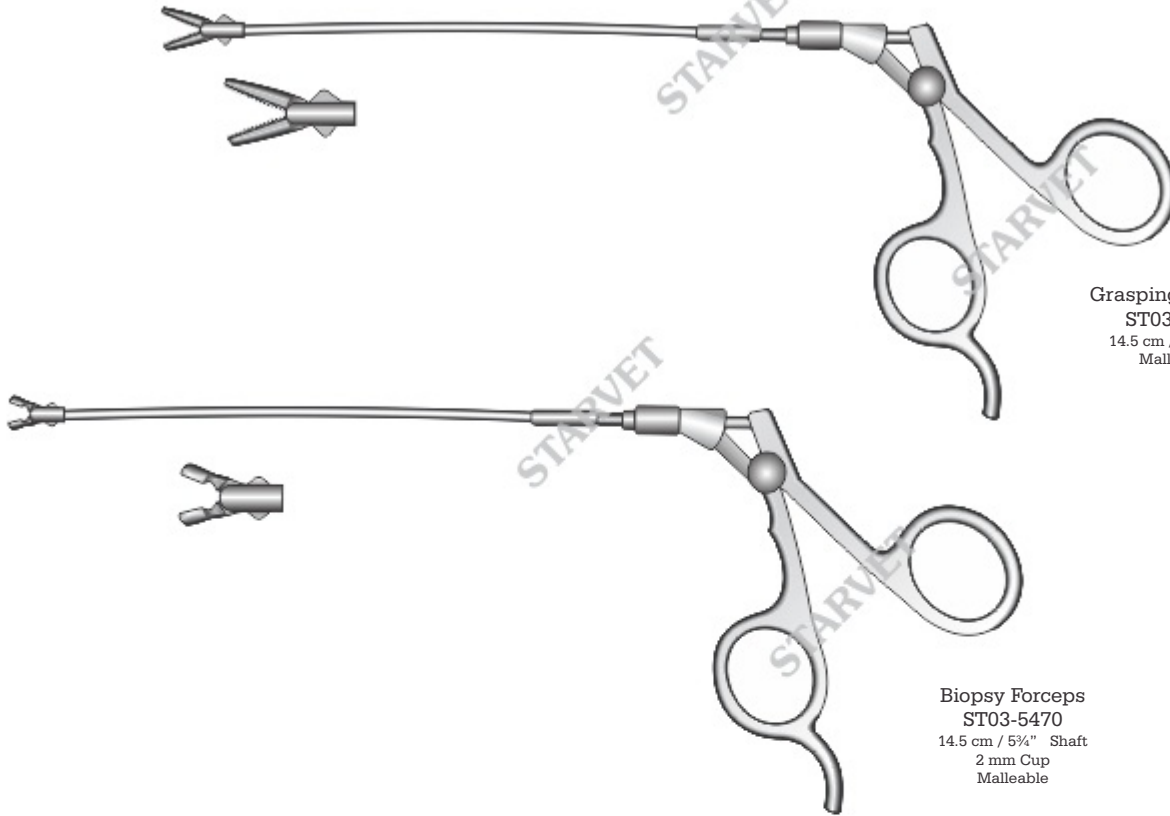

Grasping Forceps  
ST03-5460  
14.5 cm / 5¾" Shaft  
Malleable

Biopsy Forceps  
ST03-5470  
14.5 cm / 5¾" Shaft  
2 mm Cup  
Malleable

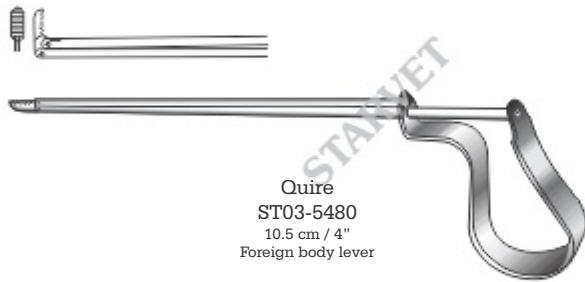

Quire  
ST03-5480  
10.5 cm / 4"  
Foreign body lever

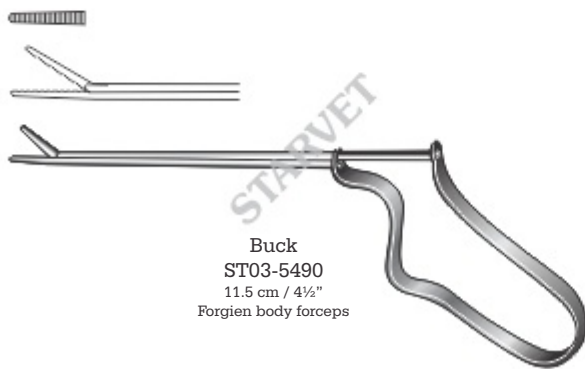

Buck  
ST03-5490  
11.5 cm / 4½"  
Foreign body forceps



Ear Loop  
ST03-5500  
Malleable  
Curette 2 mm ø

Ear Loop  
ST03-5510  
Malleable  
Curette 4 mm ø

Ear Loop  
ST03-5520  
17 cm / 6¾"



**Killian**  
13 cm / 5"



**Killian**  
13 cm / 5"  
Black Finish

ST03-5530	Standard	ST03-5531
ST03-5532	With Fiber Optics	ST03-5533
	Stainless Steel Finish	
ST03-5534	Standard	ST03-5535
ST03-5536	With Fiber Optics	ST03-5537
	Black Finish	
With Side Screw		Without Side Screw
	Blade Size 35 mm	

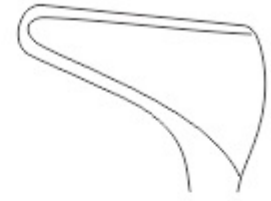

ST03-5550	Standard	ST03-5551
ST03-5552	With Fiber Optics	ST03-5553
	Stainless Steel Finish	
ST03-5554	Standard	ST03-5555
ST03-5556	With Fiber Optics	ST03-5557
	Black Finish	
With Side Screw		Without Side Screw
	Blade Size 40 mm	

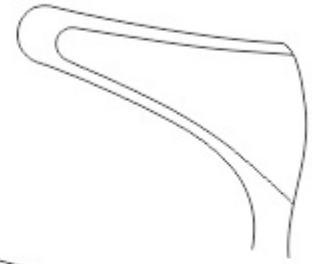

ST03-5570	Standard	ST03-5571
ST03-5572	With Fiber Optics	ST03-5573
	Stainless Steel Finish	
ST03-5574	Standard	ST03-5575
ST03-5576	With Fiber Optics	ST03-5577
	Black Finish	
With Side Screw		Without Side Screw
	Blade Size 50 mm	

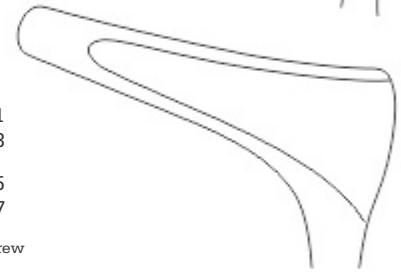

ST03-5590	Standard	ST03-5591
ST03-5592	With Fiber Optics	ST03-5593
	Stainless Steel Finish	
ST03-5594	Standard	ST03-5595
ST03-5596	With Fiber Optics	ST03-5597
	Black Finish	
With Side Screw		Without Side Screw
	Blade Size 65 mm	

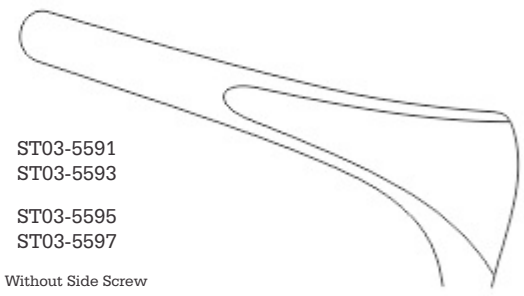

ST03-5610	Standard	ST03-5611
ST03-5612	With Fiber Optics	ST03-5613
	Stainless Steel Finish	
ST03-5614	Standard	ST03-5615
ST03-5616	With Fiber Optics	ST03-5617
	Black Finish	
With Side Screw		Without Side Screw
	Blade Size 70 mm	

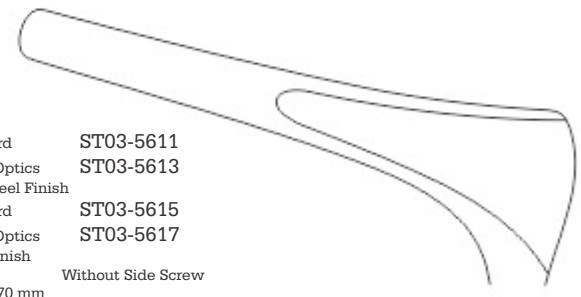

ST03-5630	Standard	ST03-5631
ST03-5632	With Fiber Optics	ST03-5633
	Stainless Steel Finish	
ST03-5634	Standard	ST03-5635
ST03-5636	With Fiber Optics	ST03-5637
	Black Finish	
With Side Screw		Without Side Screw
	Blade Size 90 mm	

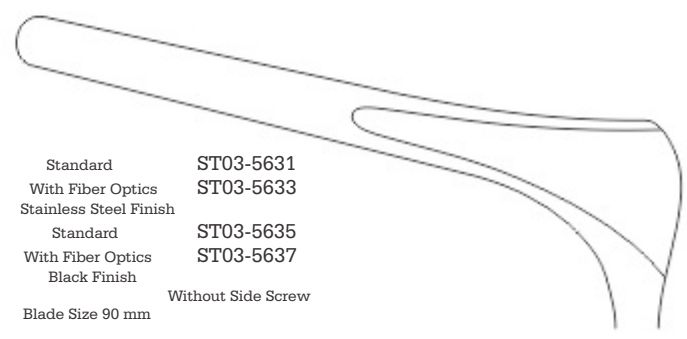



**Cottle**  
14 cm / 5½"  
Extra thin blades  
Stainless Steel Finish



**Cottle**  
14 cm / 5½"  
Extra thin blades  
Black Finish

- |                 |   |                    |
|-----------------|---|--------------------|
| ST03-5650       | Standard                                    | ST03-5651          |
| ST03-5652       | With Fiber Optics<br>Stainless Steel Finish | ST03-5653          |
| ST03-5654       | Standard                                    | ST03-5655          |
| ST03-5656       | With Fiber Optics<br>Black Finish           | ST03-5657          |
| With Side Screw |   | Without Side Screw |
|                 | Blade Size 35 mm                            |                    |



- |                 |   |                    |
|-----------------|---|--------------------|
| ST03-5670       | Standard                                    | ST03-5671          |
| ST03-5672       | With Fiber Optics<br>Stainless Steel Finish | ST03-5673          |
| ST03-5674       | Standard                                    | ST03-5675          |
| ST03-5676       | With Fiber Optics<br>Black Finish           | ST03-5677          |
| With Side Screw |   | Without Side Screw |
|                 | Blade Size 50 mm                            |                    |

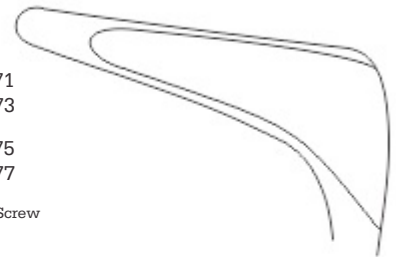

- |                 |   |                    |
|-----------------|---|--------------------|
| ST03-5690       | Standard                                    | ST03-5691          |
| ST03-5692       | With Fiber Optics<br>Stainless Steel Finish | ST03-5693          |
| ST03-5694       | Standard                                    | ST03-5695          |
| ST03-5696       | With Fiber Optics<br>Black Finish           | ST03-5697          |
| With Side Screw |   | Without Side Screw |
|                 | Blade Size 65 mm                            |                    |

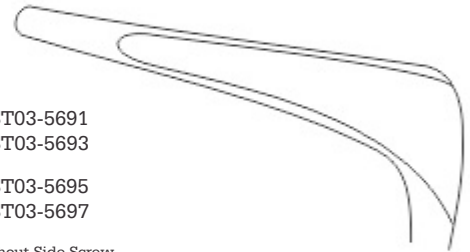

- |                 |   |                    |
|-----------------|---|--------------------|
| ST03-5710       | Standard                                    | ST03-5711          |
| ST03-5712       | With Fiber Optics<br>Stainless Steel Finish | ST03-5713          |
| ST03-5714       | Standard                                    | ST03-5715          |
| ST03-5716       | With Fiber Optics<br>Black Finish           | ST03-5717          |
| With Side Screw |   | Without Side Screw |
|                 | Blade Size 75 mm                            |                    |

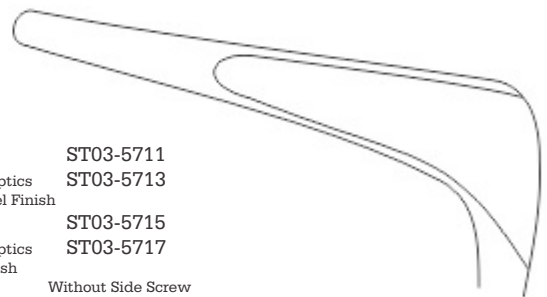

- |                 |   |                    |
|-----------------|---|--------------------|
| ST03-5730       | Standard                                    | ST03-5731          |
| ST03-5732       | With Fiber Optics<br>Stainless Steel Finish | ST03-5733          |
| ST03-5734       | Standard                                    | ST03-5735          |
| ST03-5736       | With Fiber Optics<br>Black Finish           | ST03-5737          |
| With Side Screw |   | Without Side Screw |
|                 | Blade Size 90 mm                            |                    |

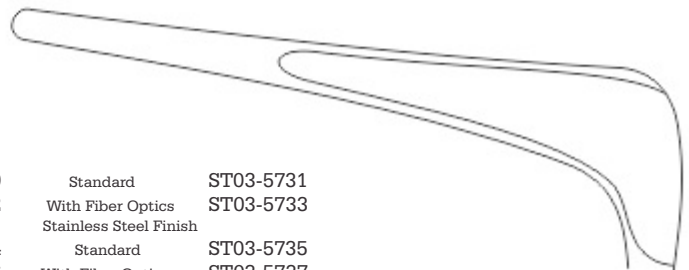



Foreign Body Forceps  
 ST03-5750 50 cm / 19 3/4"  
 ST03-5751 64 cm / 25 1/4"  
 With Ratchet



Foreign Body Forceps  
 ST03-5760 50 cm / 19 3/4"  
 ST03-5761 64 cm / 25 1/4"  
 Without Ratchet



Foreign Body Forceps  
 ST03-5770 22 cm / 8 1/2"    ST03-5771  
 ST03-5772 30 cm / 12"    ST03-5773  
 ST03-5774 40 cm / 15 3/4"    ST03-5775  
 Fine Jaws  
 With Ratchet                      Without Ratchet

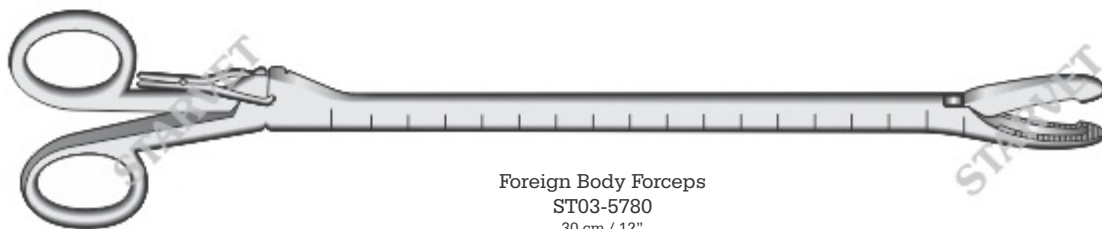

Foreign Body Forceps  
 ST03-5780  
 30 cm / 12"  
 ST03-5781  
 45 cm / 17 3/4"

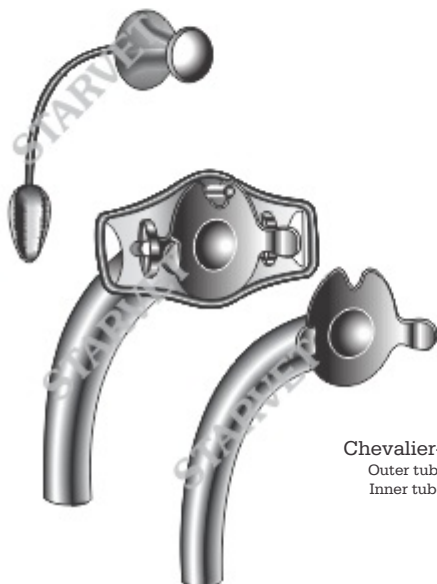
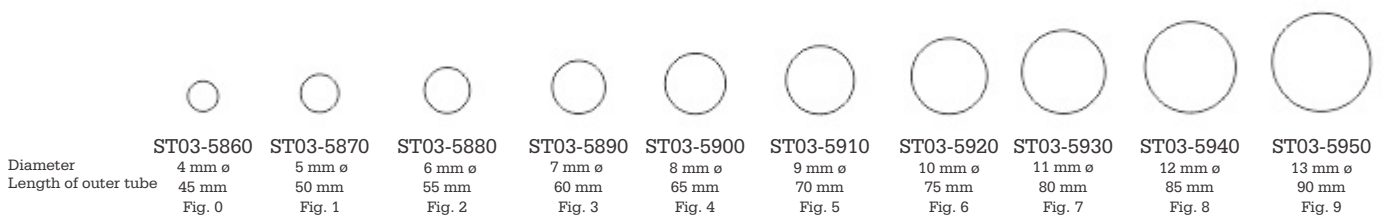
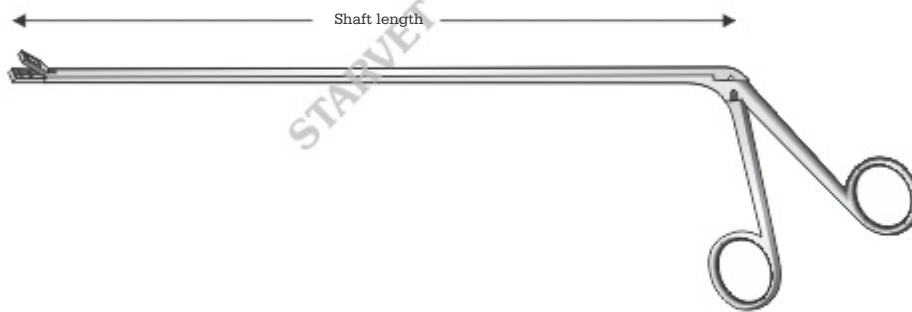





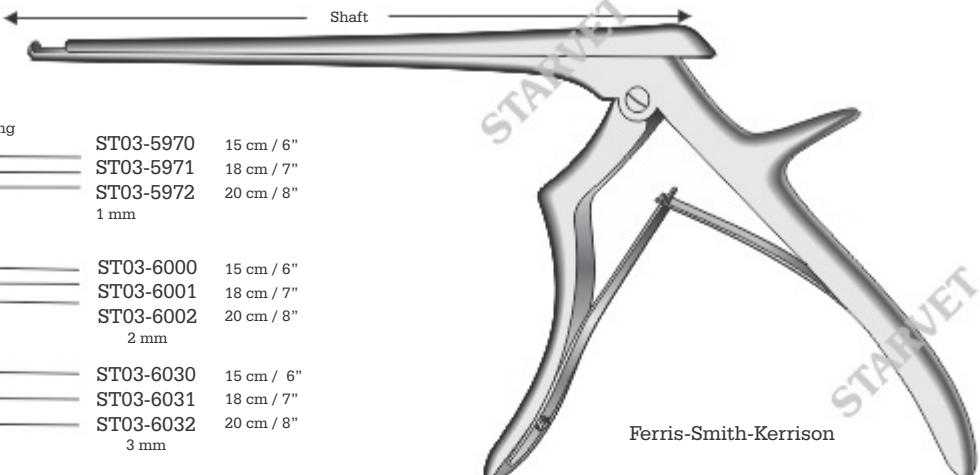



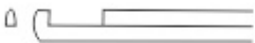

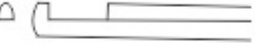

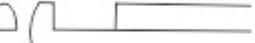

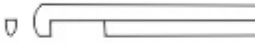





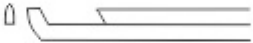

**Chevalier-Jackson**  
Outer tube closed  
Inner tube closed

← Shaft →









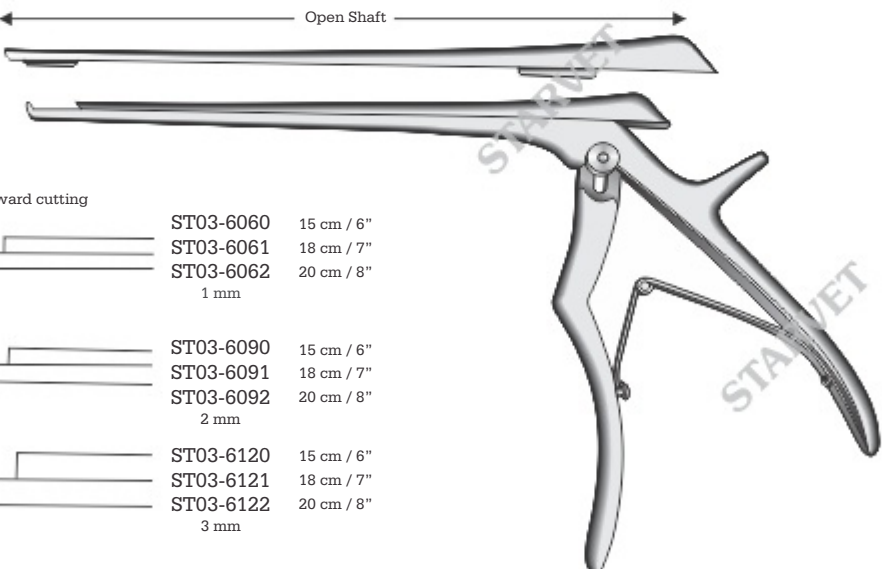



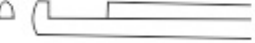





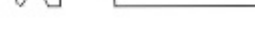

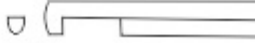



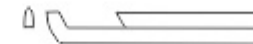

**Ferris-Smith-Kerrison**

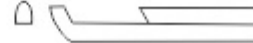
Upward cutting		ST03-5970	15 cm / 6"
		ST03-5971	18 cm / 7"
		ST03-5972	20 cm / 8"
			1 mm
		ST03-6000	15 cm / 6"
		ST03-6001	18 cm / 7"
		ST03-6002	20 cm / 8"
			2 mm
		ST03-6030	15 cm / 6"
		ST03-6031	18 cm / 7"
		ST03-6032	20 cm / 8"
			3 mm
Downward cutting		ST03-5980	15 cm / 6"
		ST03-5981	18 cm / 7"
		ST03-5982	20 cm / 8"
			1 mm
Open shaft		ST03-6010	15 cm / 6"
		ST03-6011	18 cm / 7"
		ST03-6012	20 cm / 8"
			2 mm
		ST03-6040	15 cm / 6"
		ST03-6041	18 cm / 7"
		ST03-6042	20 cm / 8"
			3 mm
Forward cutting		ST03-5990	15 cm / 6"
		ST03-5991	18 cm / 7"
		ST03-5992	20 cm / 8"
			1 mm
		ST03-6020	15 cm / 6"
		ST03-6021	18 cm / 7"
		ST03-6022	20 cm / 8"
			2 mm
		ST03-6050	15 cm / 6"
		ST03-6051	18 cm / 7"
		ST03-6052	20 cm / 8"
			3 mm





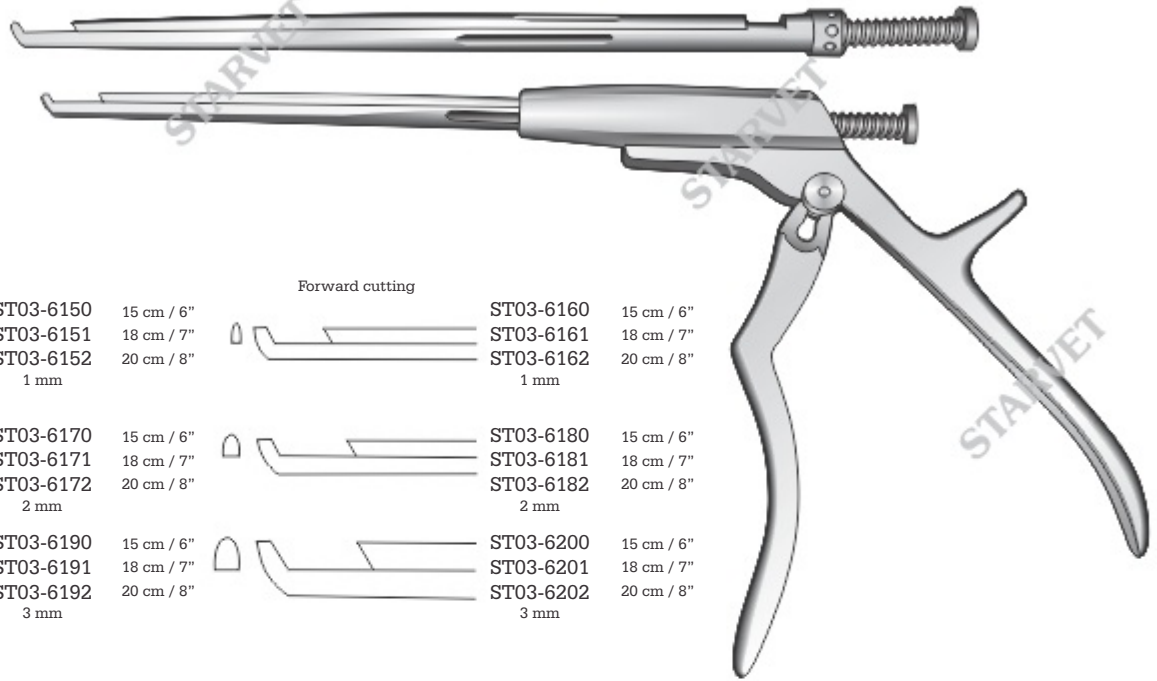

← Open Shaft →





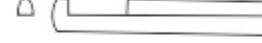

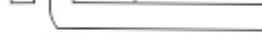



Upward cutting		ST03-6060	15 cm / 6"
		ST03-6061	18 cm / 7"
		ST03-6062	20 cm / 8"
			1 mm
		ST03-6090	15 cm / 6"
		ST03-6091	18 cm / 7"
		ST03-6092	20 cm / 8"
			2 mm
		ST03-6120	15 cm / 6"
		ST03-6121	18 cm / 7"
		ST03-6122	20 cm / 8"
			3 mm
Downward cutting		ST03-6070	15 cm / 6"
		ST03-6071	18 cm / 7"
		ST03-6072	20 cm / 8"
			1 mm
		ST03-6100	15 cm / 6"
		ST03-6101	18 cm / 7"
		ST03-6102	20 cm / 8"
			2 mm
		ST03-6130	15 cm / 6"
		ST03-6131	18 cm / 7"
		ST03-6132	20 cm / 8"
			3 mm
Forward cutting		ST03-6080	15 cm / 6"
		ST03-6081	18 cm / 7"
		ST03-6082	20 cm / 8"
			1 mm
		ST03-6110	15 cm / 6"
		ST03-6111	18 cm / 7"
		ST03-6112	20 cm / 8"
			2 mm
		ST03-6140	15 cm / 6"
		ST03-6141	18 cm / 7"
		ST03-6142	20 cm / 8"
			3 mm





Upward cutting

	ST03-6150	15 cm / 6"
	ST03-6151	18 cm / 7"
	ST03-6152	20 cm / 8"
	1 mm	
	ST03-6170	15 cm / 6"
	ST03-6171	18 cm / 7"
	ST03-6172	20 cm / 8"
	2 mm	
	ST03-6190	15 cm / 6"
	ST03-6191	18 cm / 7"
	ST03-6192	20 cm / 8"
	3 mm	



Forward cutting

	ST03-6160	15 cm / 6"
	ST03-6161	18 cm / 7"
	ST03-6162	20 cm / 8"
	1 mm	
	ST03-6180	15 cm / 6"
	ST03-6181	18 cm / 7"
	ST03-6182	20 cm / 8"
	2 mm	
	ST03-6200	15 cm / 6"
	ST03-6201	18 cm / 7"
	ST03-6202	20 cm / 8"
	3 mm	



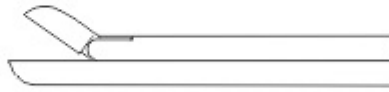

	ST03-6210	2 x 10 mm
	ST03-6211	3 x 10 mm
	ST03-6212	4 x 10 mm

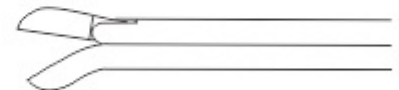

	ST03-6220	2 x 10 mm
	ST03-6221	3 x 10 mm
	ST03-6222	4 x 10 mm



	ST03-6230	2 x 10 mm
	ST03-6231	3 x 10 mm
	ST03-6232	4 x 10 mm

18 cm / 7"



Ferris-Smith-Cushing

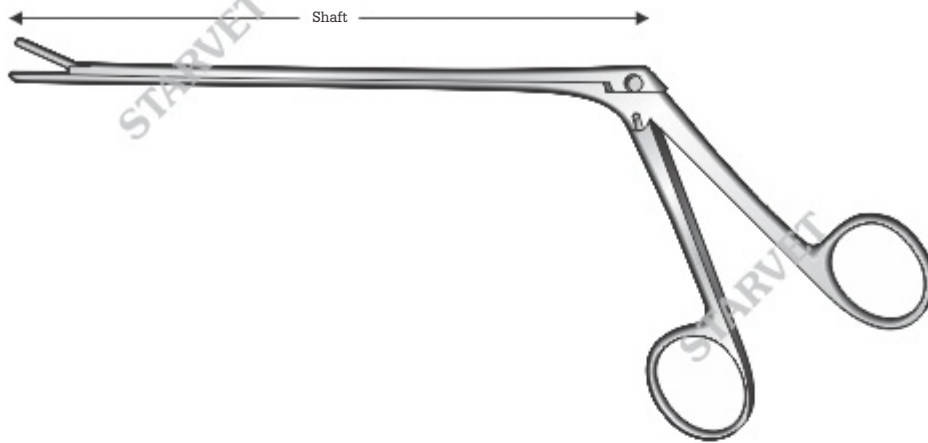

**Love Gruenwald**  
ST03-6240 12 cm / 4 3/4"  
ST03-6241 15 cm / 6"  
ST03-6242 18 cm / 7"  
3 x 10 mm  
Straight

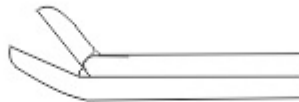

**Love Gruenwald**  
ST03-6250 12 cm / 4 3/4"  
ST03-6251 15 cm / 6"  
ST03-6252 18 cm / 7"  
3 x 10 mm  
Angled at 45°  
Upward

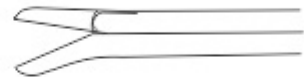

**Love Gruenwald**  
ST03-6260 12 cm / 4 3/4"  
ST03-6261 15 cm / 6"  
ST03-6262 18 cm / 7"  
3 x 10 mm  
Angled at 45°  
Downward

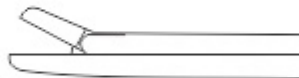

**Cushing**  
ST03-6270 12 cm / 4 3/4"  
ST03-6271 15 cm / 6"  
ST03-6272 18 cm / 7"  
2 x 10 mm  
Straight



**Cushing**  
ST03-6280 12 cm / 4 3/4"  
ST03-6281 15 cm / 6"  
ST03-6282 18 cm / 7"  
2 x 10 mm  
Angled at 45°, Upward



**Cushing**  
ST03-6290 12 cm / 4 3/4"  
ST03-6291 15 cm / 6"  
ST03-6292 18 cm / 7"  
2 x 10 mm  
Angled at 45°, Downward

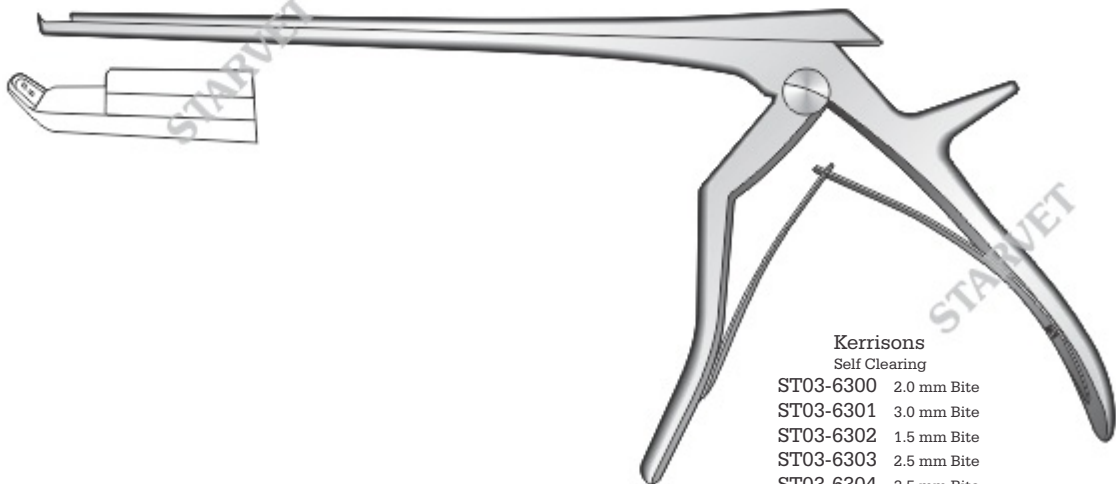

**Kerrisons**  
Self Clearing  
ST03-6300 2.0 mm Bite  
ST03-6301 3.0 mm Bite  
ST03-6302 1.5 mm Bite  
ST03-6303 2.5 mm Bite  
ST03-6304 3.5 mm Bite  
21 cm / 8 1/4" Shaft





Bone Distractor  
ST03-6310  
Outspread Arm  
Large



Bone Distractor  
ST03-6320  
Closed Arm  
Large



Bone Distractor  
ST03-6330  
Outspread Arm  
Small



Bone Distractor  
ST03-6340  
Closed Arm  
Small



Spinal Distracter  
ST03-6350  
Joint & Calcaneal Spreader

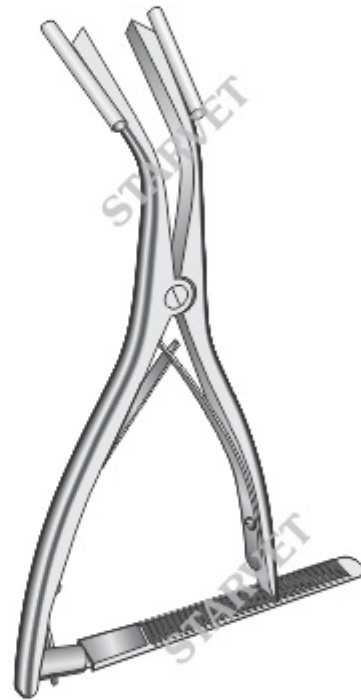

Weinraub  
ST03-6360  
Joint & Calcaneal Spreader

Mouth Gag

- ST04-0001 5 cm / 2", Extra Small
  - ST04-0002 8 cm / 3", Small
  - ST04-0003 12 cm / 4 3/4", Medium
- Light Model



Mouth Gag

- ST04-0020 6 cm / 2 1/2", Extra Small
  - ST04-0021 9 cm / 3 1/2", Small
  - ST04-0022 11 cm 4/4", Medium
  - ST04-0023 14 cm / 5 1/2", Large
  - ST04-0024 18 cm / 7", Extra Large
- Light Model



Gray  
Mouth Gag

- ST04-0040 4 cm / 1 1/2", X Small
- ST04-0041 6.5 cm / 2 1/2", Small
- ST04-0042 10 cm / 4", Medium
- ST04-0043 14 cm / 5 1/2", Large
- ST04-0044 18 cm / 7", X Large



Smith Baxter

- ST04-0010 5.5 cm / 2 1/4", XX Small
- ST04-0011 6.5 cm / 2 1/2", X Small
- ST04-0012 10 cm / 4", Small
- ST04-0013 14 cm / 5 1/2", Medium
- ST04-0014 15.5 cm / 6", Large
- ST04-0015 17 cm / 6 3/4", X Large



Mouth Gag

- ST04-0030 7 cm / 2 3/4", Extra Small
- ST04-0031 9 cm / 3 1/2", Small
- ST04-0032 12 cm / 4 3/4", Medium
- ST04-0033 17 cm / 6 3/4", Large



Mouth Gag

- ST04-0050 6 cm / 2 1/2", Extra Small
- ST04-0051 11 cm 4/4", Small
- ST04-0052 14 cm / 5 1/2", Medium
- ST04-0053 18 cm / 7", Large



These Instruments are also available with Diamond Dust Jaws  
Please add "DD" at the end of Item Code for Instruments with Diamond Dust Jaws.



Tarter Forcep  
ST04-0060



ST04-0070

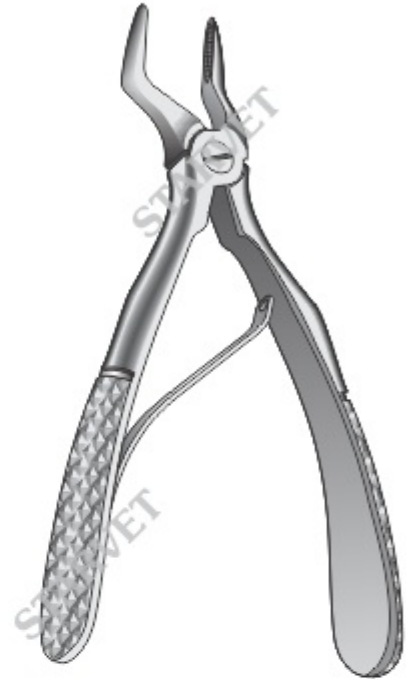

Klein  
ST04-0080  
Fig. 515



Klein  
ST04-0090  
Fig. 5



Klein  
ST04-0100  
Fig. 139

These Instruments are also available with Diamond Dust Jaws  
Please add "DD" at the end of Item Code for Instruments with Diamond Dust Jaws.



Extraction Forceps  
ST04-0110



Tartar Forceps  
ST04-0120 Small  
ST04-0121 Large



Right Angled Forceps  
ST04-0130 Standard Jaws  
ST04-0131 Diamond Dust coated Jaws



Tartar Forceps  
ST04-0140 Small  
ST04-0141 Large  
Diamond Dust coated Jaws



Tartar Removing Forceps  
ST04-0150 Standard Jaws  
ST04-0151 Diamond Dust coated Jaws

These Instruments are also available with Diamond Dust Jaws  
Please add "DD" at the end of Item Code for Instruments with Diamond Dust Jaws.

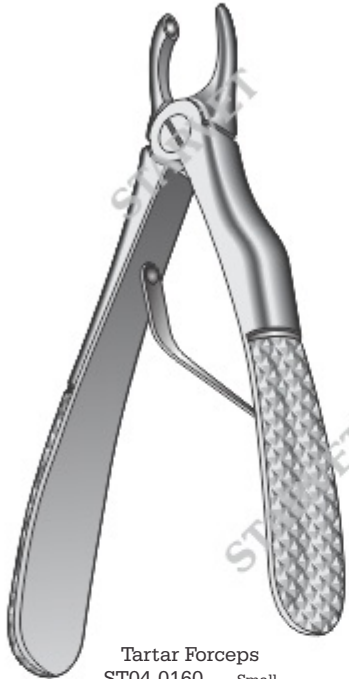

Tartar Forceps  
ST04-0160 Small  
ST04-0161 Large



ST04-0170

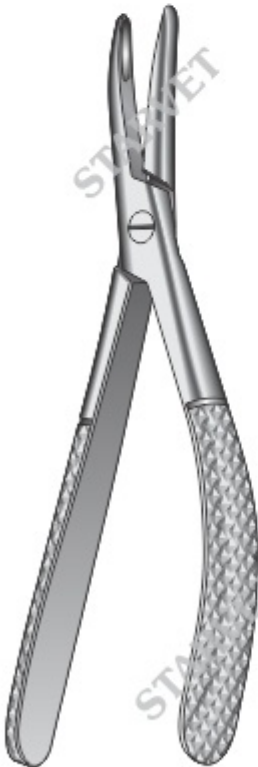

Maller Feliner  
ST04-0180 Small  
ST04-0182 Large

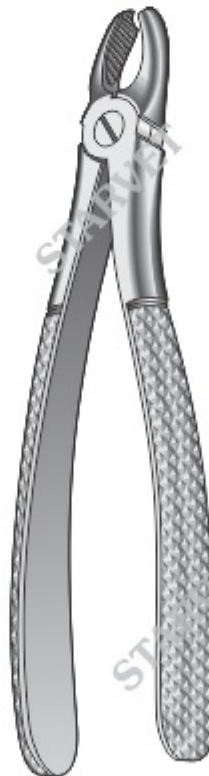

Hawks Bill Forceps  
ST04-0190 Small  
ST04-0192 Large

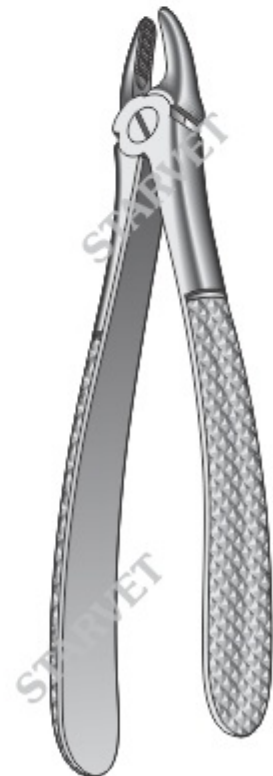

ST04-0200 Small  
ST04-0202 Large

These Instruments are also available with Diamond Dust Jaws  
Please add "DD" at the end of Item Code for Instruments with Diamond Dust Jaws.

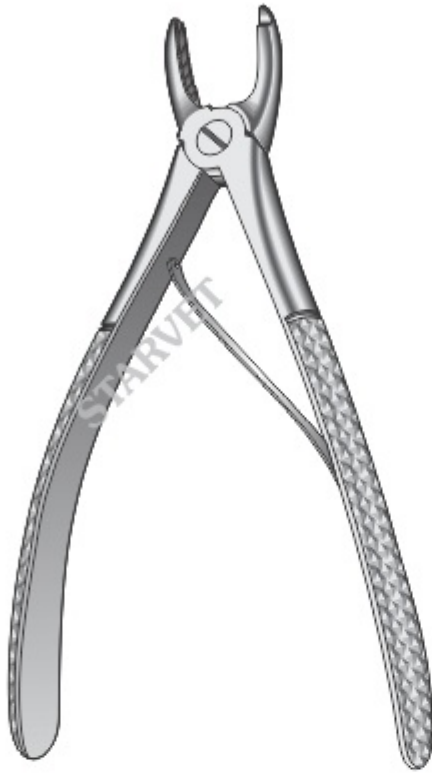

Tartar Extracting Forceps  
ST04-0210

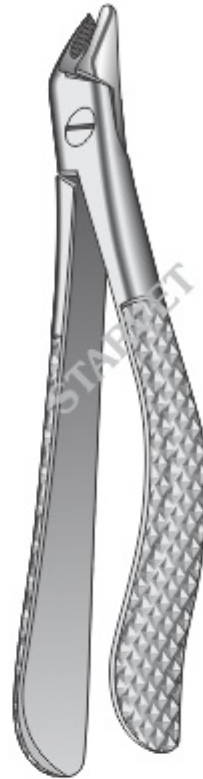

Tartar Extracting Forceps  
ST04-0220  
Narrow Tip



Tartar Extracting Forceps  
ST04-0230  
Curved

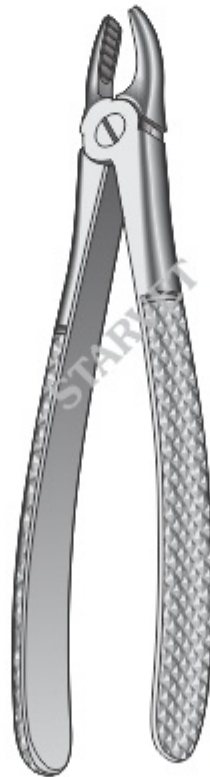

Tartar Extracting Forceps  
ST04-0240  
Straight

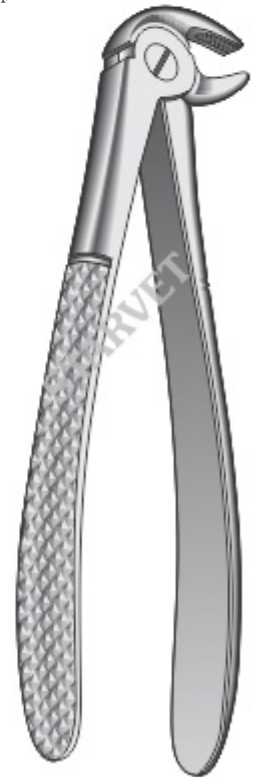

Tartar Extracting Forceps  
ST04-0250  
Angled

These Instruments are also available with Diamond Dust Jaws  
Please add "DD" at the end of Item Code for Instruments with Diamond Dust Jaws.

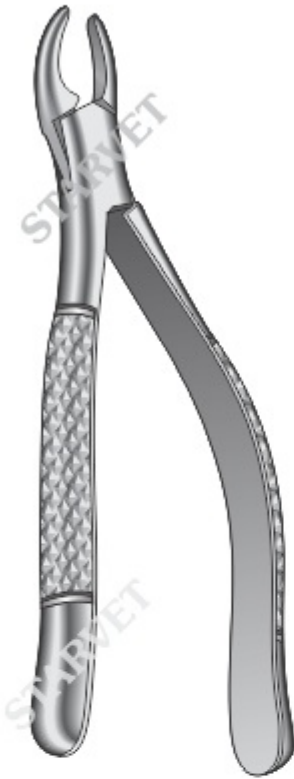

Extracting Forceps  
ST04-0260



Extracting Forceps  
ST04-0270

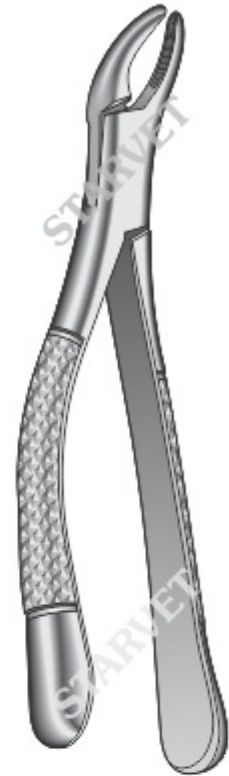

Extracting Forceps  
ST04-0280

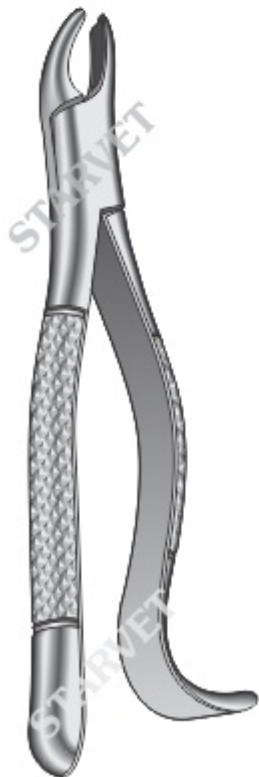

Extracting Forceps  
ST04-0290

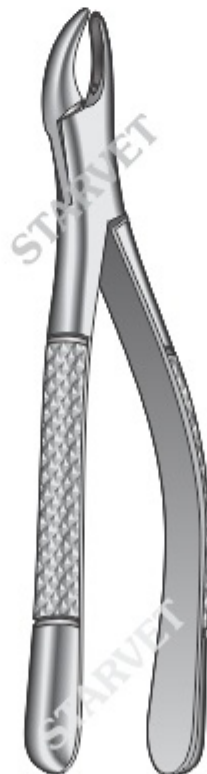

Extracting Forceps  
ST04-0300

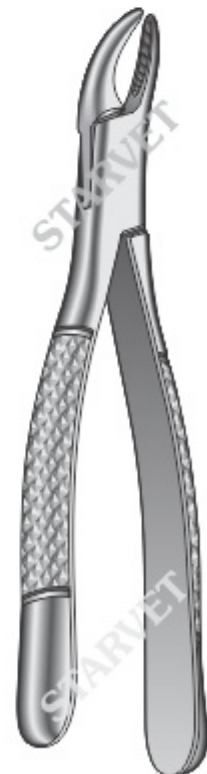

Extracting Forceps  
ST04-0310



These Instruments are also available with Diamond Dust Jaws  
Please add "DD" at the end of Item Code for Instruments with Diamond Dust Jaws.



Cryer  
Extracting Forceps  
ST04-0320

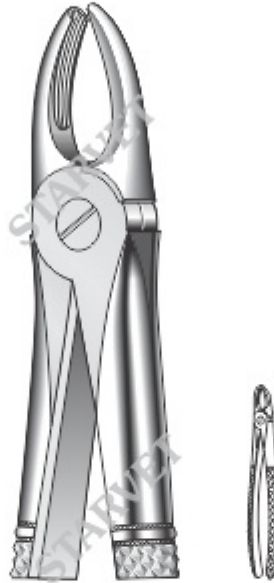

Extracting Forceps  
ST04-0325



Extracting Forceps  
ST04-0330



Cryer  
Extracting Forceps  
ST04-0335



Klein  
Extracting Forceps  
ST04-0340



Dental Mash Cutter  
ST04-0345

These Instruments are also available with Diamond Dust Jaws  
Please add "DD" at the end of Item Code for Instruments with Diamond Dust Jaws.



Root fragment Forceps  
ST04-0350

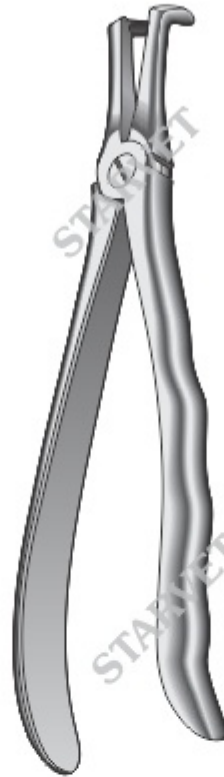

Root Fragment Forceps  
ST04-0360  
Root Fragment Set  
ST04-0361  
Consisting of 3 Forceps

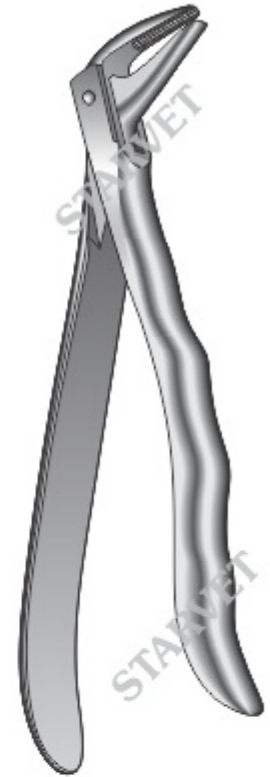

Root fragment Forceps  
ST04-0370



Fragment Extracting Forceps  
ST04-0380

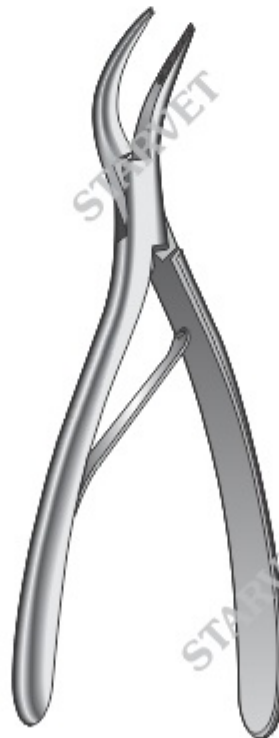

Root Tip Extracting Forceps  
ST04-0390



Root Tip Extracting Forceps  
ST04-0395



ST04-0400  
Supraperiapal Scaler



ST04-0410  
Supraperiapal Scaler



ST04-0420  
Supraperiapal Scaler



ST04-0430  
Supraperiapal Scaler



ST04-0440  
Supraperiapal Scaler



ST04-0450  
Supraperiapal Scaler



Kaplan  
ST04-0460  
Double Ended



Kaplan  
ST04-0470  
Double Ended



Kaplan  
ST04-0480  
Double Ended



Kaplan  
ST04-0490  
Double Ended



Kaplan  
ST04-0500  
Double Ended



Kaplan  
ST04-0510  
Double Ended



Canine  
ST04-0520  
Tarter Scraper



Canine  
ST04-0530  
Tarter Scraper



Canine  
ST04-0540  
Tarter Scraper



Canine  
ST04-0550  
Tarter Scraper



Canine  
ST04-0560  
Tarter Scraper



Canine  
ST04-0570  
Tarter Scraper



ST04-0580  
Supragingival  
Curette



ST04-0590  
Supragingival  
Curette



ST04-0600  
Supragingival  
Curette



ST04-0610  
Supragingival  
Curette



ST04-0620  
Supragingival  
Curette



ST04-0630  
Supragingival  
Curette



Jaquette  
ST04-0640  
Scaler



Jaquette  
ST04-0650  
Scaler



Jaquette  
ST04-0660  
Scaler



Jaquette  
ST04-0670  
Scaler



Jaquette  
ST04-0680  
Scaler



Jaquette  
ST04-0690  
Scaler



ST04-0700  
Scaler



ST04-0710  
Scaler



ST04-0720  
Scaler



ST04-0730  
Scaler



ST04-0740  
Scaler



ST04-0750  
Scaler



Mc Call  
ST04-0760  
Scaler



Mc Call  
ST04-0770  
Scaler



Mc Call  
ST04-0780  
Scaler



Mc Call  
ST04-0790  
Scaler



Mc Call  
ST04-0800  
Scaler



Mc Call  
ST04-0810  
Scaler



Mc Call  
ST04-0820  
Scaler



Mc Call  
ST04-0830  
Scaler



Mc Call  
ST04-0840  
Scaler



Mc Call  
ST04-0850  
Scaler



Mc Call  
ST04-0860  
Scaler



Mc Call  
ST04-0870  
Scaler



ST04-0880



ST04-0890



ST04-0900



ST04-0910



ST04-0920



ST04-0930



Sickle Scaler  
ST04-0940  
Curved



Sickle Scaler  
ST04-0950  
Curved



Sickle Scaler  
ST04-0960  
Curved



Sickle Scaler  
ST04-0970  
Curved



Sickle Scaler  
ST04-0980  
Curved



Sickle Scaler  
ST04-0990  
Curved



Mearuing Probe  
ST04-1000



Mearuing Probe  
ST04-1010



Mearuing Probe  
ST04-1020



Mearuing Probe  
ST04-1030



Mearuing Probe  
ST04-1040



Mearuing Probe  
ST04-1050



Kaplan  
ST04-1060  
Scaler



Kaplan  
ST04-1070  
Scaler



Kaplan  
ST04-1080  
Scaler



Kaplan  
ST04-1090  
Scaler



Kaplan  
ST04-1100  
Scaler



Kaplan  
ST04-1110  
Scaler





Jaquette  
ST04-1120  
Scaler



Jaquette  
ST04-1130  
Scaler



Jaquette  
ST04-1140  
Scaler



Jaquette  
ST04-1150  
Scaler



Jaquette  
ST04-1160  
Scaler



Jaquette  
ST04-1170  
Scaler



Probe/Explorer  
ST04-1180



Probe/Explorer  
ST04-1190



Probe/Explorer  
ST04-1200



Probe/Explorer  
ST04-1210



Probe/Explorer  
ST04-1220



Probe/Explorer  
ST04-1230



ST04-1240



ST04-1250



ST04-1260



ST04-1270



ST04-1280



ST04-1290



Resorptive Lesion  
ST04-1300  
Probe



Resorptive Lesion  
ST04-1310  
Probe



Resorptive Lesion  
ST04-1320  
Probe



Resorptive Lesion  
ST04-1330  
Probe



Resorptive Lesion  
ST04-1340  
Probe



Resorptive Lesion  
ST04-1350  
Probe



ST04-1360



ST04-1370



ST04-1380



ST04-1390



ST04-1400



ST04-1410



Explorer & Mearuing  
Probe  
ST04-1420



Explorer & Mearuing  
Probe  
ST04-1430



Explorer & Mearuing  
Probe  
ST04-1440



Explorer & Mearuing  
Probe  
ST04-1450



Explorer & Mearuing  
Probe  
ST04-1460



Explorer & Mearuing  
Probe  
ST04-1470



ST04-1480



ST04-1485



ST04-1490



ST04-1495



ST04-1500



ST04-1510



ST04-1515



ST04-1520



ST04-1525



ST04-1530



ST04-1535



ST04-1540



O.M.S.  
ST04-1545  
CP-11



ST04-1550



Gracey  
ST04-1555  
Fig. 7/8



Barnhart  
ST04-1560  
Fig. 5/6



Cattoni  
ST04-1565  
Fig. 23/17



Columbia  
ST04-1570  
4R/4L



Columbia  
ST04-1575  
13/14



Goldman-Fox  
ST04-1580

Towner-Jaquette  
ST04-1585  
15/30

Gracey  
ST04-1590  
Fig. 1/2

Gracey  
ST04-1591  
11/12

Gracey  
ST04-1592  
13/14

Langer  
ST04-1595  
5/6

Mc Call  
ST04-1600  
11/12



Tooth Scaler  
ST04-1610  
Right



Tooth Scaler  
ST04-1615  
Right



Tooth Scaler  
ST04-1620  
Right



Tooth Scaler  
ST04-1630  
Right



Tooth Scaler  
ST04-1640  
Right



Tooth Scaler  
ST04-1650  
Right



Tooth Scaler  
ST04-1660  
Left



Tooth Scaler  
ST04-1670  
Left



Tooth Scaler  
ST04-1680  
Left



Tooth Scaler  
ST04-1690  
Left



Tooth Scaler  
ST04-1700  
Left



Tooth Scaler  
ST04-1710  
Left



ST04-1720



ST04-1730



ST04-1740



ST04-1750



Single Ended Scraper  
ST04-1760



ST04-1770



ST04-1780





ST04-1790



ST04-1800



ST04-1810



ST04-1820



Mirror  
ST04-1830  
Double Ended



Mirror  
ST04-1840  
Double Ended



Mirror  
ST04-1850  
Double Ended



Mirror  
ST04-1860  
Double Ended



Mirror  
ST04-1870  
Double Ended



Mirror  
ST04-1880  
Double Ended



ST04-1890



ST04-1900



ST04-1910



ST04-1920



ST04-1930



ST04-1940



ST04-1950



ST04-1960



ST04-1970



ST04-1980



ST04-1990



ST04-2000



ST04-2010



ST04-2020



ST04-2030



ST04-2040



ST04-2050



ST04-2060



ST04-2070



ST04-2080



ST04-2090



ST04-2100

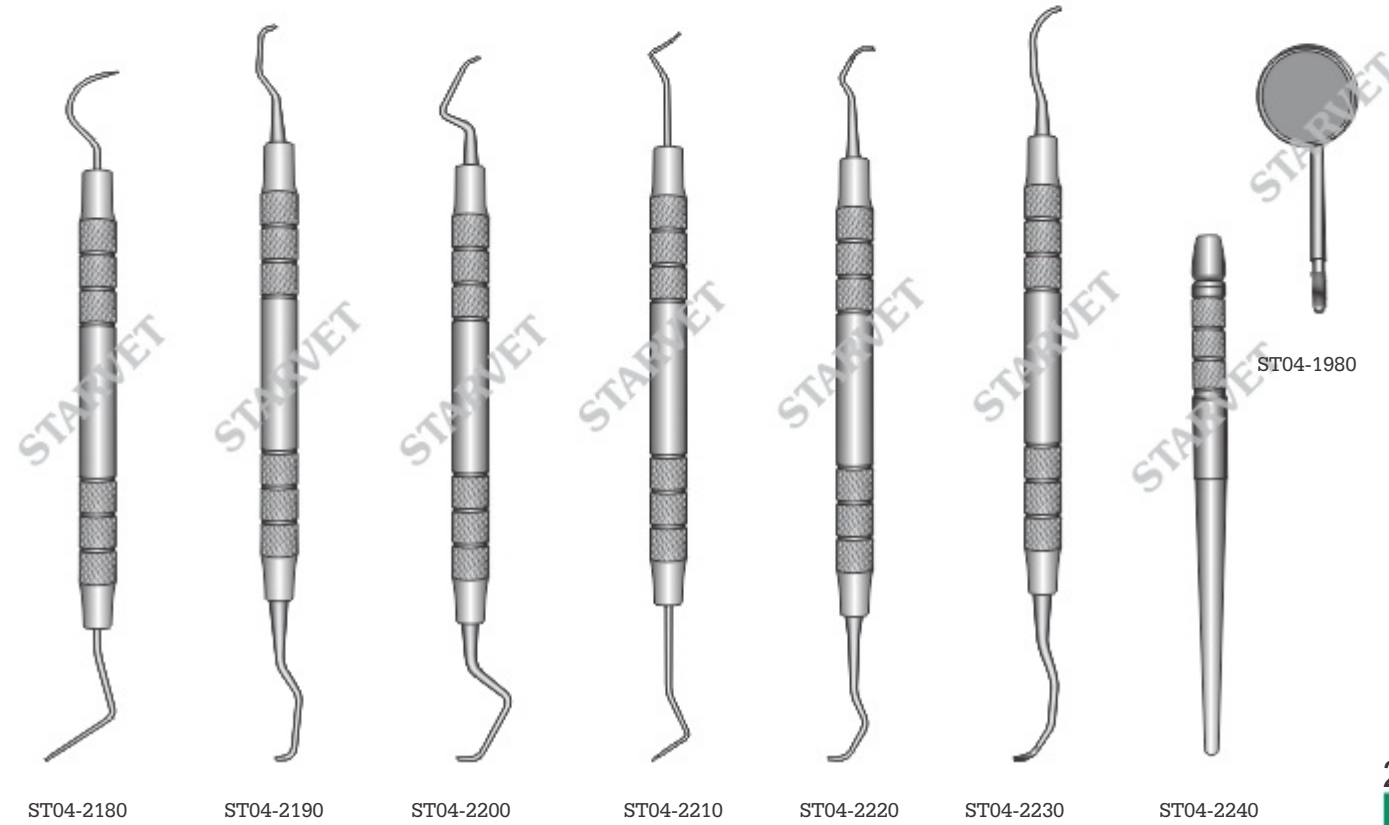
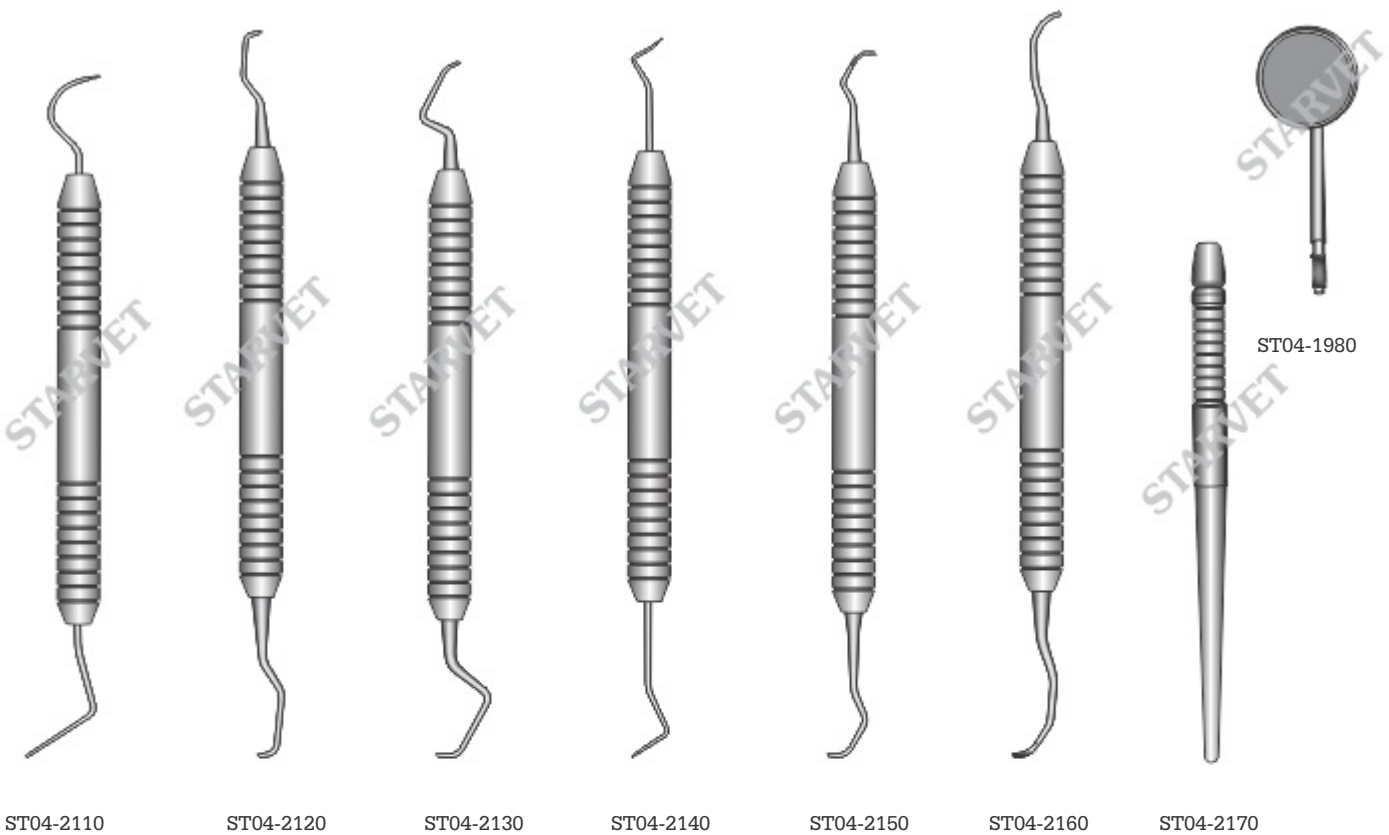



ST04-2250



ST04-2260



ST04-2270



ST04-2280



ST04-2290



ST04-2300



ST04-2310



ST04-2320



ST04-2330



ST04-2340



ST04-2350



ST04-2360



ST04-2370



ST04-2380



ST04-2390



ST04-2400



ST04-2410



ST04-2420



ST04-2430



ST04-2440



ST04-2450



ST04-2460



ST04-2470



ST04-2480





ST04-2490

ST04-2491

ST04-2492



ST04-2500

ST04-2501

ST04-2502



ST04-2510

ST04-2511

ST04-2512



ST04-2530

ST04-2531

ST04-2632

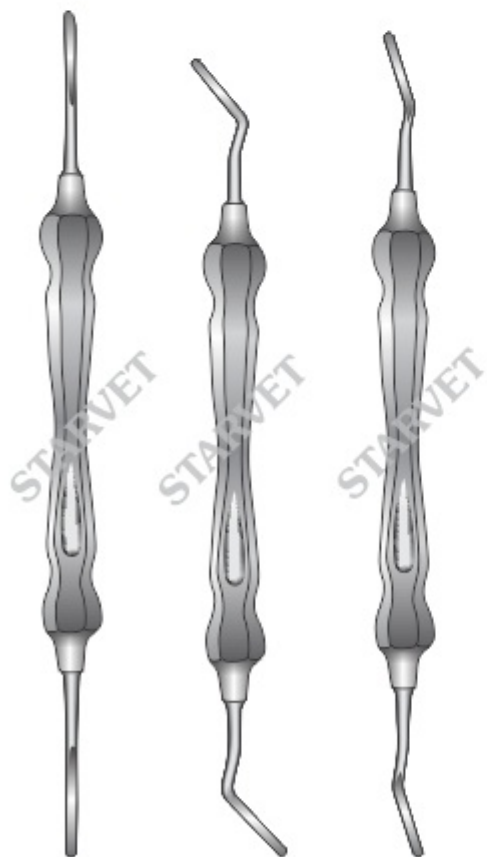

ST04-2540

ST04-2541

ST04-2542

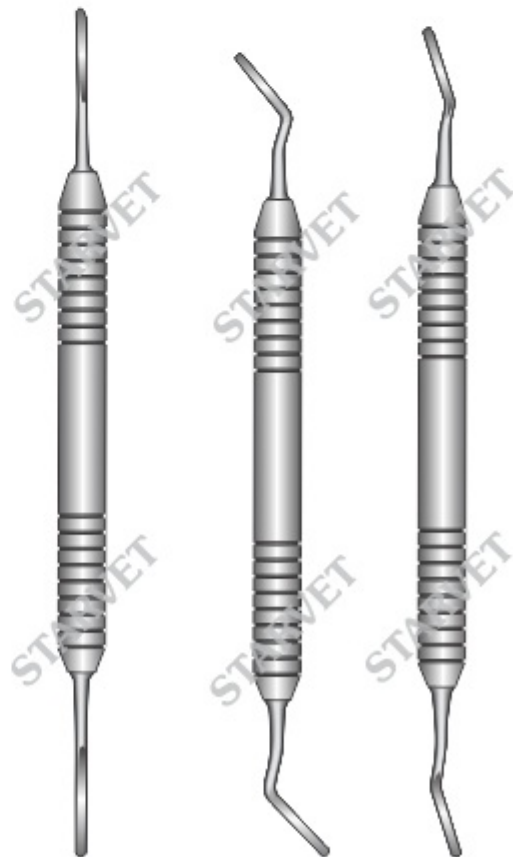

ST04-2550

ST04-2551

ST04-2552



ST04-2570      ST04-2571      ST04-2572



ST04-2580      ST04-2581      ST04-2582



ST04-2590      ST04-2591      ST04-2592

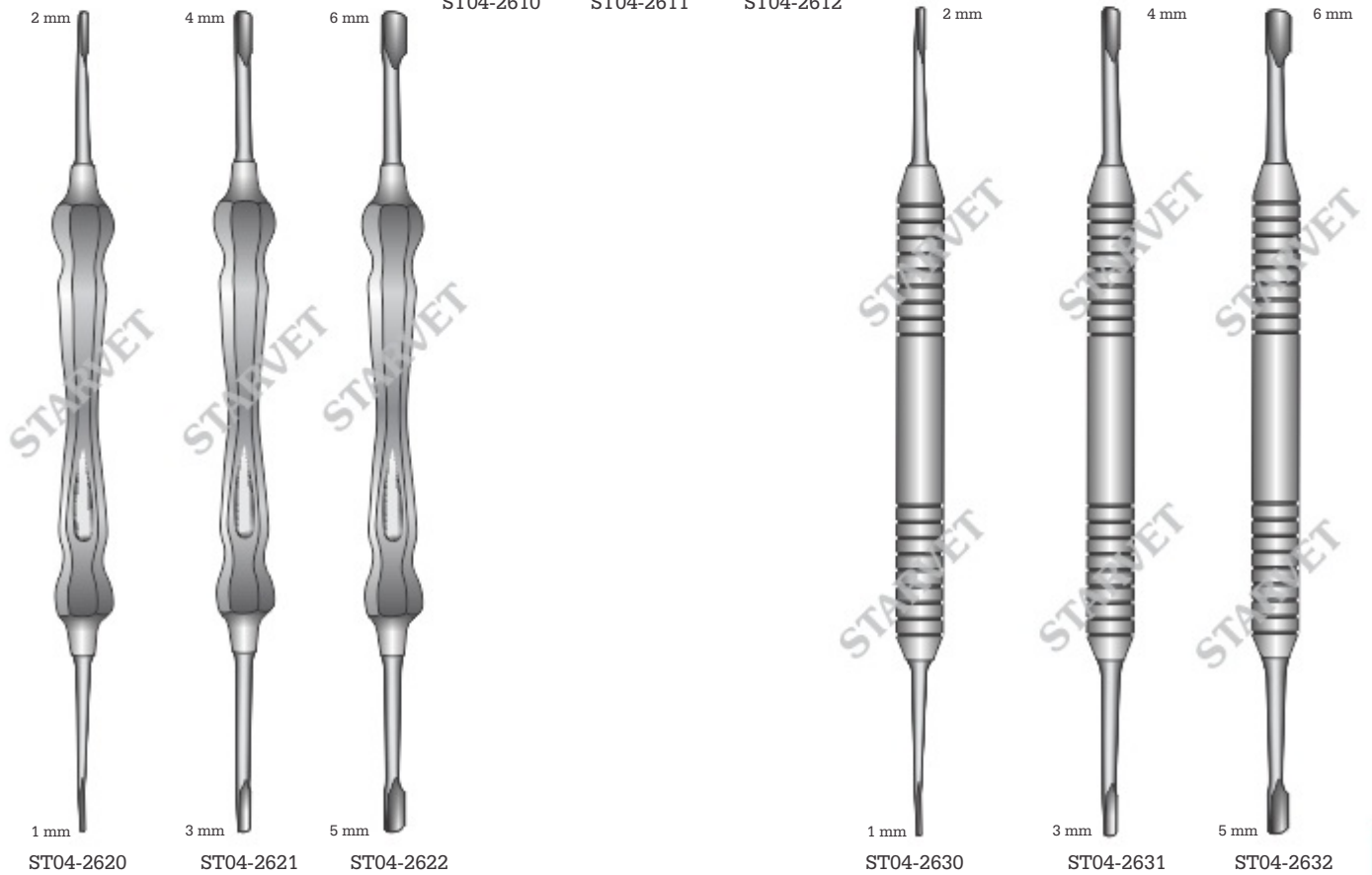



Feline Elevator  
ST04-2640  
Small



Feline Elevator  
ST04-2650  
Small



Feline Elevator  
ST04-2660  
Small



Feline Elevator  
ST04-2670  
Small



Feline Elevator  
ST04-2680  
Small



Feline Elevator  
ST04-2690  
Small

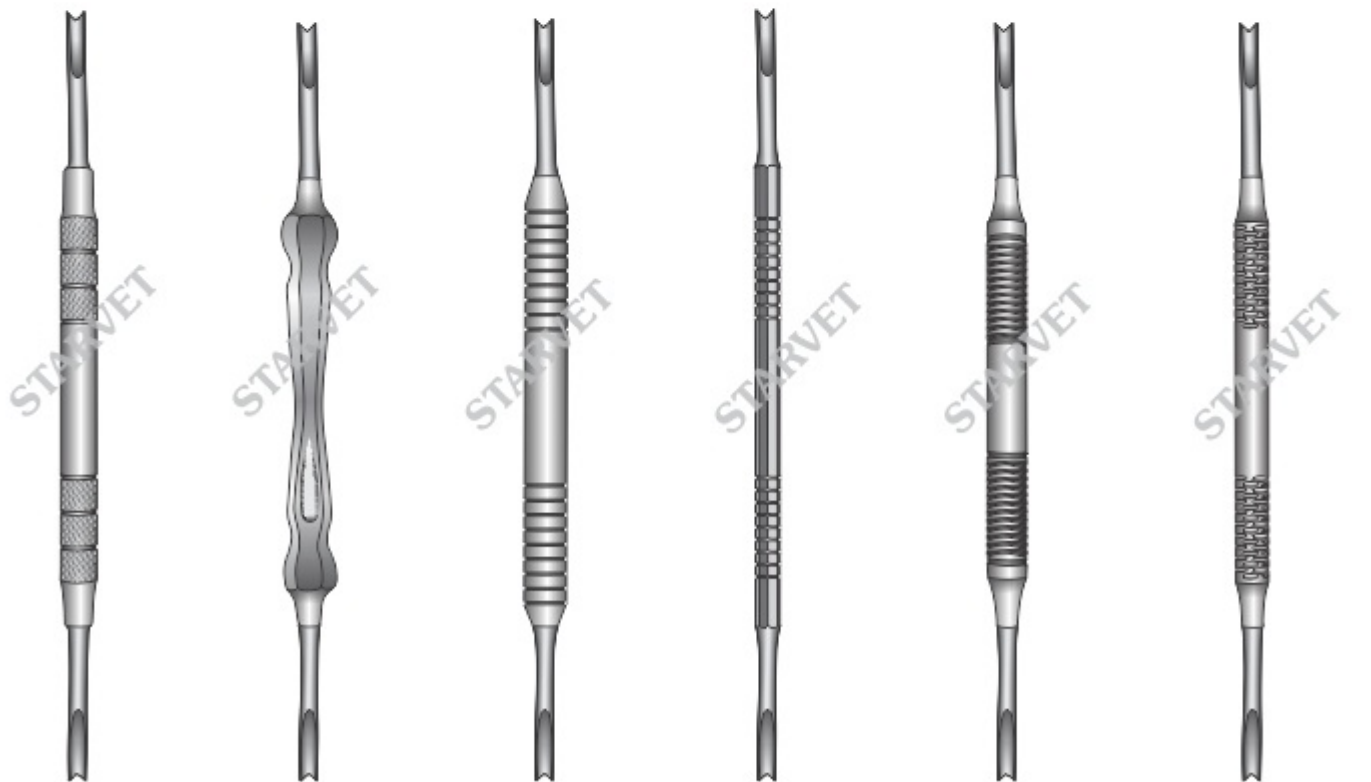
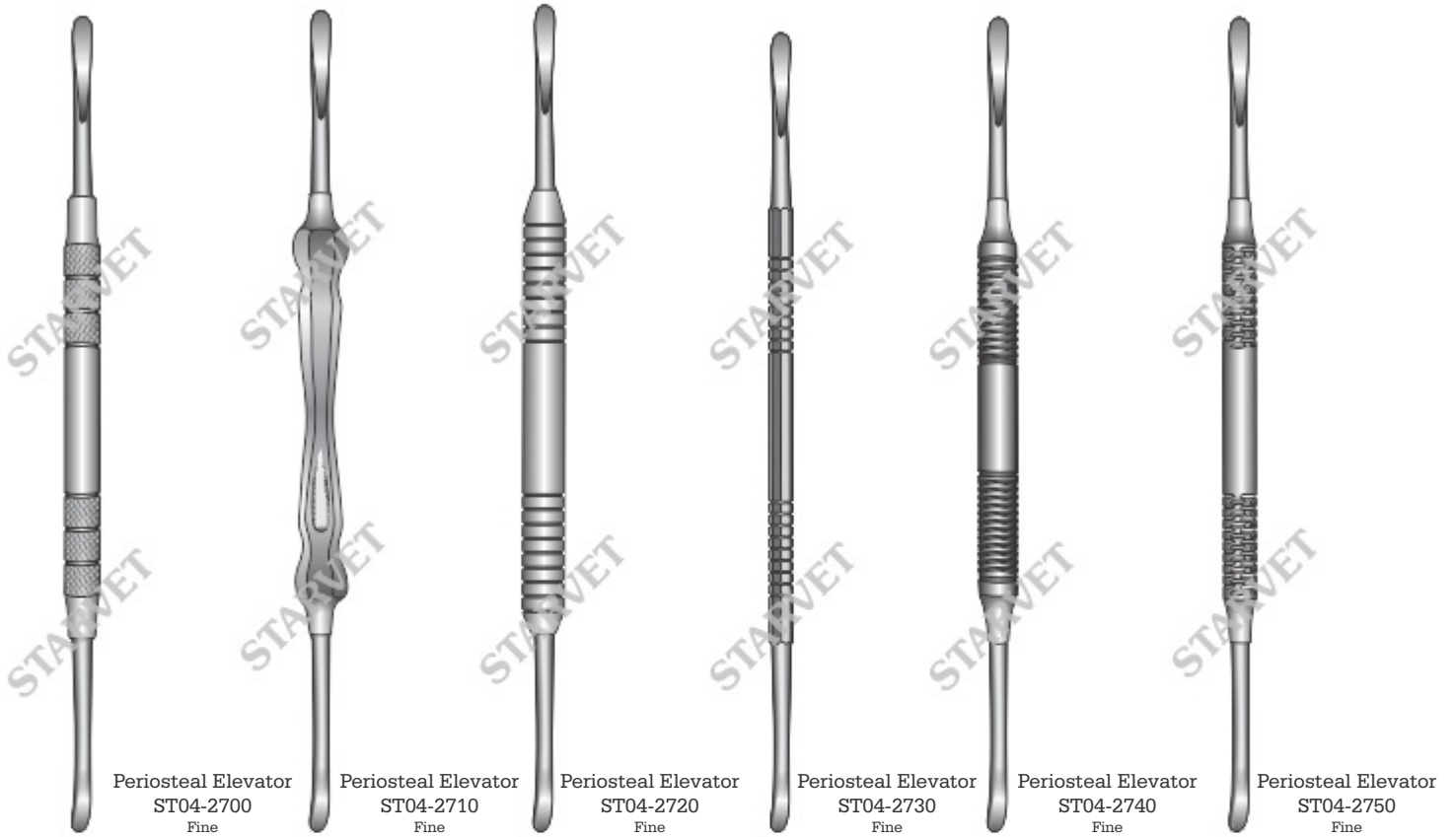



ST04-2820 2 / 2 mm  
ST04-2821 3 / 3 mm  
ST04-2822 4 / 4 mm

ST04-2830 2 / 2 mm  
ST04-2831 3 / 3 mm  
ST04-2832 4 / 4 mm

ST04-2840 2 / 2 mm  
ST04-2841 3 / 3 mm  
ST04-2842 4 / 4 mm

ST04-2850 2 / 2 mm  
ST04-2851 3 / 3 mm  
ST04-2852 4 / 4 mm

ST04-2860 2 / 2 mm  
ST04-2861 3 / 3 mm  
ST04-2862 4 / 4 mm

ST04-2870 2 / 2 mm  
ST04-2871 3 / 3 mm  
ST04-2872 4 / 4 mm



ST04-2880 2 / 2 mm  
ST04-2881 3 / 3 mm  
ST04-2882 4 / 4 mm

ST04-2890 2 / 2 mm  
ST04-2891 3 / 3 mm  
ST04-2892 4 / 4 mm

ST04-2900 2 / 2 mm  
ST04-2901 3 / 3 mm  
ST04-2902 4 / 4 mm

ST04-2910 2 / 2 mm  
ST04-2911 3 / 3 mm  
ST04-2912 4 / 4 mm

ST04-2920 2 / 2 mm  
ST04-2921 3 / 3 mm  
ST04-2922 4 / 4 mm

ST04-2930 2 / 2 mm  
ST04-2931 3 / 3 mm  
ST04-2932 4 / 4 mm

Periosteal Elevator-No 9



Periosteal Elevator  
ST04-2940  
Fig. 9

Periosteal Elevator  
ST04-2950  
Fig. 9

Periosteal Elevator  
ST04-2960  
Fig. 9

Periosteal Elevator  
ST04-2970  
Fig. 9

Periosteal Elevator  
ST04-2980  
Fig. 9

Periosteal Elevator  
ST04-2990  
Fig. 9



ST04-3000 2 / 3 mm  
ST04-3001 4 / 6 mm

ST04-3010 2 / 3 mm  
ST04-3011 4 / 6 mm

ST04-3020 2 / 3 mm  
ST04-3021 4 / 6 mm

ST04-3030 2 / 3 mm  
ST04-3031 4 / 6 mm

ST04-3040 2 / 3 mm  
ST04-3041 4 / 6 mm

ST04-3050 2 / 3 mm  
ST04-3051 4 / 6 mm





ST04-3060



ST04-3070



ST04-3080



ST04-3090



ST04-3100



ST04-3110 6 mm  
ST04-3111 7 mm  
ST04-3112 8 mm

1 mm

2 mm

3 mm

4 mm

5 mm

6 mm



ST04-3120



ST04-3130



ST04-3140



ST04-3150



ST04-3160



ST04-3170 6 mm  
ST04-3171 7 mm  
ST04-3172 8 mm

1 mm



ST04-3180  
Indigo

2 mm



ST04-3190  
Gold

3 mm



ST04-3200  
Blue

4 mm



ST04-3210  
Black

5 mm



ST04-3220  
Pink

6 mm



ST04-3230  
Green

1 mm



ST04-3240

2 mm



ST04-3250

3 mm



ST04-3260

4 mm



ST04-3270

5 mm



ST04-3280

6 mm



ST04-3290



ST04-3300



ST04-3301



ST04-3302



ST04-3303



ST04-3304



ST04-3305

1 mm

2 mm

3 mm

4 mm

5 mm

6 mm



ST04-3330



ST04-3331



ST04-3332



ST04-3333



ST04-3334



ST04-3335

1 mm



ST04-3360 Straight  
ST04-3361 Curved  
11.5 cm / 4½"

2 mm



ST04-3370 Straight  
ST04-3371 Curved  
11.5 cm / 4½"

3 mm



ST04-3380 Straight  
ST04-3381 Curved  
11.5 cm / 4½"

4 mm



ST04-3390 Straight  
ST04-3391 Curved  
11.5 cm / 4½"

5 mm



ST04-3400 Straight  
ST04-3401 Curved  
11.5 cm / 4½"

6 mm



ST04-3410 Straight  
ST04-3411 Curved  
11.5 cm / 4½"

1 mm



ST04-3420 Straight  
ST04-3421 Curved

2 mm



ST04-3430 Straight  
ST04-3431 Curved

3 mm



ST04-3440 Straight  
ST04-3441 Curved

4 mm



ST04-3450 Straight  
ST04-3451 Curved

5 mm



ST04-3460 Straight  
ST04-3461 Curved

6 mm



ST04-3470 Straight  
ST04-3471 Curved

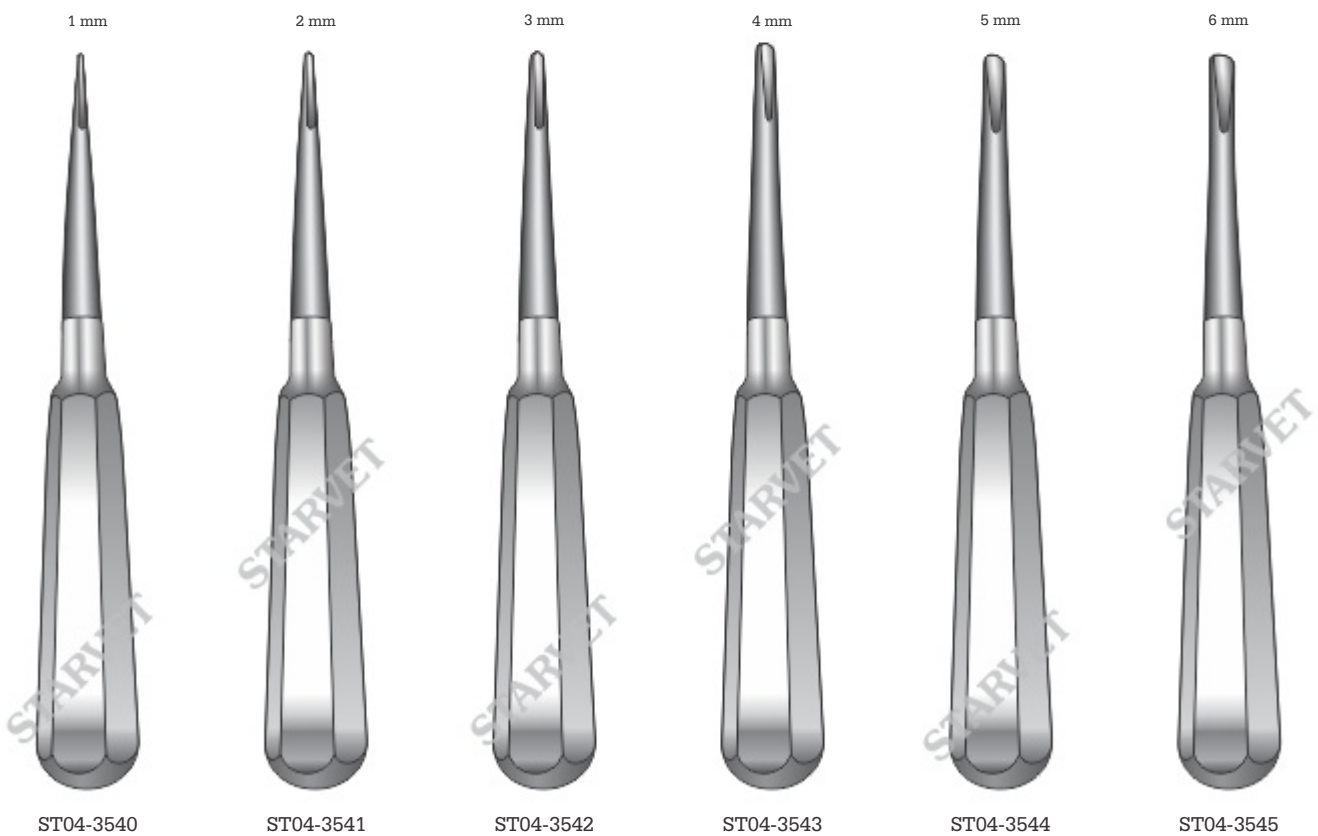
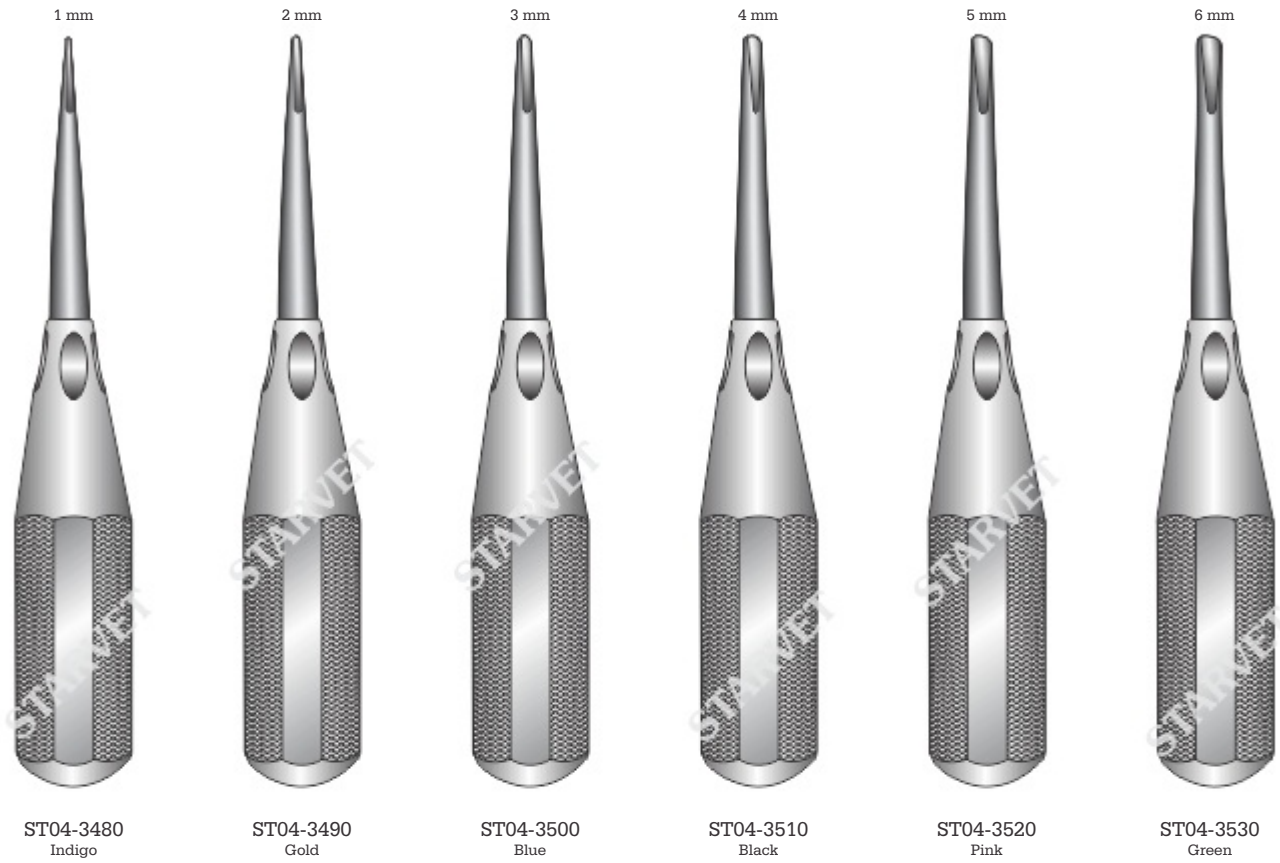

1 mm



ST04-3560

2 mm



ST04-3561

3 mm



ST04-3562

4 mm



ST04-3563

5 mm



ST04-3564

6 mm



ST04-3565

1 mm



ST04-3750

2 mm



ST04-3760

3 mm



ST04-3770

4 mm



ST04-3780

5 mm



ST04-3790

6 mm



ST04-3800



Colored Luxators  
Straight

Size	Black	Blue	White	Green	Yellow
1 mm	ST04-3810	ST04-3811	ST04-3812	ST04-3813	ST04-3814
2 mm	ST04-3820	ST04-3821	ST04-3822	ST04-3823	ST04-3824
3 mm	ST04-3830	ST04-3831	ST04-3832	ST04-3833	ST04-3834
4 mm	ST04-3840	ST04-3841	ST04-3842	ST04-3843	ST04-3844
5 mm	ST04-3850	ST04-3851	ST04-3852	ST04-3853	ST04-3854
3 mm Contra Angled	ST04-3860	ST04-3861	ST04-3862	ST04-3863	ST04-3864

Colored Luxators  
Curved

Size	Black	Blue	White	Green	Yellow
1 mm	ST04-3870	ST04-3871	ST04-3872	ST04-3873	ST04-3874
2 mm	ST04-3880	ST04-3881	ST04-3882	ST04-3883	ST04-3884
3 mm	ST04-3890	ST04-3891	ST04-3892	ST04-3893	ST04-3894
4 mm	ST04-3900	ST04-3901	ST04-3902	ST04-3903	ST04-3904
5 mm	ST04-3910	ST04-3911	ST04-3912	ST04-3913	ST04-3914



1 mm



ST04-3920

2 mm



ST04-3925

3 mm



ST04-3930

4 mm



ST04-3935

5 mm



ST04-3940

6 mm



ST04-3950

1 mm



ST04-3960

2 mm



ST04-3970

3 mm



ST04-3980

4 mm



ST04-3990

5 mm



ST04-4000

6 mm



ST04-4010

1 mm



ST04-4020

2 mm



ST04-4030

3 mm



ST04-4040

4 mm



ST04-4050

5 mm

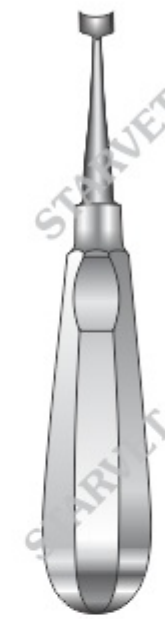

ST04-4060

6 mm

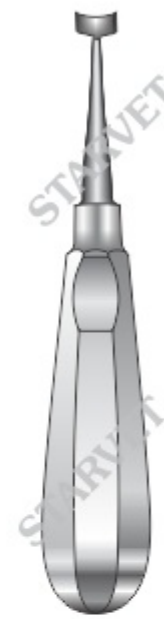

ST04-4070

1 mm



ST04-4080

2 mm



ST04-4090

3 mm



ST04-4100

4 mm



ST04-4110

5 mm



ST04-4120

6 mm



ST04-4130

1 mm



ST04-4140

2 mm



ST04-4150

3 mm



ST04-4160

4 mm



ST04-4170

5 mm



ST04-4180

6 mm



ST04-4190

1 mm



ST04-4200

2 mm



ST04-4210

3 mm



ST04-4220

4 mm



ST04-4230

5 mm



ST04-4240

6 mm



ST04-4250

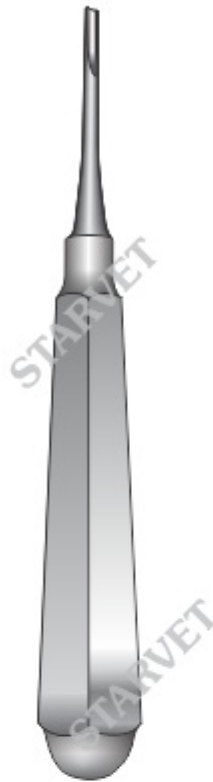

**Coupland**  
ST04-4260 3 mm  
ST04-4261 4 mm  
ST04-4262 5 mm  
15 cm / 6"  
Straight Tip

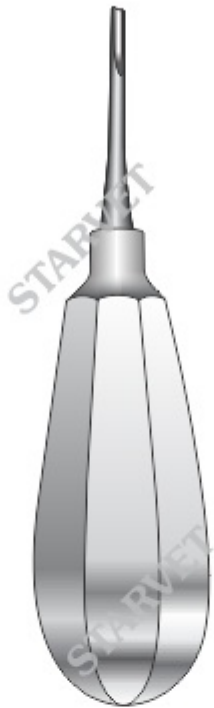

**Coupland**  
ST04-4270 3 mm  
ST04-4271 4 mm  
ST04-4272 5 mm  
15 cm / 6"  
Straight Tip

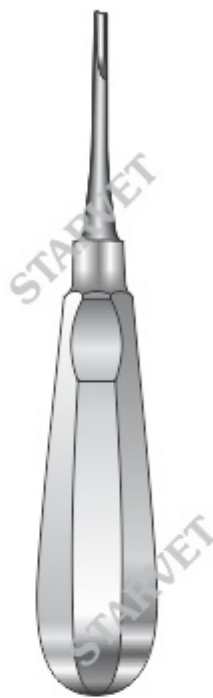

**Couplands**  
ST04-4280 3 mm  
ST04-4281 4 mm  
ST04-4282 5 mm  
15 cm / 6"  
Straight Tip

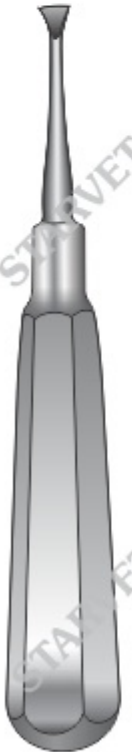

**Periosteal Elevator**  
ST04-4290 6 mm  
ST04-4291 8 mm

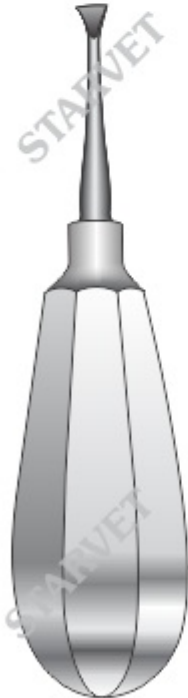

**Periosteal Elevator**  
ST04-4300 6 mm  
ST04-4301 8 mm

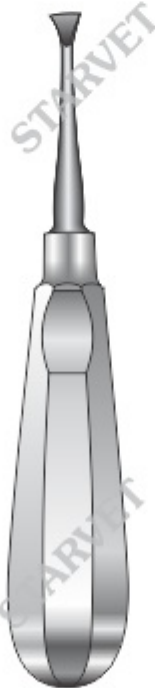

**Periosteal Elevator**  
ST04-4310 6 mm  
ST04-4311 8 mm

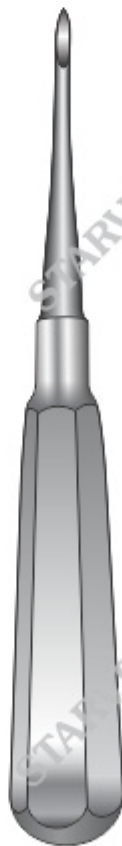

**Root Tip Pick**  
ST04-4320  
Straight



**Root Tip Pick**  
ST04-4330  
Straight



**Root Tip Pick**  
ST04-4340  
Straight

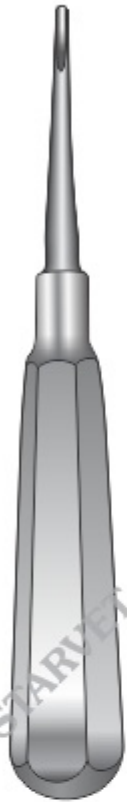

**Carnivore**  
ST04-4350 2.5 mm  
ST04-4351 3.5 mm  
ST04-4352 4.0 mm  
15 cm / 6"

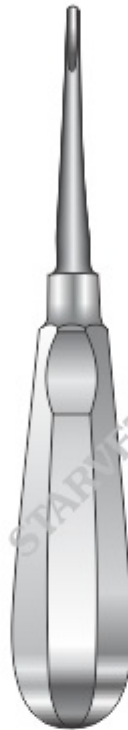

**Carnivore**  
ST04-4360 2.5 mm  
ST04-4361 3.5 mm  
ST04-4362 4.0 mm  
15 cm / 6"

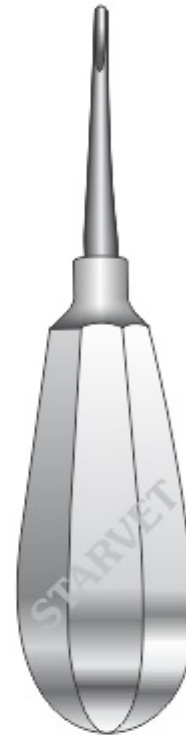

**Carnivore**  
ST04-4370 2.5 mm  
ST04-4371 3.5 mm  
ST04-4372 4.0 mm  
15 cm / 6"



**Coupland**  
ST04-4380 2 mm  
ST04-4381 2.5 mm  
ST04-4382 3 mm  
ST04-4383 4 mm  
ST04-4384 5 mm  
15 cm / 6"

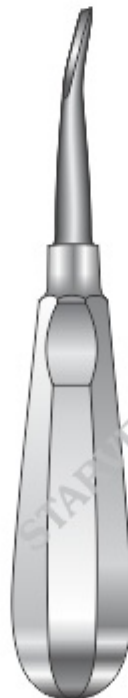

**Coupland**  
ST04-4390 2 mm  
ST04-4391 2.5 mm  
ST04-4392 3 mm  
ST04-4393 4 mm  
ST04-4394 5 mm  
15 cm / 6"



**Coupland**  
ST04-4400 2 mm  
ST04-4401 2.5 mm  
ST04-4402 3 mm  
ST04-4403 4 mm  
ST04-4404 5 mm  
15 cm / 6"

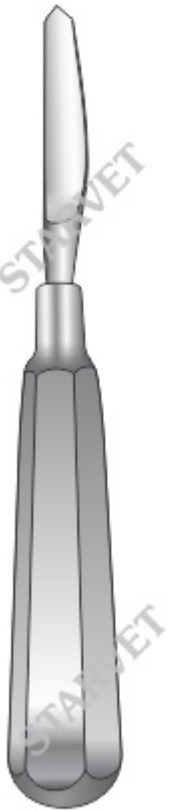

ST04-4410



ST04-4420

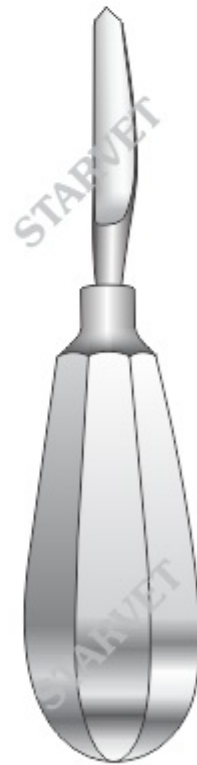

ST04-4430



ST04-4440  
2 mm  
Super Fine

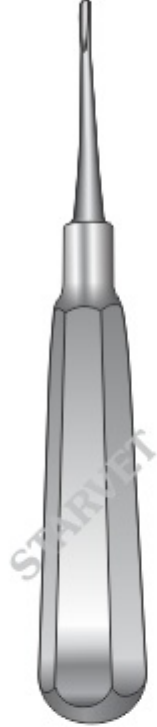

ST04-4450 2 mm  
ST04-4451 3 mm  
ST04-4452 4 mm  
ST04-4453 5 mm  
ST04-4454 6 mm  
Super Fine



ST04-4460 2 mm  
ST04-4461 3 mm  
ST04-4462 4 mm  
ST04-4463 5 mm  
ST04-4464 6 mm  
Super Fine



ST04-4470 2 mm  
ST04-4471 3 mm  
ST04-4472 4 mm  
ST04-4473 5 mm  
ST04-4474 6 mm  
Super Fine



ST04-4480 2 mm  
ST04-4481 3 mm  
ST04-4482 4 mm  
ST04-4483 5 mm  
ST04-4484 6 mm  
Super Fine

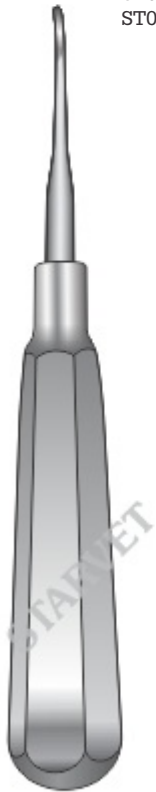

ST04-4490 2 mm  
ST04-4491 3 mm  
ST04-4492 4 mm  
ST04-4493 5 mm  
ST04-4494 6 mm  
Super Fine

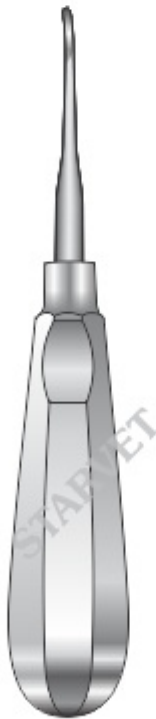

ST04-4500 2 mm  
ST04-4501 3 mm  
ST04-4502 4 mm  
ST04-4503 5 mm  
ST04-4504 6 mm  
Super Fine



ST04-4510 2 mm  
ST04-4511 3 mm  
ST04-4512 4 mm  
ST04-4513 5 mm  
ST04-4514 6 mm  
Super Fine



ST04-4520 2 mm  
ST04-4521 3 mm  
ST04-4522 4 mm  
ST04-4523 5 mm  
ST04-4524 6 mm  
Super Fine

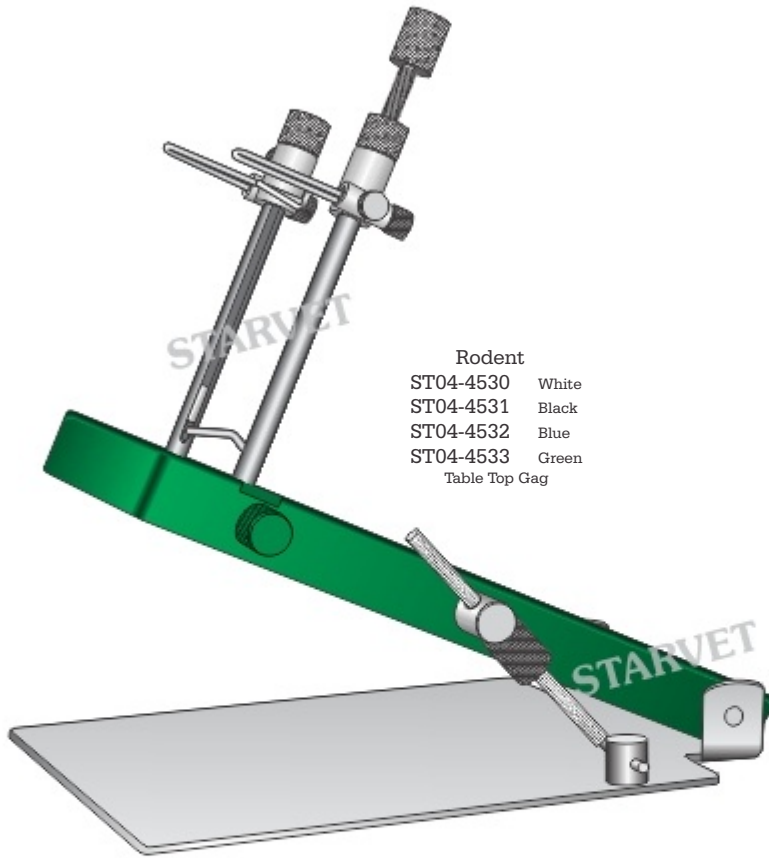

Rodent  
ST04-4530 White  
ST04-4531 Black  
ST04-4532 Blue  
ST04-4533 Green  
Table Top Gag

L.E.D  
Light Clamp  
ST04-4545

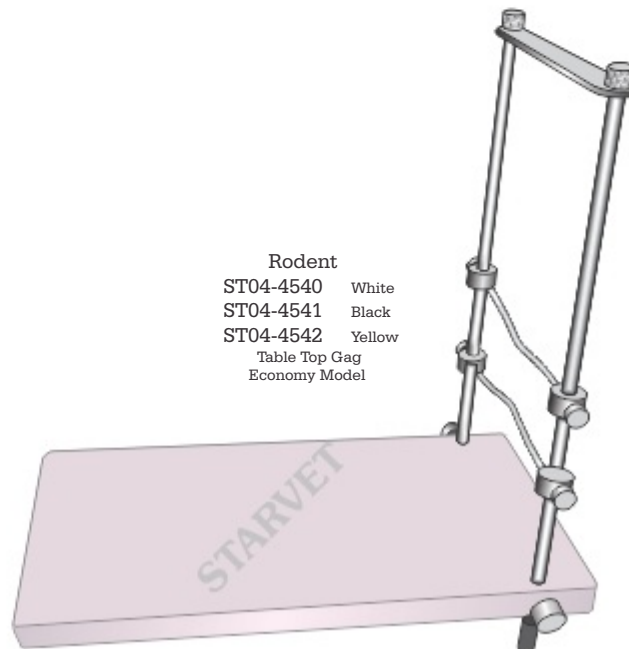

Rodent  
ST04-4540 White  
ST04-4541 Black  
ST04-4542 Yellow  
Table Top Gag  
Economy Model





ST04-4550



ST04-4560



ST04-4570



ST04-4580



Wire Mouth Gag  
ST04-4590



ST04-4595



Mouth Gag  
ST04-4600



Mouth Gag  
ST04-4610 Small  
ST04-4611 Large  
Light Weight



Cheek Dilators  
ST04-4620 X Small  
ST04-4621 Small  
ST04-4622 Medium  
ST04-4623 Large



ST04-4630 Small  
ST04-4631 Large



Cheek Dilators  
ST04-4640 Small  
ST04-4641 Medium  
ST04-4642 Large  
Curved



ST04-4650 Small  
ST04-4651 Medium  
ST04-4652 Large



ST04-4660 Small  
ST04-4661 Medium  
ST04-4662 Large



ST04-4670 30 mm  
ST04-4671 40 mm  
ST04-4672 50 mm  
ST04-4673 60 mm



ST04-4680 30 mm  
ST04-4681 40 mm  
ST04-4682 50 mm  
ST04-4683 60 mm  
ST04-4684 70 mm



Rodent Rasps  
ST04-4690  
Narrow



Rodent Rasps  
ST04-4700  
Medium



Rodent Rasps  
ST04-4710  
Wide



Rodent Spatula  
ST04-4720



Rodent Spatula  
ST04-4730



Rodent Spatula  
ST04-4740 Small  
ST04-4741 Large



Molar Luxator  
ST04-4750



Molar Luxator  
ST04-4760



Molar Luxator  
ST04-4770



Molar Luxator  
ST04-4780



Molar Luxator  
ST04-4790



Molar Luxator  
ST04-4800



Crossley Luxator  
ST04-4810  
Small



Crossley Luxator  
ST04-4820  
Small



Crossley Luxator  
ST04-4830  
Small



Crossley Luxator  
ST04-4840  
Small



Crossley Luxator  
ST04-4850  
Small



Crossley Luxator  
ST04-4860  
Small



Crossley Luxator  
ST04-4870



Crossley Luxator  
ST04-4880



Crossley Luxator  
ST04-4890



Crossley Luxator  
ST04-4900



Crossley Luxator  
ST04-4910



Crossley Luxator  
ST04-4920



ST04-4930



ST04-4940



ST04-4950



ST04-4960



ST04-4970



ST04-4980



ST04-4990



ST04-5000



ST04-5010



ST04-5020



ST04-5030



ST04-5040



Molar Extraction Forceps  
ST04-5050



Molar Cutter  
ST04-5060 Small  
ST04-5061 Large



Molar Cutter  
ST04-5070 Small  
ST04-5071 Large



Molar Cutter  
ST04-5080 Small  
ST04-5081 Large



Molar Cutter  
ST04-5090 Small  
ST04-5091 Large  
14 cm / 5½"  
TC



Root Fragment Forceps  
ST04-5100



Bur Holder  
ST04-5110

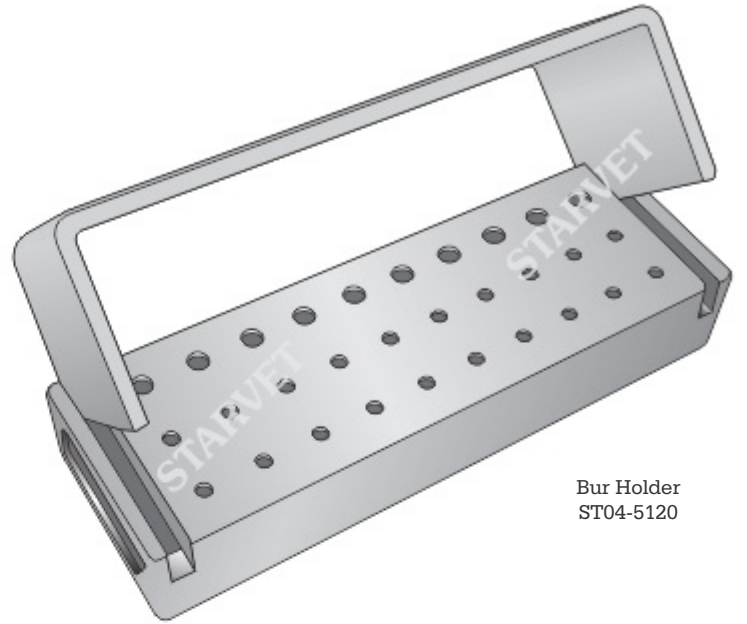

Bur Holder  
ST04-5120



Sharpening Stone  
ST04-5130



Tissue Protector  
ST04-5140



Safety Shield  
ST04-5150

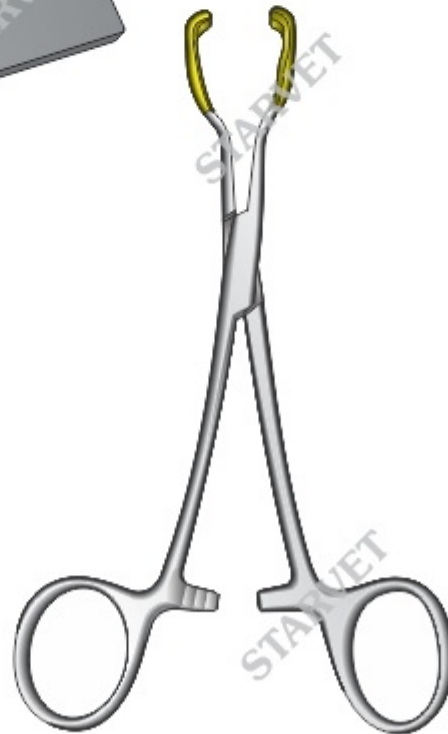

Lip Retractor  
ST04-5160  
16 mm



Minnesota Retractor  
ST04-5170





Rabbit Lachrymal Duct Cannula

- ST04-5180 19 Gauge
- ST04-5181 21 Gauge
- ST04-5182 Set of 2



Oral Dosing Needles

- ST04-5190 12 Gauge, 200 mm, Curved
- ST04-5191 14 Gauge, 125 mm, Curved
- ST04-5192 16 Gauge, 75 mm, Straight
- ST04-5193 16 Gauge, 75 mm, Curved
- ST04-5194 16 Gauge, 100 mm, Straight
- ST04-5195 18 Gauge, 50 mm, Straight
- ST04-5196 18 Gauge, 50 mm, Curved
- ST04-5197 20 Gauge, 38 mm, Straight
- ST04-5198 20 Gauge, 38 mm, Curved
- ST04-5199 20 Gauge, 25 mm, Curved
- ST04-5200 20 Gauge, 25 mm, Straight
- ST04-5201 22 Gauge, 38 mm, Straight
- ST04-5202 22 Gauge, 38 mm, Curved
- ST04-5203 23 Gauge, 25 mm, Straight



Spreulls Needle

- ST04-5210 Short, 60 mm
  - ST04-5211 Long, 100 mm
- Ear Flushing Needles



Flushing Needles

- ST04-5220 Bead Tip 30 mm
  - ST04-5221 Bead Tip 50 mm
  - ST04-5222 Bead Tip 70 mm
- 21 Gauge



- ST04-5230 2 mm
- ST04-5231 3 mm
- ST04-5232 4 mm
- ST04-5233 5 mm
- ST04-5234 6 mm

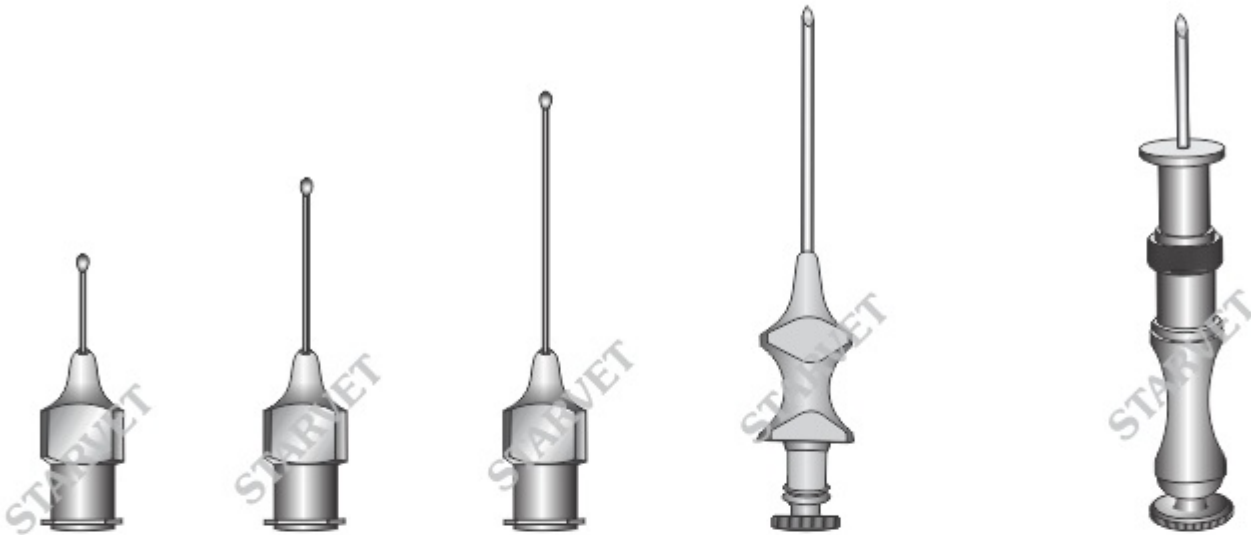

Urethral Catheters

ST04-5240  
Length ½"  
Gauge 22  
Tip Size 1.4 mm

Urethral Catheters

ST04-5250  
Length 1"  
Gauge 22  
Tip Size 1.4 mm

Urethral Catheters

ST04-5260  
Length 1½"  
Gauge 22  
Tip Size 1.4 mm

ST04-5270

Bone Marrow Biopsy - Klima Type

ST04-5280 18 gauge, 25 mm  
ST04-5281 16 gauge, 25 mm  
ST04-5282 16 gauge, 37 mm  
ST04-5283 22 gauge, 25 mm



**Spinal Needle**  
ST04-5290 21 gauge, 40 mm  
ST04-5291 21 gauge, 25 mm  
ST04-5292 19 gauge, 38 mm  
Short Bevel, Reusable



**Bone Marrow Biopsy Needles**  
ST04-5300 18 gauge  
ST04-5301 13 gauge  
ST04-5302 11 gauge, 100 mm  
ST04-5303 8 gauge, 100 mm  
Re Useable



**Bladder Catheters**  
ST04-5310 Straight (Queen), 170 mm  
ST04-5311 Curved (Bitch), 180 mm  
ST04-5312 Curved (Bitch), 250 mm  
ST04-5313 Curved (Bitch), 300 mm

**Special  
Mouth Gag**  
Ask for  
Details

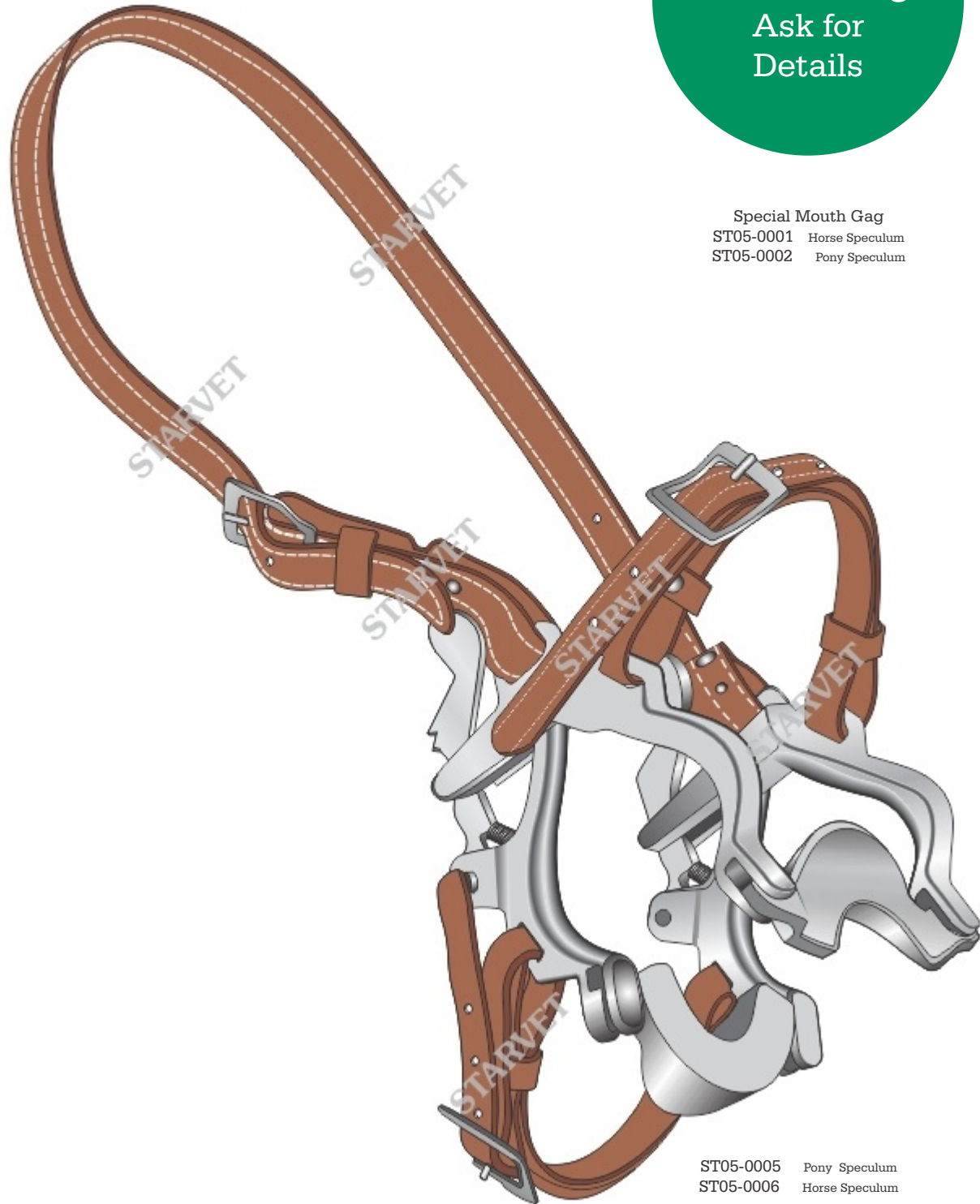

Special Mouth Gag  
ST05-0001 Horse Speculum  
ST05-0002 Pony Speculum

ST05-0005 Pony Speculum  
ST05-0006 Horse Speculum

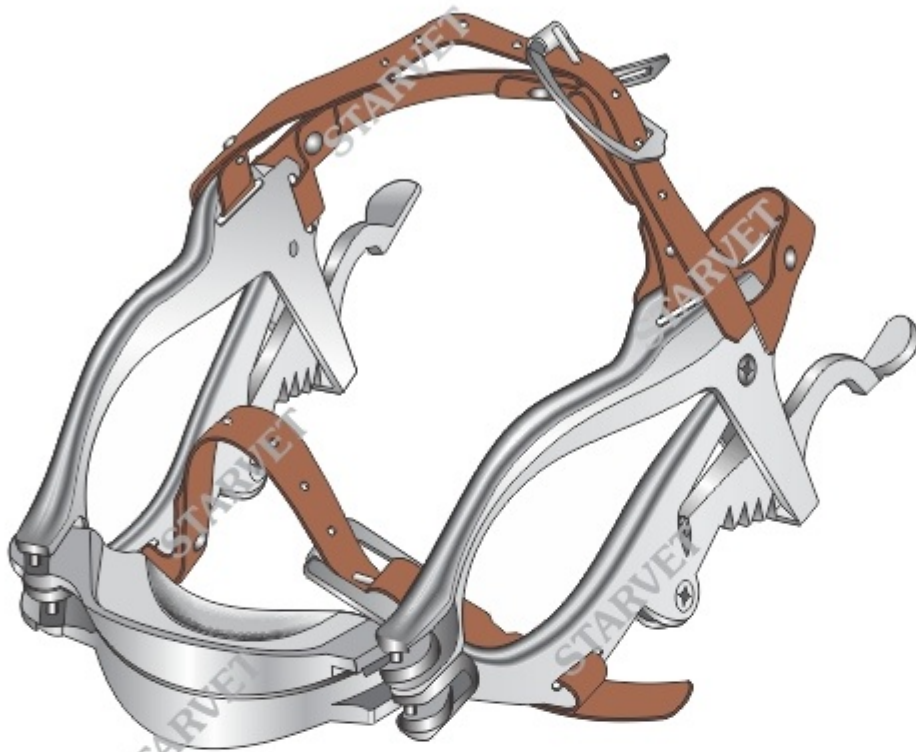

Haussmann / Climax  
ST05-0010  
with leather straps  
stainless steel forged  
ST05-0011

Haussmann / Climax  
Pony With Biothene Straps

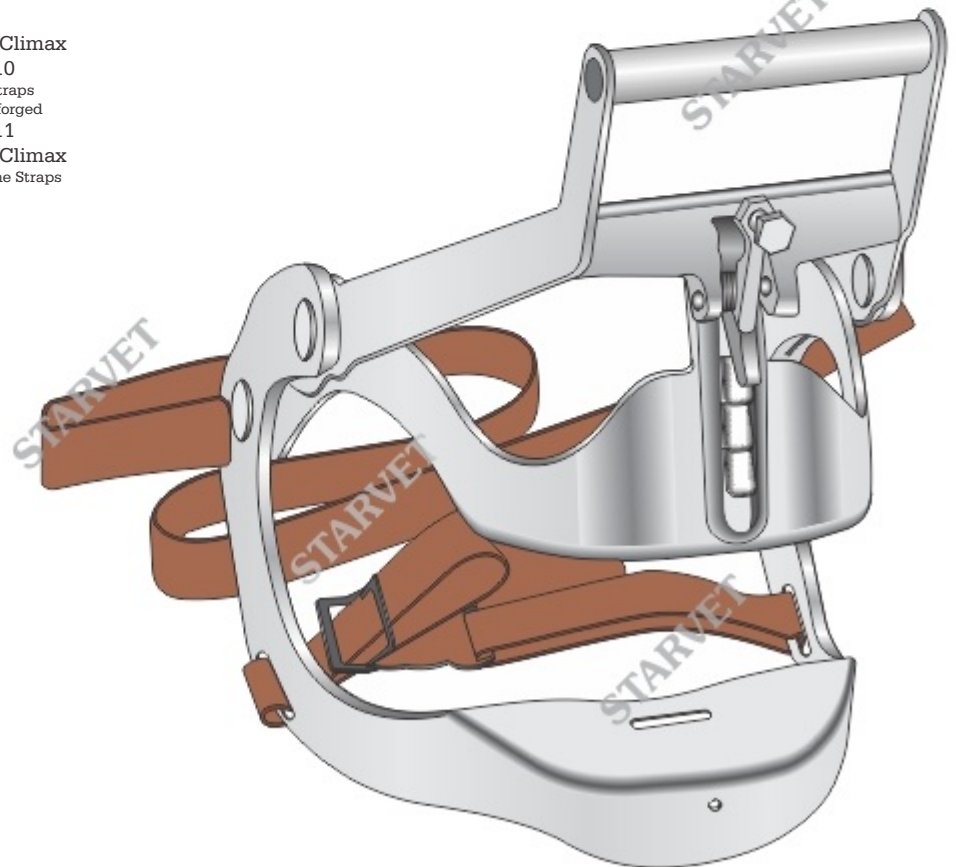

ST05-0020  
Mondspeder paard RVS DeLuxe

## Spare Kits

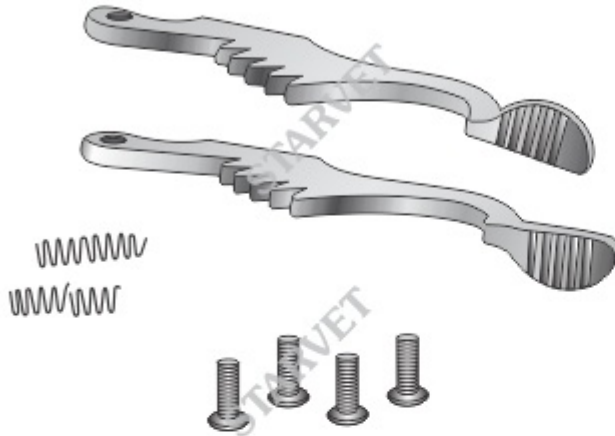

Spare Part Kit  
For  
Climax Speculum  
ST-05-0030  
Consists of 2 ratchets, springs and screws.



Replacement Biothane Straps  
For  
Climax Speculum  
ST-05-0040  
Replacement Biothane straps for Climax Speculum  
Complete set of replacement straps incl. screws for fixation.



Replacement Biothane Straps  
For  
Meister Speculum  
ST-05-0050  
Replacement Biothane straps for Meister Speculum  
Complete set of replacement straps incl. screws for fixation.

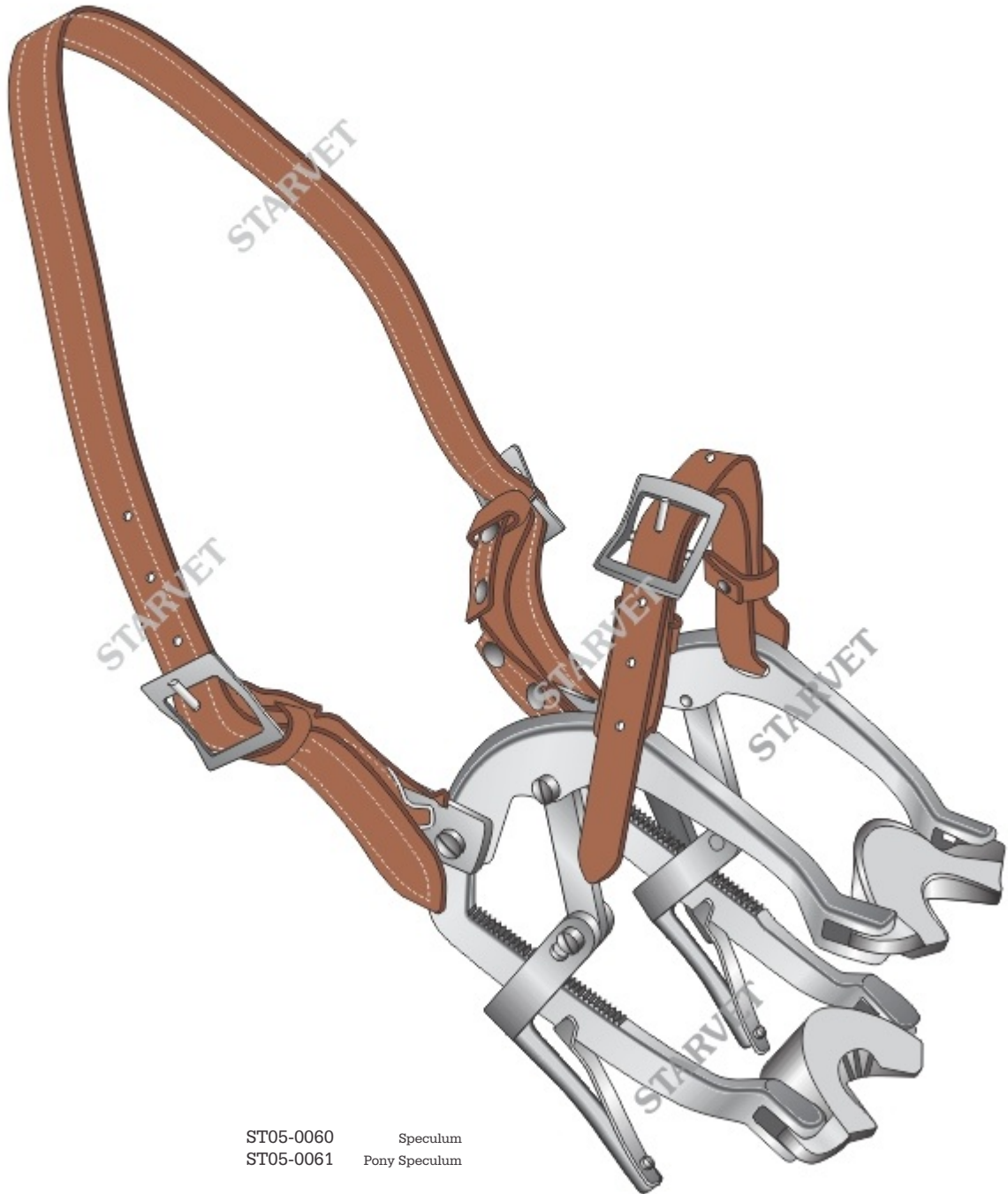

ST05-0060 Speculum  
ST05-0061 Pony Speculum

Special Plates  
ST05-0070  
Pair



ST05-0080  
Pair



ST05-0090  
Pair

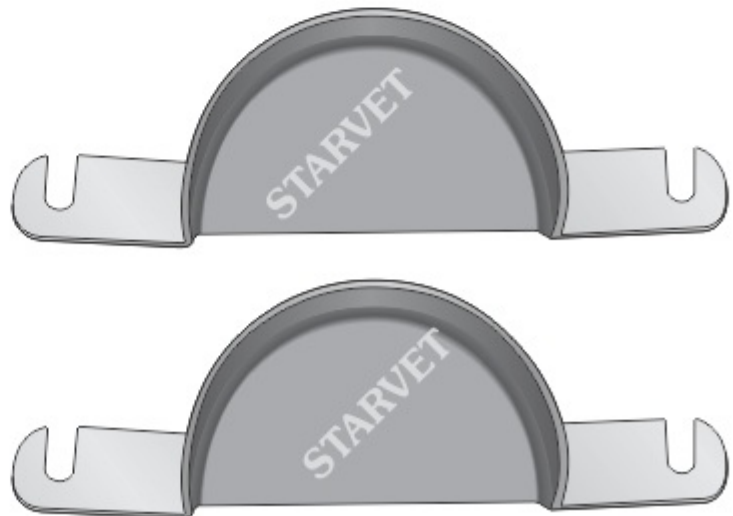

ST05-0100  
Pair

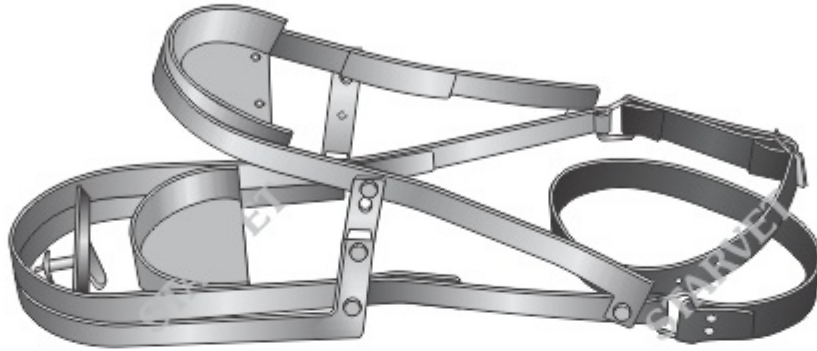

Mouth Gag  
ST05-0110  
Swedish Pattern  
with leather straps

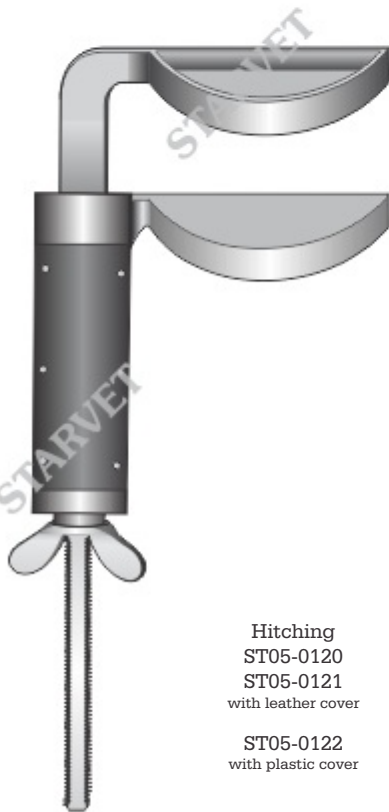

Hitching  
ST05-0120  
ST05-0121  
with leather cover  
  
ST05-0122  
with plastic cover

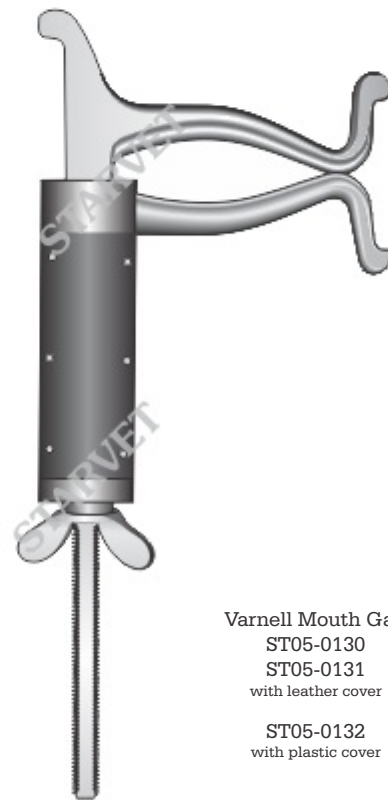

Varnell Mouth Gag  
ST05-0130  
ST05-0131  
with leather cover  
  
ST05-0132  
with plastic cover



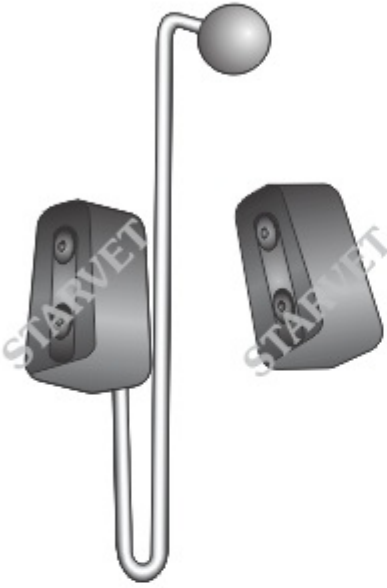

ST05-0140



ST05-0150



Schoope  
ST05-0160



ST05-0170  
35.5 cm / 14"

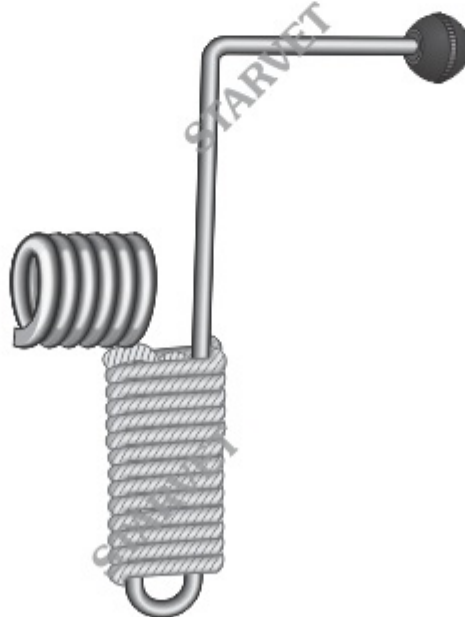

ST05-0180  
25.5 cm / 10"

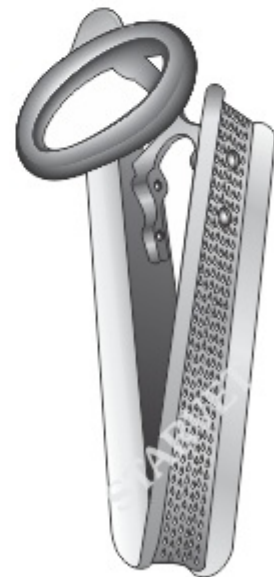

Bayer  
ST05-0190  
Mouth wedges C.P.



Gunther  
ST05-0200  
Mouth Gage for Horses

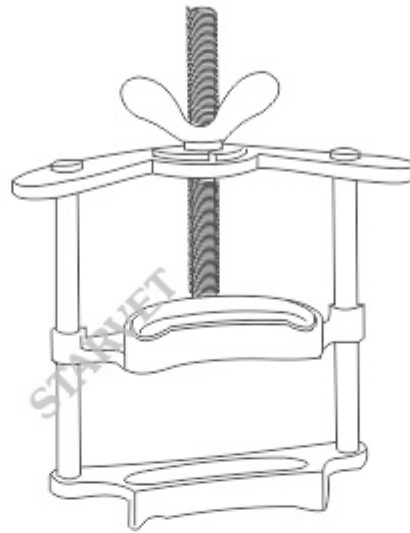

Butler  
ST05-0210  
Mouth Gags for Horses



ST05-0220  
Thumb Speculum

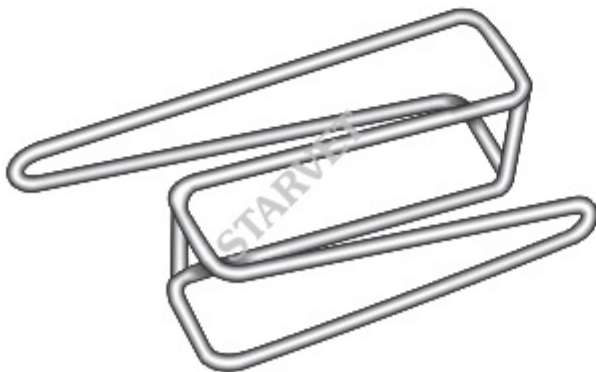

Cheek Retractor  
ST05-0230

Pulls the cheek gently away from the cheek teeth so occlusion can be evaluated on a closed mouth. Can also be used to give more room when electrical equipment is used on the cheek teeth.

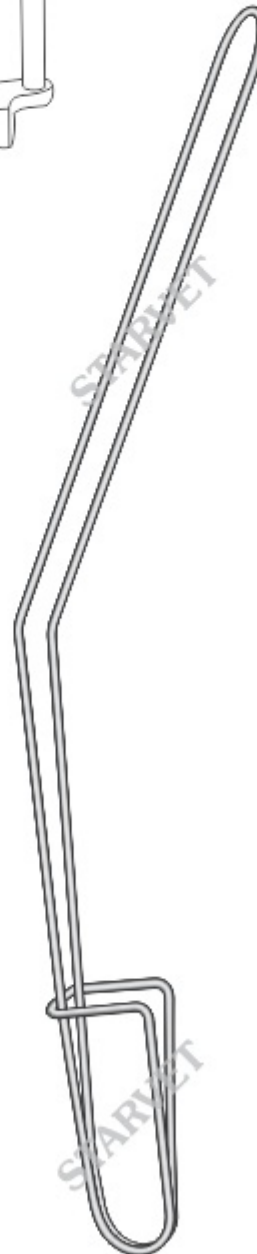

ST05-0240  
66 cm / 26"



ST05-0250  
60 cm / 23¾"



Dental Punch Set  
ST05-0260



Dental Punch Set  
ST05-0270  
20 cm / 8"  
Four angled punch for repulsion of cheek teeth  
12.5 mm offset, 20mm offset, curved and straight.



Dental Tooth Punch  
ST05-0280 Straight  
ST05-0281 Angled  
20 cm / 8"  
Serrated Heads



ST05-0290 Straight  
ST05-0291 curved



Dental Punch  
ST05-0300 12 mm Head  
ST05-0301 Fine, 8 mm Head  
ST05-0303 Set, Normal & Fine

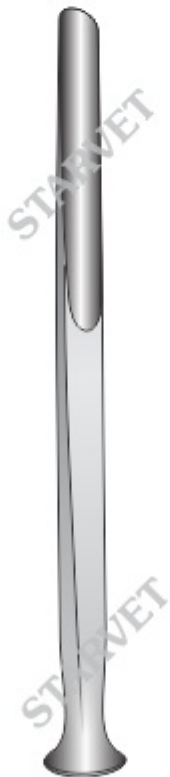
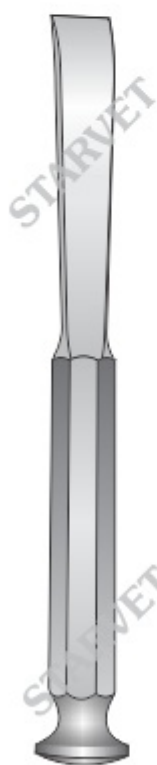
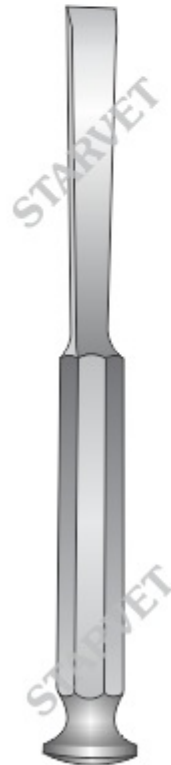

Dental Chisel  
ST05-0310  
19 cm / 7½"  
Long Blade, 12 mm / 0.5" Wide  
Straight

Dental Chisel  
ST05-0320  
19 cm / 7½"  
Long Blade, 12 mm / 0.5" Wide  
Curved

Alexander Bone Chisel  
ST05-0330 6 mm Flat  
ST05-0331 6 mm Hollow  
ST05-0332 8 mm Hollow  
ST05-0333 10 mm Hollow  
ST05-0334 12 mm Hollow  
ST05-0335 14 mm Hollow

Dental Chisels  
ST05-0340  
59.5 cm / 23½"

Dental Chisels  
ST05-0350  
59 cm / 23"

Dental Chisels  
ST05-0360  
70 cm / 27½"



Dental Tooth Elevator  
ST05-0370



Elevator  
ST05-0380 Left  
ST05-0381 Right



Dental Tooth Elevator  
ST05-0390  
Curved



Wolf Tooth Elevator  
ST05-0400  
Standard fibre handle



Wolf Tooth Elevator  
ST05-0410  
Secure grip handle



Dental Tooth Elevator  
ST05-0420



Dental Tooth Elevator  
ST05-0430

ST-05-0455



ST05-0450  
16 cm / 6¼"



ST05-0460  
16 cm / 6¼"



ST05-0470  
16.5 cm / 6½"



ST05-0480  
23 cm / 9"

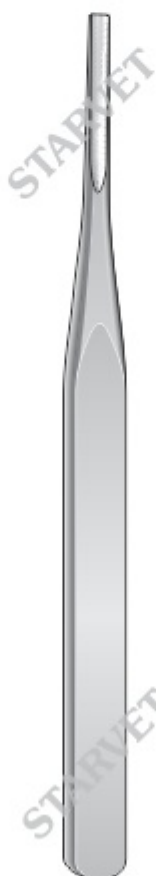

ST05-0490  
23 cm / 9"



Tooth Elevator  
ST05-0500 Right Angled  
ST05-0501 Left Angled



ST05-0510



ST05-0520



ST05-0530  
31 cm / 12 1/4"



ST05-0540  
33 cm / 13"



ST05-0550  
31.5 cm / 12 1/2"



STARVET  
STARVET  
STARVET

ST05-0560  
40.5 cm / 16"  
ST05-0561  
48 cm / 19"



STARVET  
STARVET  
STARVET

ST05-0570  
40.5 cm / 16"  
ST05-0571  
48 cm / 19"



STARVET  
STARVET  
STARVET

ST05-0580  
40.5 cm / 16"  
ST05-0581  
48 cm / 19"



STARVET  
STARVET  
STARVET

ST05-0590  
38.5 cm / 15¼"



STARVET  
STARVET  
STARVET

ST05-0600  
38.5 cm / 15¼"



STARVET  
STARVET  
STARVET

ST05-0610  
38.5 cm / 15¼"





ST05-0620  
35.5 cm / 14"



ST05-0630  
35.5 cm / 14"



ST05-0640  
35.5 cm / 14"



ST05-0650  
40.5 cm / 16"



ST05-0660  
40 cm / 15 3/4"



75 mm

STARVET

ST05-0670  
Angled  
ST05-0671  
Straight



45 mm

STARVET

ST05-0680  
Angled  
ST05-0681  
Straight



50 mm

STARVET

ST05-0690  
Angled  
ST05-0691  
Straight



50 mm

STARVET

ST05-0700  
Angled



STARVET

ST05-0710  
Angled  
ST05-0711  
Straight



25 mm

STARVET

ST05-0720  
Angled  
ST05-0721  
Straight





ST05-0810



Wolf Tooth Extractor Set (Basic)  
ST05-0820  
Burgess type in canvas bag with ergonomic handle  
Set contains;  
Handle  
Straight and cranked extension piece  
8.0 mm & 10 mm Cutting head  
T-bar for displacing tooth heads  
T-bar for tightening  
Canvas bag with pockets



Wolf tooth Extractor Set (Basic)  
ST05-0830



Wolf Tooth Extractor Set  
ST05-0840



Wolf Tooth Extractor  
with key  
ST05-0860  
8 mm inner ø, 14 mm outer ø  
ST05-0861  
10 mm inner ø, 16 mm outer ø



ST05-0870  
29.5 cm / 11¾"



25.5 cm / 10"



25 cm / 9¾"



Dental Pick Set  
ST05-0850

The set includes two handles - a short hand piece and a long T-Bar handle which fit the interchangeable heads and allow access to any area within the mouth. All heads can be rotated. All heads can be rotated. The chisel head can be used to separate the gingiva from the sides of the tooth prior to extraction. The long and short osteotome heads can be used to separate teeth or tooth fragments. The long and short elevator heads can be used in the short hand piece to aid in removal of wolf teeth or they can be used on the long handle to aid in the removal of dental root fragments from the alveolus. The loop curette is an ideal tool to snag loose tooth or root fragments from the alveolus. Chuck with short and long pins is used as dental pick for probing alveolar pockets and areas of infundibular decay as well as for removing feed and debris





Rasp  
ST05-0890

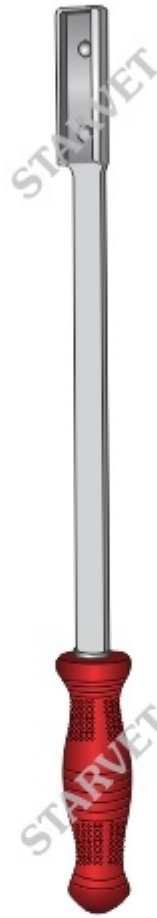

ST05-0900  
35 cm / 13 3/4"



ST05-0910  
30.5 cm / 12"

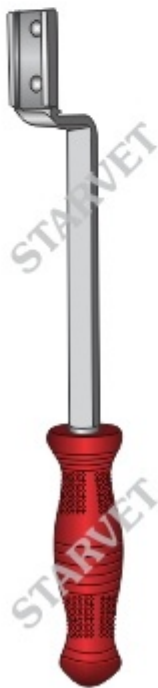

ST05-0920  
24 cm / 9 1/2"

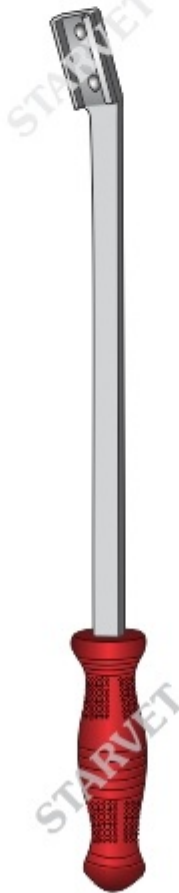

Rear Molar Float  
ST05-0930  
34 cm / 13 1/2"

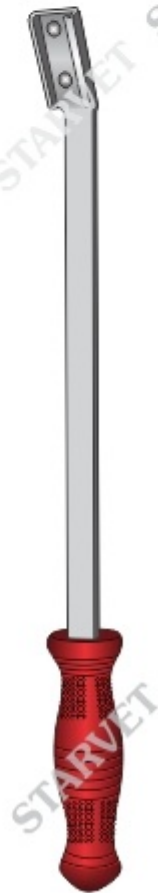

ST05-0940  
34 cm / 13 1/4"



ST05-0950  
24 cm / 9½"



ST05-0970  
37 cm / 14½"



ST05-1010  
51 cm / 20"



ST05-0980  
41 cm / 16"



ST05-1020  
53.5 cm / 21"



ST05-0990  
44 cm / 17¼"



ST05-1030  
56 cm / 22"



Key  
ST05-1110



ST05-1040  
59 cm / 23¼"

ST05-1050  
57 cm / 22½"

ST05-1060  
53.5 cm / 21"

ST05-1070  
52 cm / 20½"

ST05-1080  
51.5 cm / 20¼"

ST05-1090  
46.5 cm / 18¼"

ST05-1100  
38 cm / 15"





Universal Dental Forceps  
ST05-1120  
17 cm / 6 3/4"  
Can be used for removal of  
tartar from the canine. Length



ST05-1130



ST05-1140



ST05-1150  
29 cm / 11 1/2"



ST05-1160  
20 cm / 8"



ST05-1170  
24 cm / 9 1/2"



ST05-1180  
29.5 cm / 11 1/2"



Tooth Forceps  
ST05-1190  
17 cm / 6 3/4"  
For Wolf Teeth - Fine, Closed

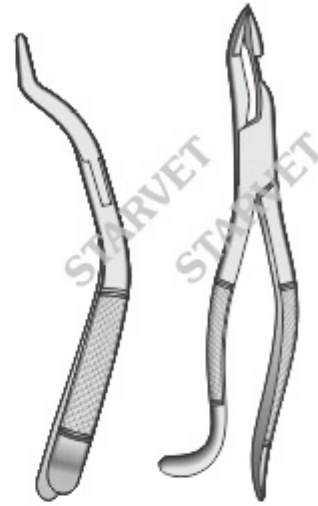

Tooth Forceps  
ST05-1200  
25 cm / 10"  
Tooth forceps for wolf teeth,  
box joint, fully angled jaws, fully closed

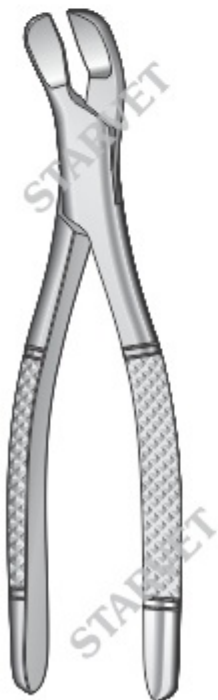

ST05-1210  
22.5 cm / 8 3/4"

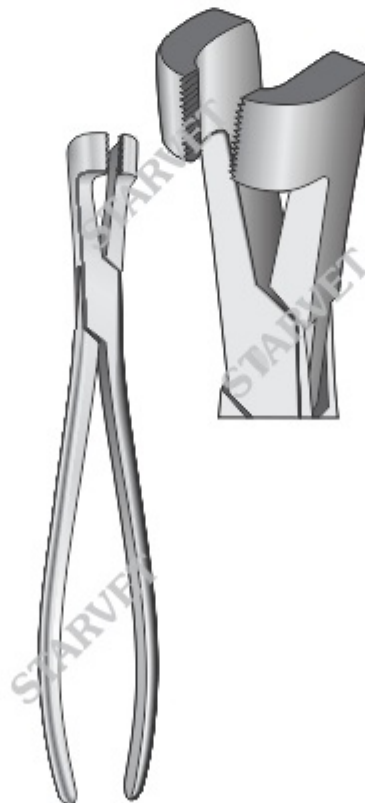

ST05-1220 35.5 cm / 14"  
ST05-1221 40.5 cm / 16"

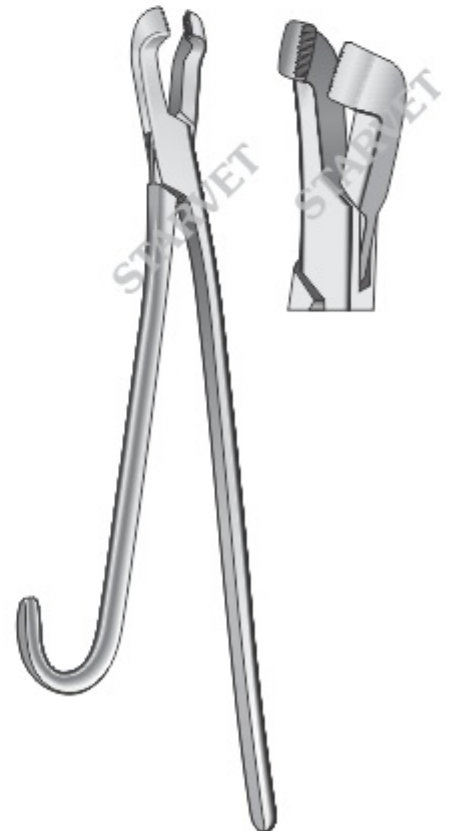

ST05-1230  
43.5 cm / 17 1/4"



ST05-1240  
Universal small tooth  
extraction forcep



ST05-1250 Upper Jaw  
ST05-1251 Lower Jaw  
43.5 cm / 17½"  
Apple Jaw

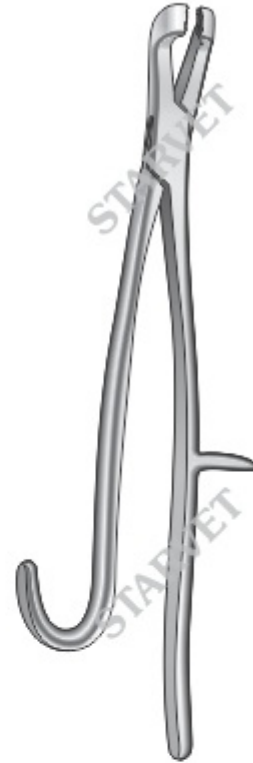

ST05-1260 Upper Jaw  
ST05-1261 Lower Jaw  
43.5 cm / 17½"  
Serrated Jaw



Gunther  
ST05-1270 43 cm / 16"  
ST05-1271 50 cm / 19¼"

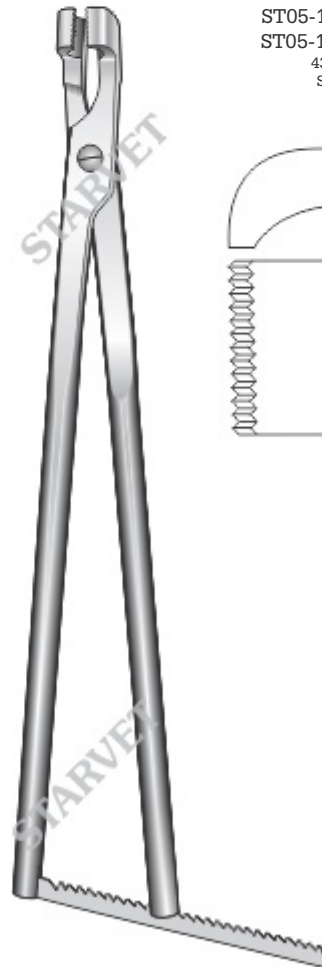

Cheek Spreader  
ST05-1280  
56.5 cm / 22¼"

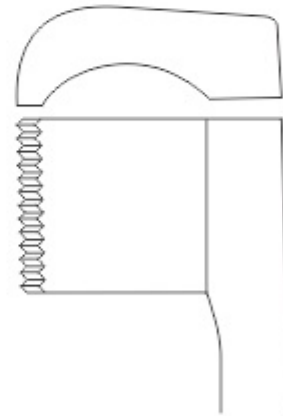



ST05-1290 Upper Molars  
St05-1291 Lower Molars  
54 cm / 21¼"



ST05-1300



Universal Forceps  
ST05-1310  
52 cm / 20¼"



ST05-1320 36 cm / 14"  
ST05-1321 40 cm / 16"



ST05-1330  
41.5 cm / 16 1/4"



ST05-1340  
45 cm / 17 1/4"

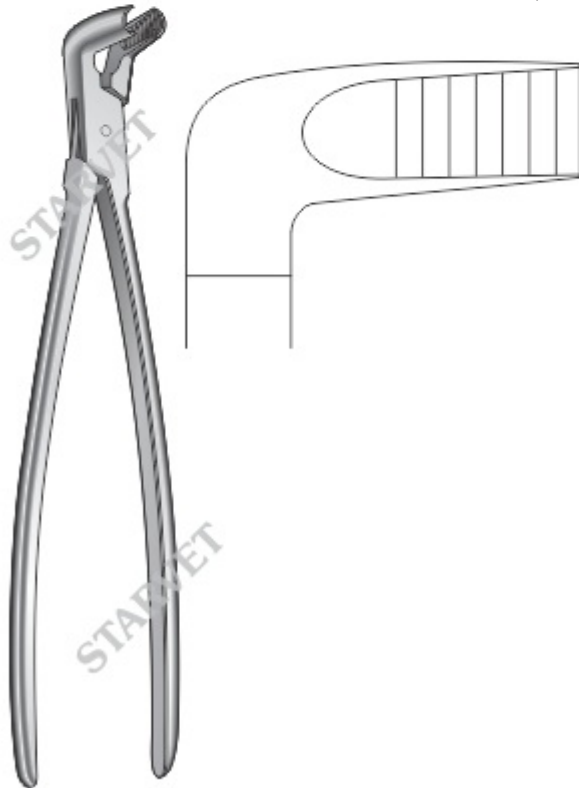

ST05-1350 12 cm / 4 3/4"  
ST05-1351 20 cm / 8"



ST05-1360 36 cm / 14"  
ST05-1361 40 cm / 16"  
ST05-1362 49 cm / 19 1/4"



Pony  
ST05-1370  
47.5 cm / 18¾"

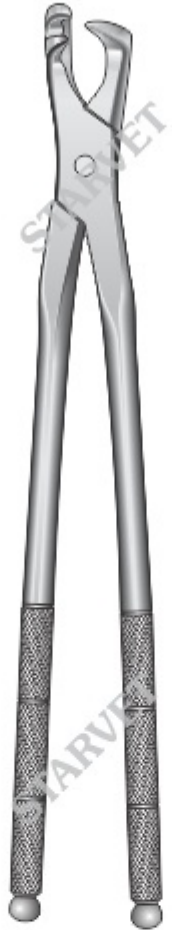

ST05-1380 30.5 cm / 12"  
ST05-1381 40.5 cm / 16"  
ST05-1382 49 cm / 19¼"

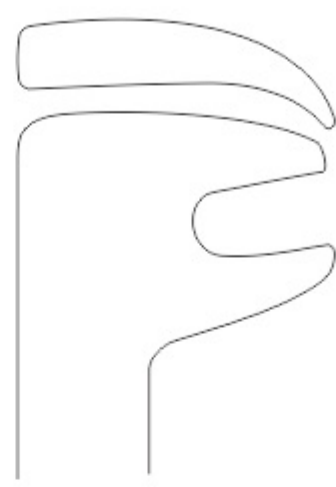

ST05-1390 30.5 cm / 12"  
ST05-1391 40.5 cm / 16"  
ST05-1392 49 cm / 19¼"

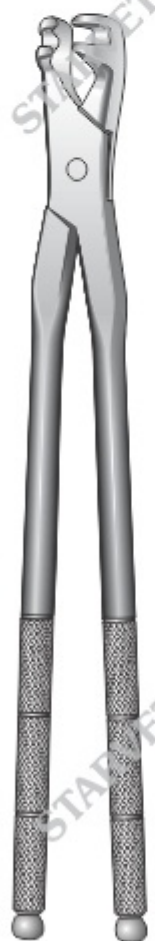

ST05-1400 30.5 cm / 12"  
ST05-1401 40.5 cm / 16"  
ST05-1402 49 cm / 19¼"



ST05-1410  
30 cm / 12"



ST05-1420  
30 cm / 12"



# STARVET

Veterinary Instruments

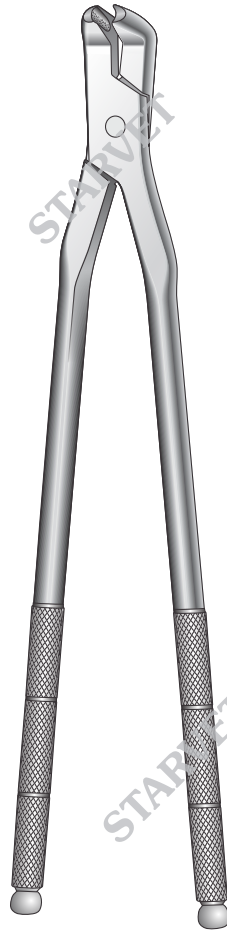



ST05-1480  
49 cm / 19 1/4"



ST05-1590  
48.5 cm / 19"



ST05-1500  
48.5 cm / 19"



ST05-1510 30.5 cm / 12"  
ST05-1511 40.5 cm / 16"  
ST05-1512 49 cm / 19 1/4"



ST05-1520 40.5 cm / 16"  
ST05-1521 49 cm / 19 1/4"



ST05-1530 30.5 cm / 12"  
ST05-1531 40.5 cm / 16"  
ST05-1532 49 cm / 19 1/4"





ST05-1540  
36 cm / 14½"



Slim Model  
ST05-1560 40.5 cm / 16"  
ST05-1561 48 cm / 19"



ST05-1550 30.5 cm / 12"  
ST05-1551 48 cm / 19"



ST05-1570 30.5 cm / 12"  
ST05-1571 46 cm / 18¼"



ST05-1580  
49.5 cm / 19½"



ST05-1590  
48 cm / 19"



ST05-1600  
48 cm / 19"



ST05-1610  
48 cm / 19"



ST05-1620 30.5 cm / 12"  
ST05-1621 49 cm / 19¼"



Molar Forceps  
ST05-1630  
56.5 cm / 22¼"  
Fig. A/B

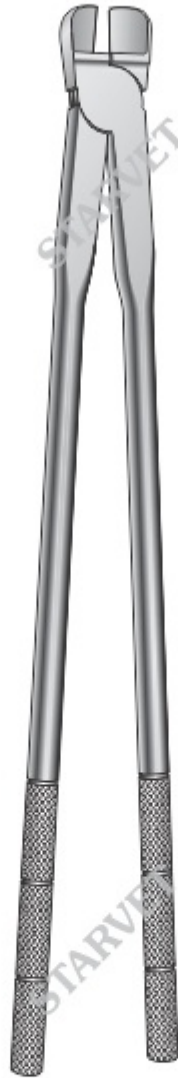

Molar Forceps  
ST05-1640  
56.5 cm / 22¼"  
Fig. A



Molar Forceps  
ST05-1650  
57 cm / 22½"  
Fig. B



Molar Forceps  
ST05-1660  
56.5 cm / 22¼"  
Fig. C



Molar Forceps  
ST05-1670  
49.5 cm / 19½"  
Fig. D



ST05-1680



ST05-1690



ST05-1681

ST05-1682



ST05-1691

ST05-1692



**Compound Molar Cutter**  
63 cm / 24 1/4"  
with detachable handles for easy storage  
tooth cutter for horse

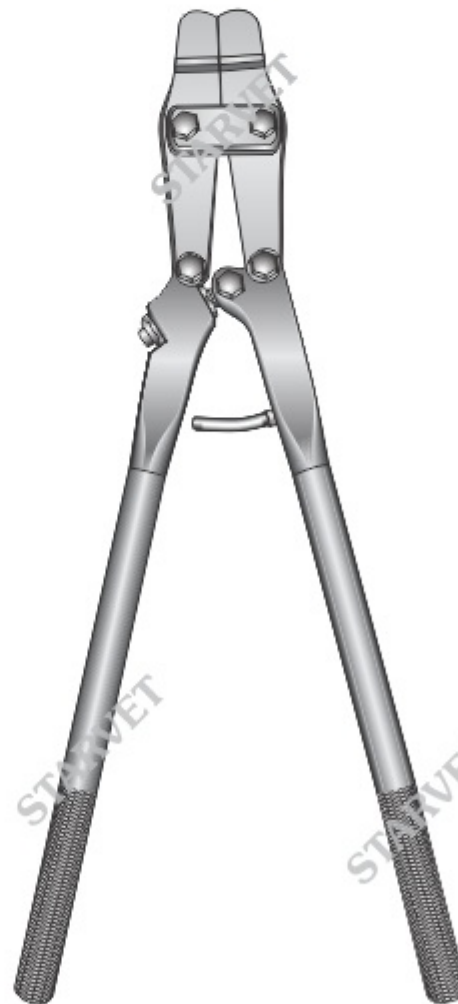

**Compound Action Cutter**  
63 cm / 24 1/4"  
With Detachable handles

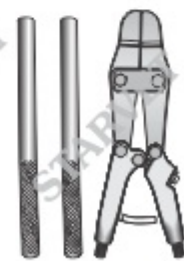

ST05-1700

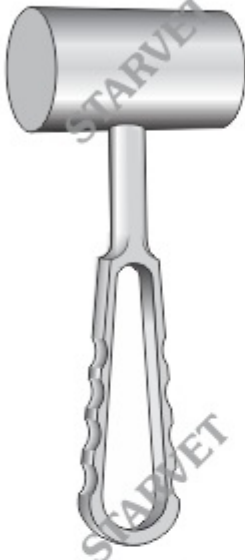

ST05-1710  
18 cm / 7"



Orthopaedic Mallet  
ST05-1720  
140 g



Mallet  
ST05-1730 300 gauge  
ST05-1731 500 gauge, Heavy  
24 cm / 9 1/2"



ST05-1740



ST05-1750



ST05-1760



ST05-1770



ST05-1780  
21 cm / 8¼"



ST05-1790  
21.5 cm / 8½"



ST05-1800  
21 cm / 8¼"



ST05-1810  
21 cm / 8¼"



ST05-1820  
20 cm / 8"



ST05-1830  
21 cm / 8¼"



ST05-1840  
21 cm / 8¼"



ST05-1850  
23 cm / 9"



ST05-1860  
23 cm / 9"



ST05-1870  
21 cm / 8¼"



ST05-1880  
21 cm / 8¼"



ST05-1890  
21 cm / 8¼"

Picture Not Available

New Hoof Knives  
ST05-1900  
No. 7

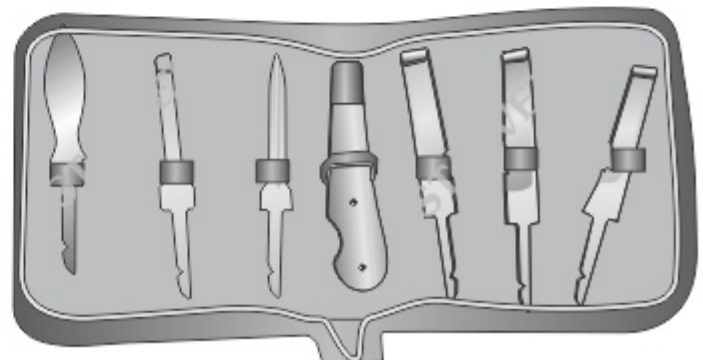

Economy Hoof Knife Set  
ST05-1910  
Economy Hoof Knife Set In Convenient Case.



Avery / Buss  
ST05-1920  
25 cm / 9¾"



ST05-1930  
Wooden Handle



Wamberg  
ST05-1940



ST05-1950



ST05-1960  
18 cm / 7"  
Solid Forged

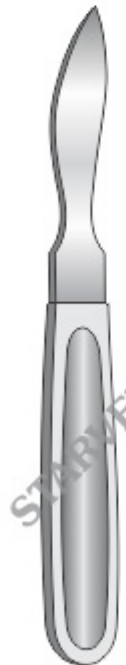

French  
ST05-1970  
18 cm / 7"  
Solid Forged



ST05-1980  
18 cm / 7"  
Solid Forged



French Patta  
ST05-1990  
18 cm / 7"  
Solid Forged



Quittor  
ST05-2000  
18 cm / 7"  
Solid Forged



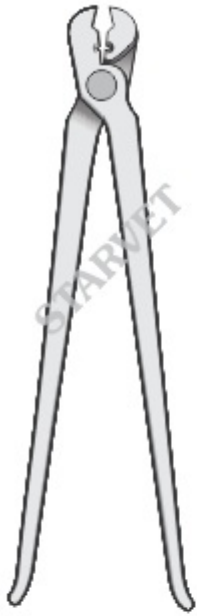

ST05-2010  
32 cm / 12½"



ST05-2020  
29.5 cm / 11½"



ST05-2030  
31 cm / 12¼"



ST05-2040  
31 cm / 12¼"

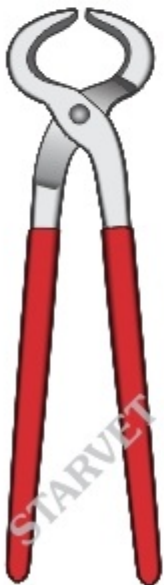

ST05-2050  
30.5 cm / 12"



Hoof Tester  
ST05-2060  
35 cm / 13¾"



ST05-2070  
32 cm / 12½"

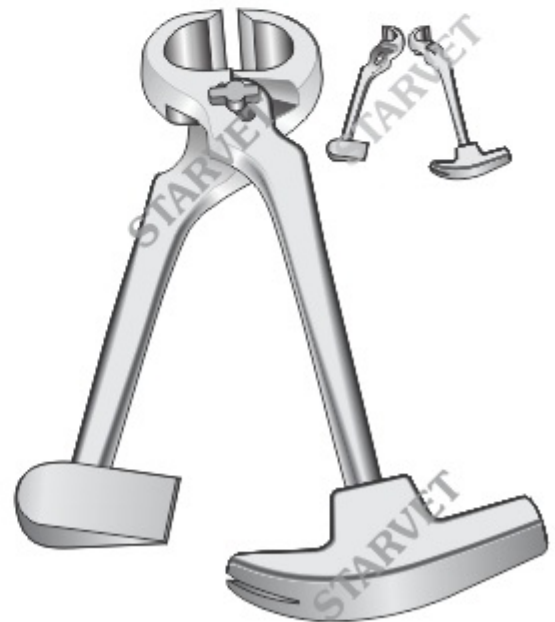

ST05-2080



Clinch Cutter  
ST05-2090  
15 cm / 6"

Double ended for opening the clinches to reduce hoof wall damage during shoe removal. Stainless steel.



ST05-2100  
Pick and Hammer  
Folding



Hoof Buffer  
ST05-2110



Dick (Buffers)  
ST05-2120  
16 cm / 6 1/4"



Dick (Buffers)  
ST05-2130  
16 cm / 6 1/4"



Dick, Scraper  
ST05-2140

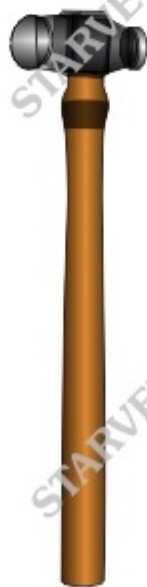

ST05-2150



ST05-2160



ST05-2170



ST05-2180  
Set



ST05-2190  
30 cm / 11 3/4"



ST05-2200  
30 cm / 12"



ST05-2210  
31 cm / 12 1/4"



ST05-2220



ST05-2230



Hoof Knife  
ST05-2240  
Folding



Hoof Rasp  
ST05-2250 Coarse  
ST05-2251 Fine  
Hoof rasp available with either  
fine or coarse teeth.  
Curved profile to aid performance.



ST05-2260



ST05-2270

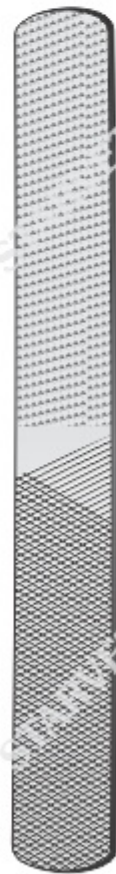

Hoof Rasp  
ST05-2280  
Hoof Rasp - Double Ended, Straight  
Hoof Rasp Available With Both  
Fine And Coarse Teeth.



ST05-2290  
46 cm / 18"



ST05-2300  
43 cm / 17"



Hoof Tester  
ST05-2310  
49.5 cm / 19½"  
Extra Large



ST05-2320  
41 cm / 16"

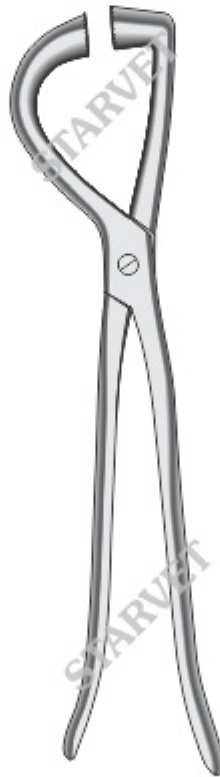

ST05-2330

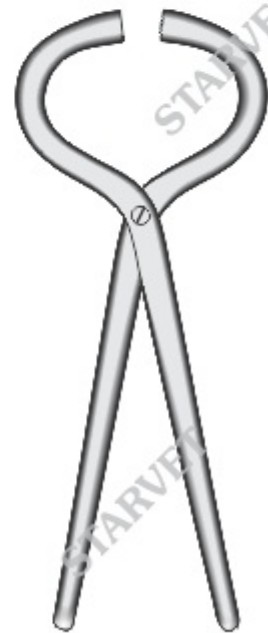

Hoof Tester  
ST05-2340  
33 cm / 13"  
Light Model



Hoof Tester  
ST05-2350

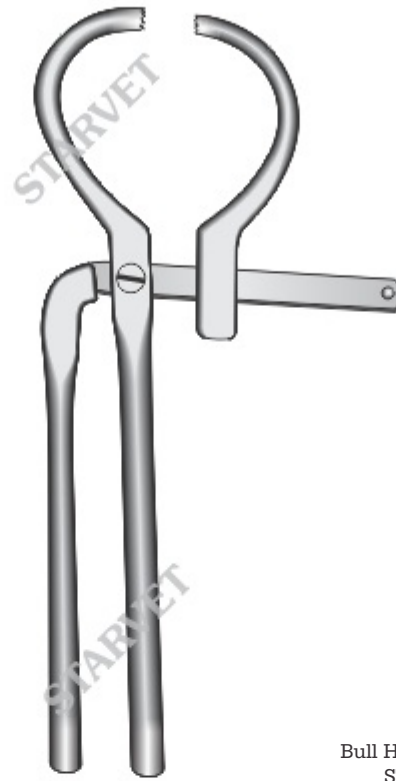

Hoof Tester  
ST05-2360

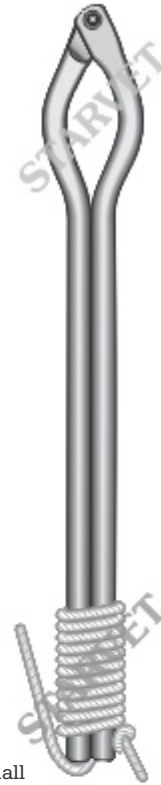

Bull Holder Kendall  
ST05-2370  
40 cm / 15 3/4"



ST05-2380

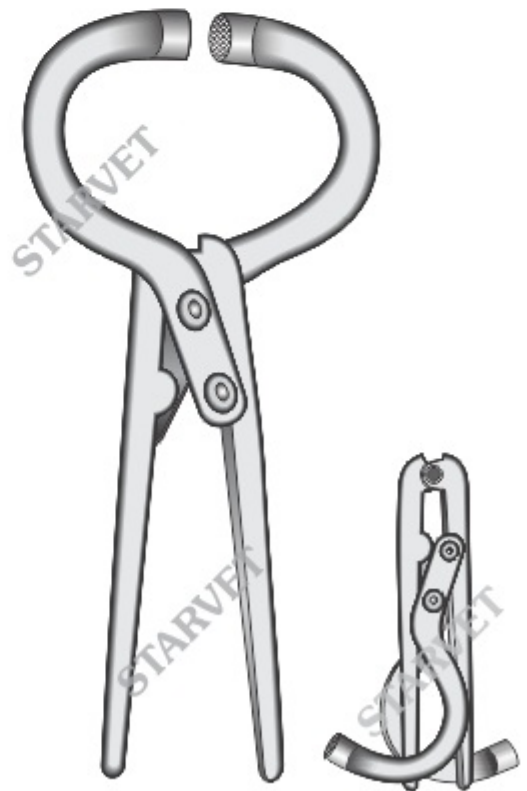

Folding Hoof Tester  
ST05-2390

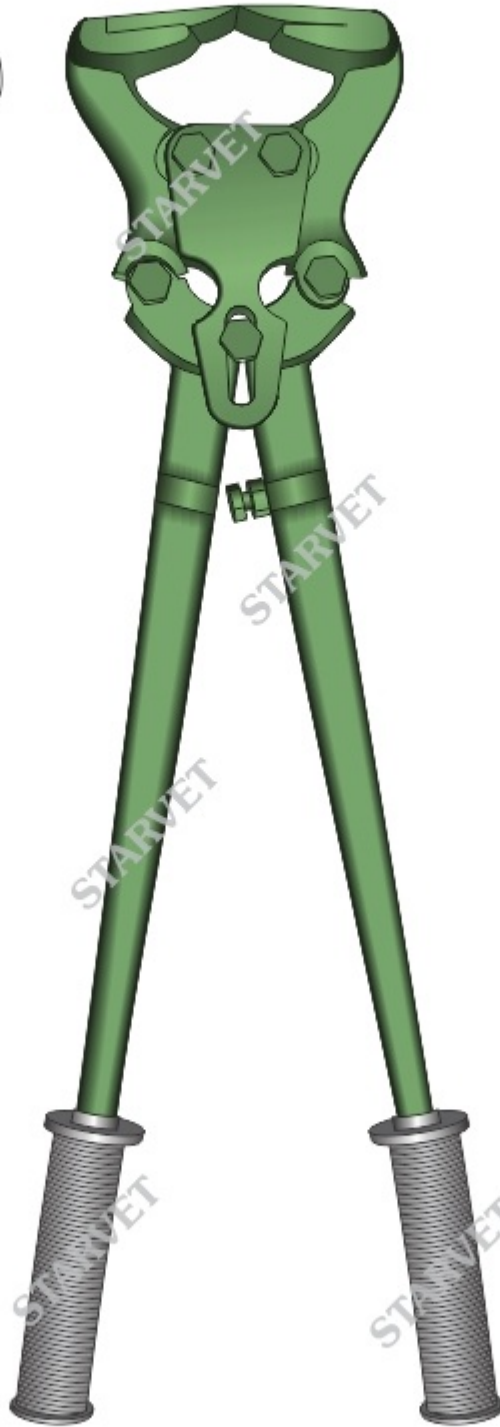
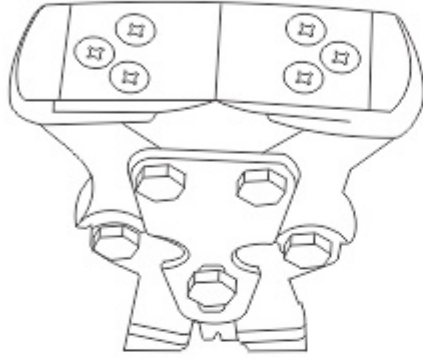

Hoof Instrument Dick  
ST05-2400  
50 cm / 19 3/4"



Pocket Knife  
ST05-2410



Pocket Knife  
ST05-2420

Finger Knife



Linde Knife  
ST05-2430  
10 cm / 4"

Finger Knife



ST05-2440  
6.5 cm / 2½"  
Embryotomy Knife



Spay Scissors  
ST05-2450 30 cm / 11¾"  
ST05-2451 40 cm / 15¼"



Thompson  
ST05-2460



Syme  
ST05-2470  
16 cm / 6¼"  
Solid Forged



Cooper  
Curved Blade  
ST05-2480  
16.5 cm / 6½"  
Solid Forged



ST05-2490  
Straight Blade  
Solid Forged



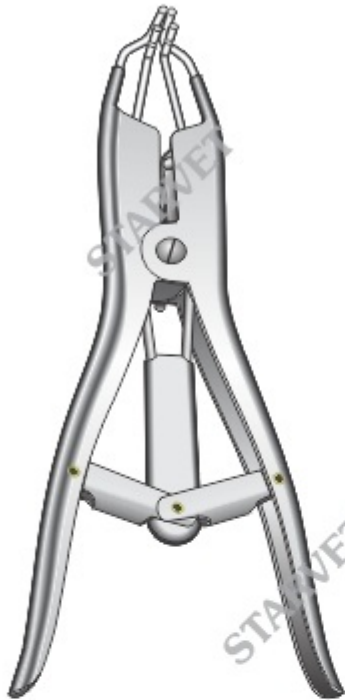

Elastrator Putor  
ST05-2500  
Stainless Steel



ST05-2510



Newbury  
ST05-2520



Castration Forceps  
ST05-2530



Castration Forceps  
ST05-2540



Castration Forceps  
ST05-2550



Castration Forceps  
ST05-2560



Haussmann  
ST05-2570  
19 cm / 7½"  
19 cm / 7½"  
ST05-2571  
23 cm / 9"  
Straight Handle



Haussmann  
ST05-2580 19 cm / 7½"  
ST05-2581 23 cm / 9"  
ST05-2582 27 cm / 10¾"  
ST05-2583 31 cm / 12¼"  
ST05-2584 36 cm / 14¼"  
ST05-2585 48 cm / 19"



Castration Forceps  
ST05-2590



ST05-2600  
19 cm / 7½"  
With Tube



Verboczy  
ST05-2610  
27 cm / 10¾"  
With Double Crush



Haussmann / White  
ST05-2620 19 cm / 7½"  
ST05-2621 31 cm / 12¼"



Bertschy  
ST05-2630  
38 cm / 15"



Sand  
ST05-2640 Straight  
ST05-2641 Curved  
31 cm / 12¼"  
Sand Emasculator



Reimer  
ST05-2650  
31 cm / 12¼"

Bloodless Castrators  
ST05-2660  
23 cm / 9"  
With Card Stop



ST05-2670 30 cm / 11¼"  
ST05-2671 35 cm / 13¾"  
For Lambs, Rams, Pigs, Dogs, Colts  
ST05-2672 40 cm / 15½"  
ST05-2673 48 cm / 19"  
For Bulls, Camels, and Buffalos

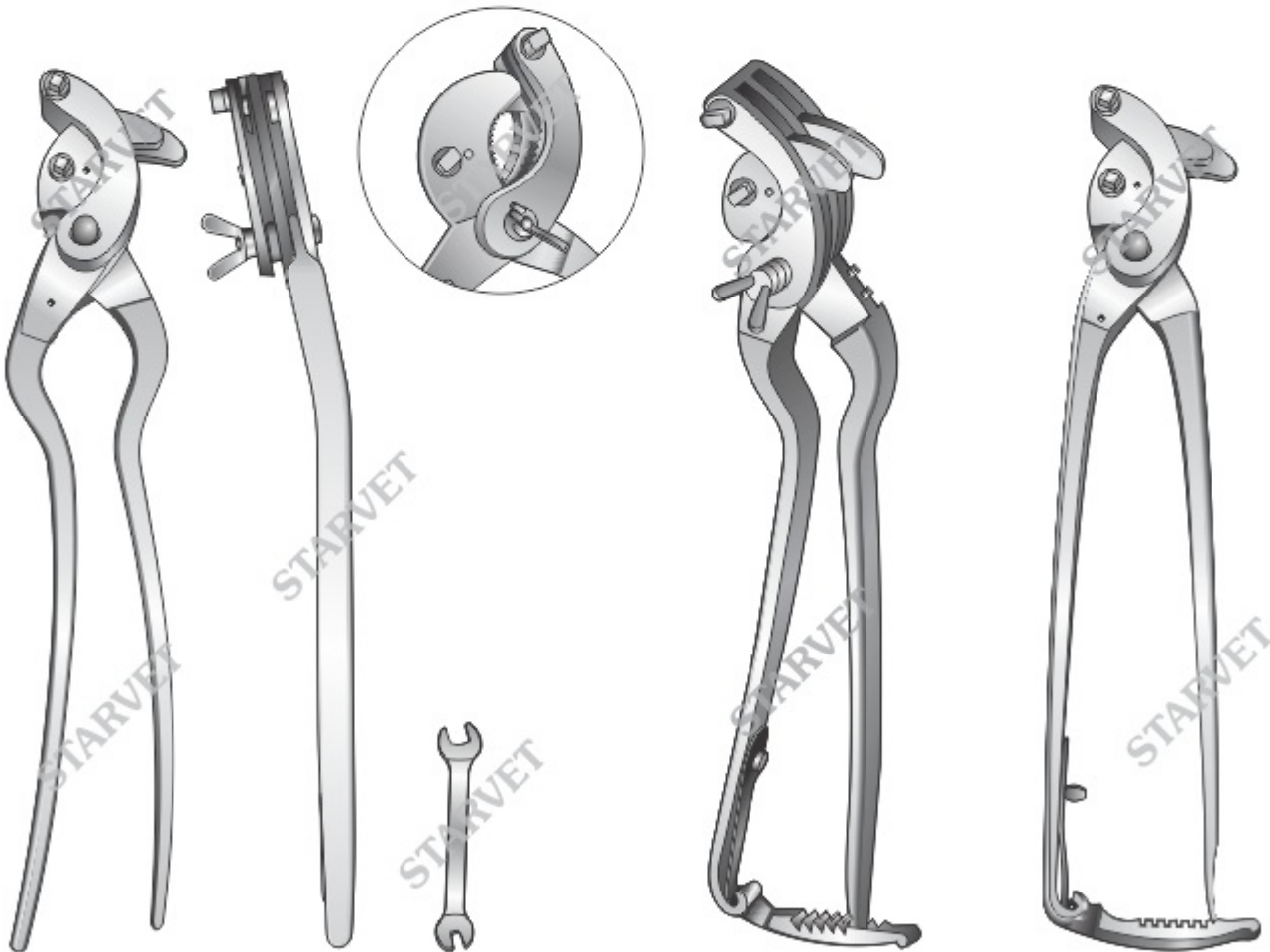

Serra-Modified  
ST05-2680  
35 cm / 13¾"  
Non Slip grip & positive crush  
For one hand use

ST05-2690  
Key

Serra  
ST05-2700  
35 cm / 13¾"  
Modified, with ratchet

Serra  
ST05-2710  
35 cm / 13¾"  
Straight, with ratchet

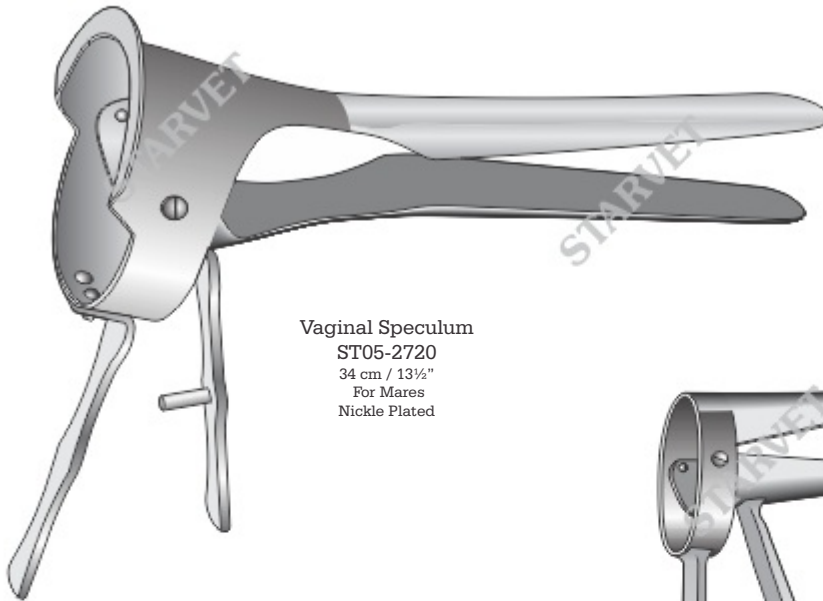

Vaginal Speculum  
ST05-2720  
34 cm / 13½"  
For Mares  
Nickle Plated



Vaginal Specula Russian  
ST05-2730  
10 cm / 4" Blades

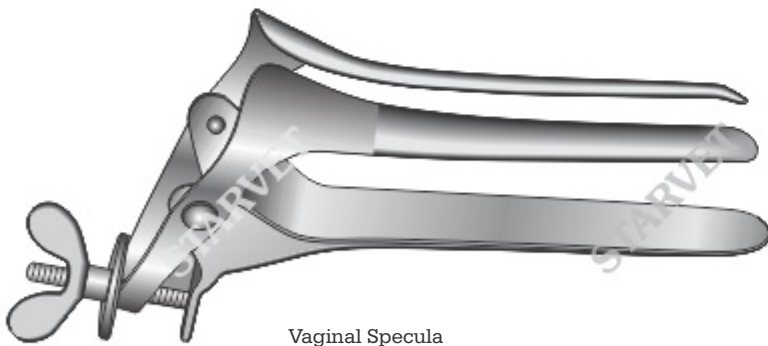

Vaginal Specula  
ST05-2740 27 cm / 10½"  
ST05-2741 40.5 cm / 16"  
Cows Polansky



ST05-2750

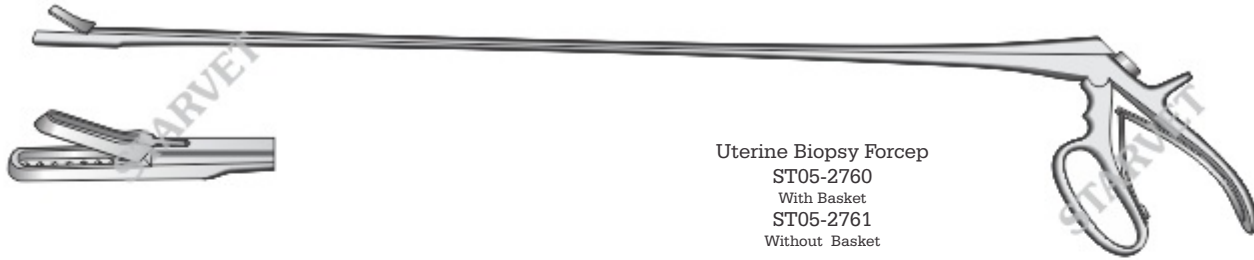

Uterine Biopsy Forcep  
ST05-2760  
With Basket  
ST05-2761  
Without Basket



Chevallier-Jackson  
Endoscopic Biopsy Forceps

ST05-2770 17 cm / 6 3/4"  
ST05-2771 28 cm / 11"  
ST05-2772 35 cm / 13 3/4"  
ST05-2773 50 cm / 19 3/4"

ST05-2780 17 cm / 6 3/4"  
ST05-2781 28 cm / 11"  
ST05-2782 35 cm / 13 3/4"  
ST05-2783 50 cm / 19 3/4"



ST05-2790 17 cm / 6 3/4"  
ST05-2791 28 cm / 11"  
ST05-2792 35 cm / 13 3/4"  
ST05-2793 50 cm / 19 3/4"



ST05-2800 17 cm / 6 3/4"  
ST05-2801 28 cm / 11"  
ST05-2802 35 cm / 13 3/4"  
ST05-2803 50 cm / 19 3/4"

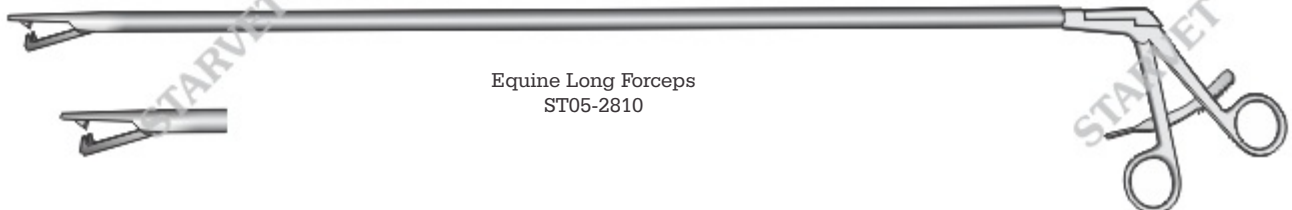

Equine Long Forceps  
ST05-2810



**Balling Gun**

- ST05-2820 31.5 cm / 12½"
- ST05-2821 35 cm / 13¾"
- ST05-2822 43 cm / 17", 15 mm Ø, Small
- ST05-2823 43 cm / 17", 25 mm Ø, Medium
- ST05-2824 56 cm / 22", 35 mm Ø, Large



**Balling Gun**  
ST05-2830  
51 cm / 20"  
Nickle-Plated Metal  
Diameter 30 mm



**Needle For Abdominal Punctate**  
ST05-2840  
15 cm / 6", 4 mm  
For Sampling Of Peritoneal Cavity Fluid In  
Connection With Diagnosis  
& Prognosis Of Surgical Colic



ST05-2850



**Tracheotomy Tube**  
ST05-2860

Inner Ø. 22 mm, Outer Ø. 28 mm



ST05-2870



**Frick's Oral Speculum**  
ST05-2880  
Made of heavy duty stainless steel



**Stomach Pump**

- ST05-2890 40 cm / 16", Small
  - ST05-2891 55 cm / 21½", Medium
- Delivers liquid on both the up & down stroke.



**Cervix**  
ST05-2900  
44 cm / 17", 4 mm Ø  
For Cattle



**ST05-2910**  
44 cm / 17"  
8 mm Ø



**ST05-2920**  
44 cm / 17", 5 mm Ø  
For Cow



**Nielsen**  
ST05-2930  
44 cm / 17"  
5 mm Ø  
For cow



**Imminger / Dawson**  
ST05-2940 23 cm / 9"  
ST05-2941 30 cm / 11¾"  
ST05-2942 38 cm / 15"  
For Cow



**Heatley**  
ST05-2950  
35 cm / 13¾"  
For Cow



**ST05-2960**  
55 cm / 21½"



**ST05-2970**  
44 cm / 17"  
For Cattle





ST05-2980



ST05-2990



ST05-3000



ST05-3010



ST05-3020



ST05-3030



ST05-3040



**Hobday**  
ST05-3050 Blades 25 mm  
ST05-3051 Blades 40 mm  
15 cm / 6"  
Retractor  
Also as Mouth Gag



**Horsley's Trephine**  
ST05-3060 13 mm Ø  
ST05-3061 19 mm Ø  
ST05-3062 25 mm Ø  
ST05-3063 45 mm Ø  
12.5 cm / 5"



**Strawberry Roaring Burr**  
ST05-3070  
21.5 cm / 8½"



**Roaring Burr**  
ST05-3080  
21.5 cm / 8½"  
French model with hooks



**Roaring Burr**  
ST05-3090  
21 cm / 8½"

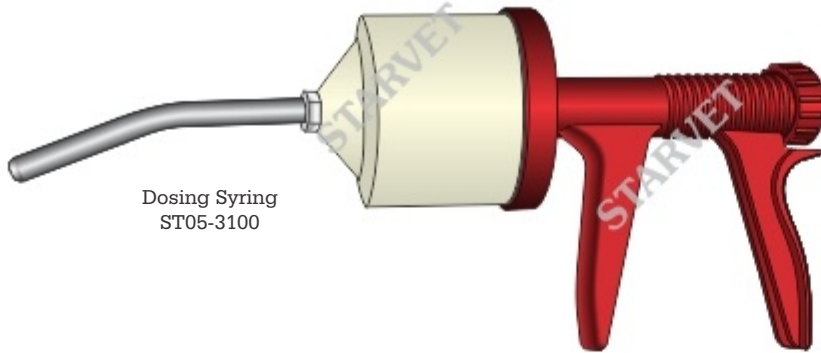

Dosing Syringe  
ST05-3100



ST05-3110

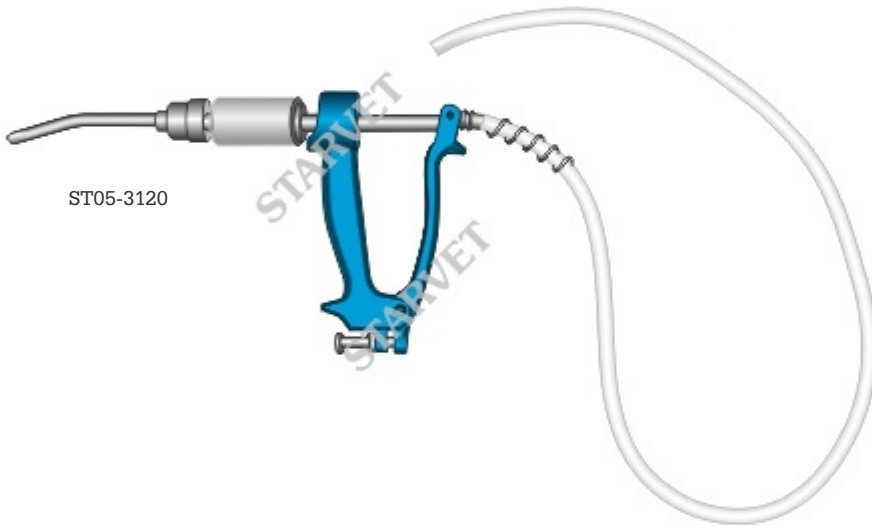

ST05-3120

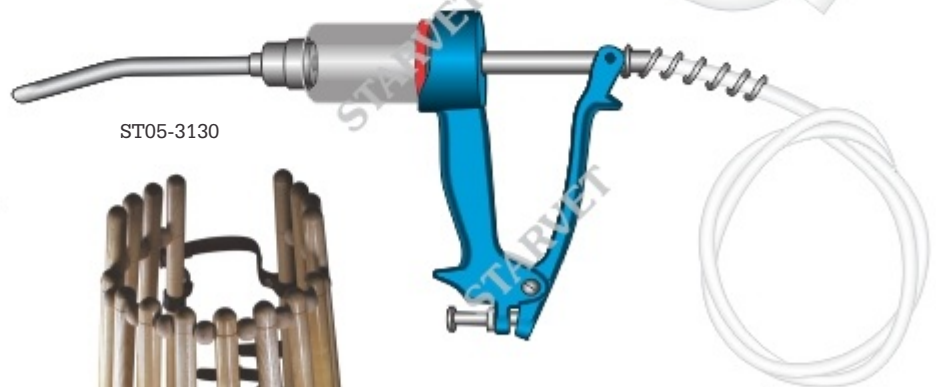

ST05-3130



ST05-3140



ST05-3150



ST06-0001



ST06-0010



ST06-0020  
64 cm / 25"  
Metal



Cats & Dogs Catcher  
ST06-0060  
15.2 cm / 6"



Calf Snare (Cable type).  
ST06-0030  
66 cm / 26"  
Useful in difficult calving for pulling a retracted head for ward or from preventing the head from turning back during delivery.



T-bar Sow OB Snare  
ST06-0050  
25.5 cm / 10"

ST06-0040  
Swine Cable OB Snare

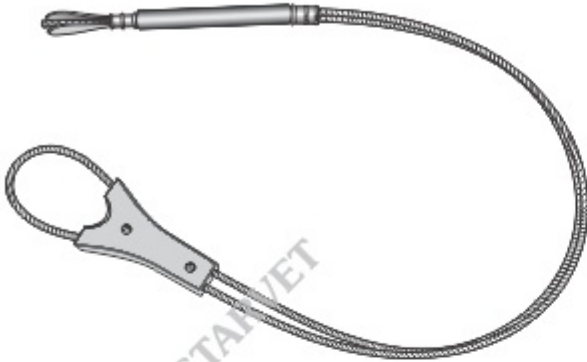

ST06-0070

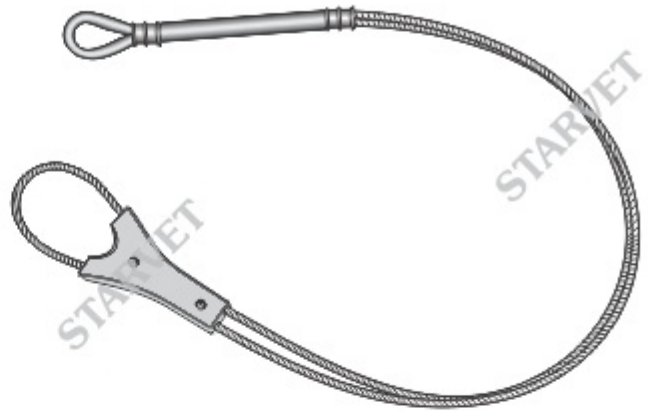

ST06-0080



ST06-0090



ST06-0100



ST06-0110



ST06-0120



ST06-0130



ST06-0140



ST06-0150



ST06-0160



Ecraseur (Chassaignacs)  
ST06-0170  
55 cm / 21½"  
Spove Chain  
Is Also Available  
Stainless steel

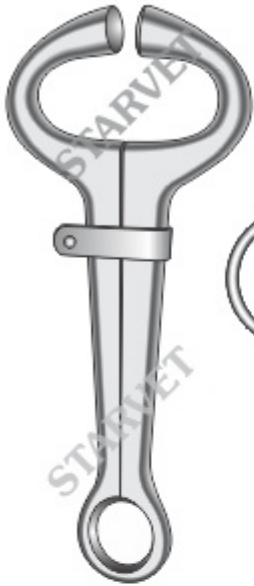

ST06-0180



ST06-0190



ST06-0200

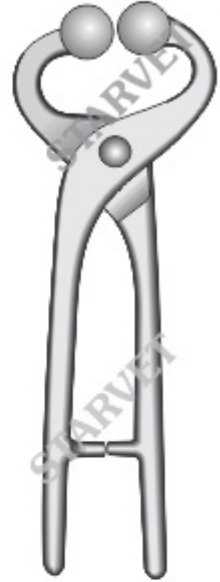

ST06-0210  
22 cm / 8½"  
Chrome Plated Without Chain  
ST06-0211  
Stainless Steel

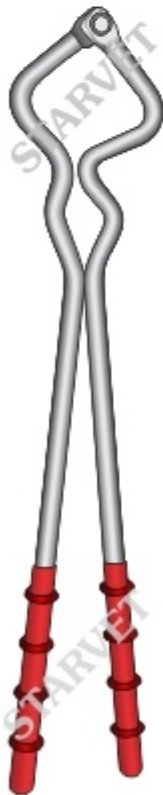

Continental  
ST06-0220  
43 cm / 16¾"



ST06-0230  
53 cm / 20¾"  
Chrome Plated  
ST06-0231  
Stainless Steel

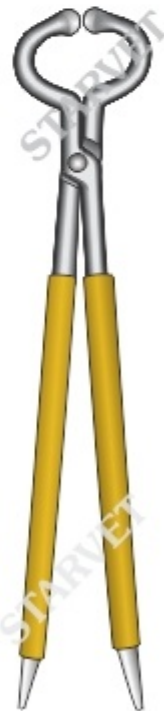

ST06-0240



ST06-0250



ST06-0260

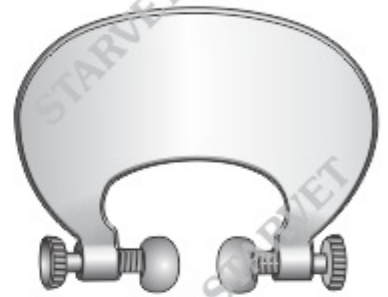

Wilson  
ST06-0270 Size1  
ST06-0271 Size2  
ST06-0272 Size3  
ST06-0273 Size4  
Milk Sucking Preventor  
Aluminum

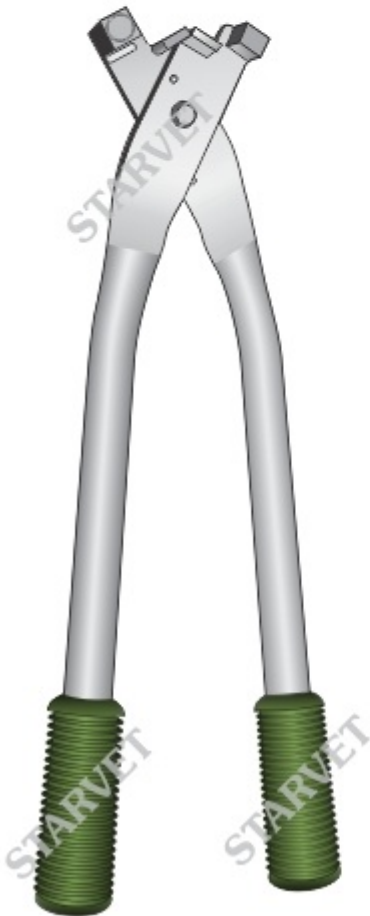

ST06-0310



ST06-0280



ST06-0290



ST06-0300

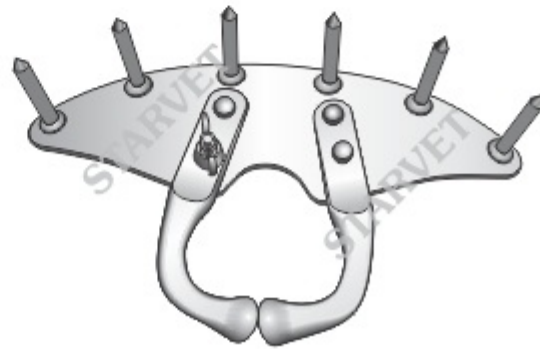

ST06-0320





ST06-0330  
52 mm Ø  
For Pig

Anillo Nasal Rings  
Nose Ring For Pigs (Copper)



ST06-0340  
65 mm Ø  
For Pig

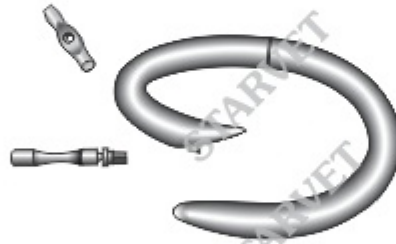

ST06-0350  
58 mm Ø  
For Pig



ST06-0360  
38 cm Ø



ST06-0370 65 cm / 25½"  
ST06-0371 70 cm / 27½"  
ST06-0372 80 cm / 32½"  
For Bulls



ST06-0380  
26 cm / 10¼"



ST06-0390  
26 cm / 10¼"



Frank  
ST06-0400  
26 cm / 10¼"  
Nose Punch



Clip Applying Forceps  
ST06-0410  
17 cm / 6¾"  
Wound clips for skin closures on cattle



ST06-0420



ST06-0430



Schulze  
ST06-0440  
For Horses & Cattle



ST06-0450  
For Pigs



ST06-0460  
For Cattle



Drinkwater  
ST06-0470 Left  
ST06-0471 Right  
Aluminum made

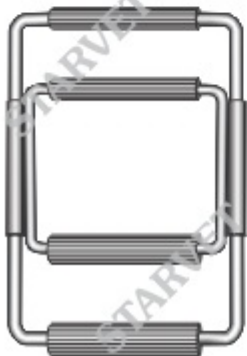

Mouth Gag  
ST06-0480



Weingart  
ST06-0490



ST06-0500



Ostertag  
ST06-0510  
6.5 cm / 2½"



Harm  
ST06-0520 8 cm / 3"  
ST06-0521 10 cm / 4"



Harm  
ST06-0530  
ST06-0531



Freyberger  
ST06-0540  
5.5 cm / 2¼"



ST06-0550



Vogel  
ST06-0560  
11 cm / 4¼"



Vienna  
ST06-0570  
14 cm / 5½"



Ruggeberg  
ST06-0580  
14 cm / 5½"  
Spring Action

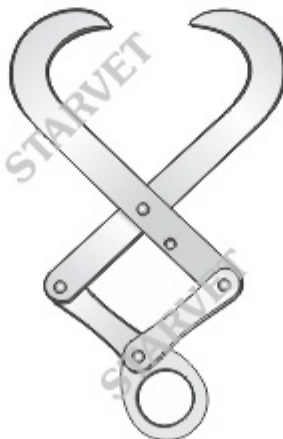

Krey-Schottler  
ST06-0590  
21 cm / 8¼"



Krey-Schottler Heavy  
ST06-0600  
21 cm / 8¼"  
ST06-0601  
1 x 2 teeth



Obermayer  
ST06-0610  
30 cm / 11¼"

Harm  
ST06-0620  
50 cm / 19¾"

William  
ST06-0630  
75 cm / 29½"



ST06-0655

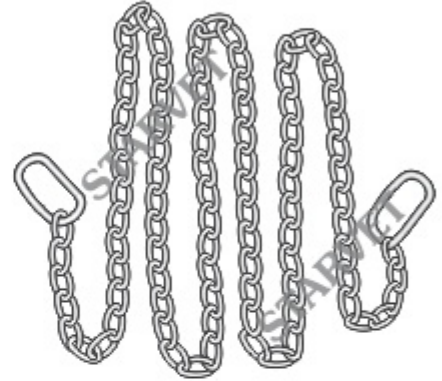

Moore (OB. Chain)  
ST06-0660 26 cm / 10¼"  
ST06-0661 53 cm / 20¾"  
ST06-0662 75 cm / 29½"  
ST06-0663 150 cm / 59"  
ST06-0664 190 cm / 74¾"



ST06-0670  
O.B. Chain Handle  
ST06-0700  
Dipping Model



ST06-0680  
O. B. Chain Handle



ST06-0690  
O,B chain Handle



ST06-0710



ST06-0720



ST06-0730



ST06-0740



ST06-0750



ST06-0760



ST06-0770



ST06-0780



ST06-0790



Keller  
ST06-0800  
75 cm / 29½"



Caemmerer  
ST06-0810  
78 cm / 30¾"  
Torsion Fork



Benesch / Kuhn  
ST06-0820  
84 cm / 33"  
Crutch



ST06-0830  
Detorsion rod



ST06-0840  
Wire And Rope Carrier



Sand  
ST06-0850  
19 cm / 7½"  
Light Model  
Wire & Rope Carrier



Sand  
ST06-0860  
19 cm / 7½"  
Wire & Rope Carrier



ST06-0870  
71 cm / 28"  
Embryotome tube (complete)



Thygesen's Fetatome  
ST06-0880  
84 cm / 33"  
Two-tube model With adjustable handle for OB Chain. This is the breakdown model, complete with insertion coil and cleaning brush.



Utrecht Feta-Tome  
ST06-0890  
96.5 cm / 38"  
Light Weight



ST06-0900  
86 cm / 33 3/4"



Schriever  
ST06-0910  
Rope Introducer





Sutter  
ST06-0920  
Embryotome  
Saw Handle



ST06-0930  
White Handle

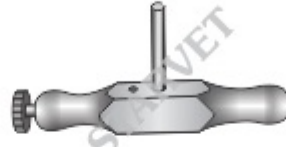

ST06-0940



Lyes  
ST06-0950  
Handle



Swedish Model  
ST06-0960



O.B Chain with Handle  
ST06-0970



Witte  
ST06-0980  
31 cm / 12"



Anti cow kick  
ST06-0990



ST06-0995

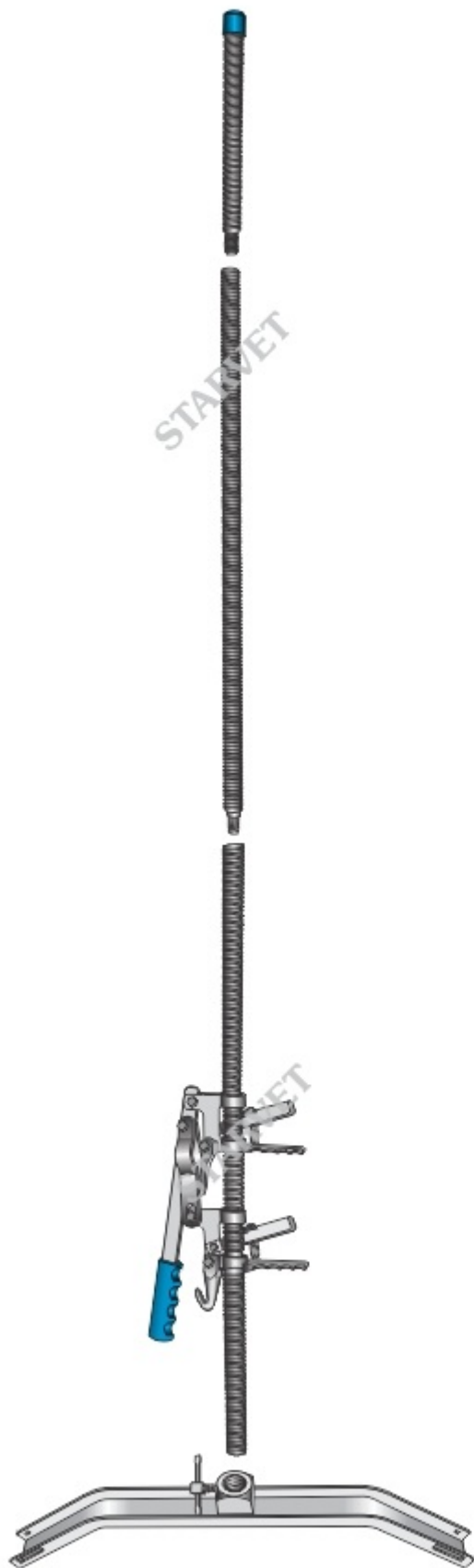

ST06-1000  
Un Assembled

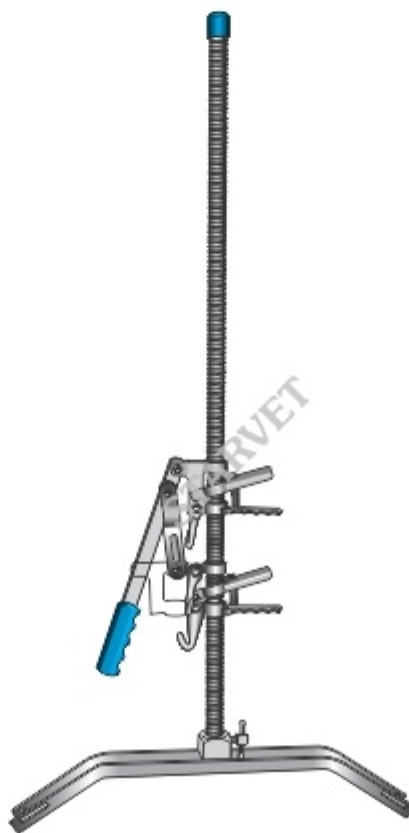

Assembled



Calf Puller  
ST06-1010



**ST06-1020**  
9 cm / 3½"  
2.1 mm



**Sudan Patt.**  
**ST06-1030**  
9 cm / 3½"  
6 mm



**Hannover**  
**ST06-1040** 6 cm 2½", 2.2 mm  
**ST06-1041** 8 cm / 3", 2.3 mm  
**ST06-1042** 10 cm / 4", 3.0 mm



**Troester**  
**ST06-1050**  
8 cm / 3"



**Buhner**  
**ST06-1060** 18 cm / 7"  
**ST06-1061** 23 cm / 9"  
**ST06-1062** 30 cm / 11¾"



**Gerlach / Buhner**  
**ST06-1070** 18 cm / 7"  
**ST06-1071** 23 cm / 9"  
**ST06-1072** 24 cm / 9½"



**ST06-1080**  
11 cm / 4¼"  
Vulva Suture Pin  
Needle only.



**Plastic Balls**  
**ST06-1090**

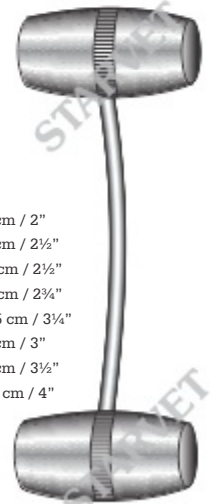

**Plastic Stoppers**  
**ST06-1100**  
German Silver Rod

**ST06-1101** 5 cm / 2"  
**ST06-1102** 6 cm / 2½"  
**ST06-1103** 6 cm / 2½"  
**ST06-1104** 7 cm / 2¾"  
**ST06-1105** 7.5 cm / 3¼"  
**ST06-1106** 8 cm / 3"  
**ST06-1107** 9 cm / 3½"  
**ST06-1108** 10 cm / 4"



ST06-1120



ST06-1130



ST06-1140 4 mm Ø  
ST06-1141 5 mm Ø  
ST06-1142 6 mm Ø  
Shaft 9 cm / 3½"

ST06-1143 8 mm Ø  
ST06-1144 9 mm Ø  
Shaft 15 cm / 6"  
For Sheep



ST06-1150 10 x 4 mm Ø  
ST06-1151 11 x 5 mm Ø  
ST06-1152 12 x 3 mm Ø  
ST06-1153 13 x 7 mm Ø  
ST06-1154 18 x 7 mm Ø  
ST06-1155 28 x 5 mm Ø



ST06-1160 9 cm / 3½", 6 x 3 mm Ø  
ST06-1161 16 cm / 6¼", 9 x 7 mm Ø  
ST06-1162 16 cm / 6¼", 12 x 7 mm Ø  
ST06-1163 16 cm / 6¼", 15 x 10 mm Ø  
Oval shape, For sheep & cattle  
Also available in wooden handle

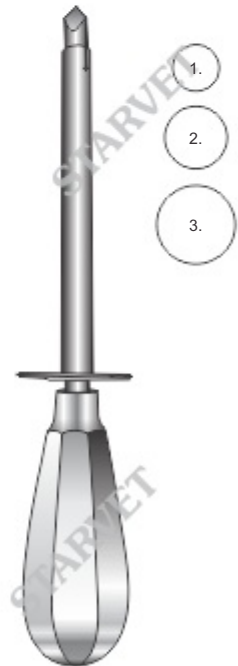

ST06-1170 9 x 5 mm Ø  
ST06-1171 12 x 12 mm Ø  
ST06-1172 15 x 15 mm Ø  
with one spare cannula

Sharp point prob PC

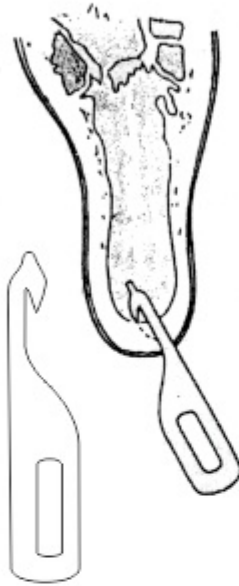

Dyakjaer  
ST06-1180



Lichy  
ST06-1190  
12 cm / 4¾"



Hug  
ST06-1200  
15 cm / 6"  
Lancet



Mclean  
ST06-1210



Stoll  
ST06-1220  
15 cm / 6"



Hall  
ST06-1230  
12 cm / 4¾"



Danish Model  
ST06-1240  
13 cm / 5"



USA-Model  
ST06-1250  
12 cm / 4¾"



Greene  
ST06-1260  
15 cm / 6"



ST06-1270



ST06-1280



Christensen  
ST06-1290  
15 cm / 6"



ST06-1300  
11 cm / 4¼"  
ST06-1301  
14 cm / 5½"



ST06-1310  
10 cm / 4"  
Short Model

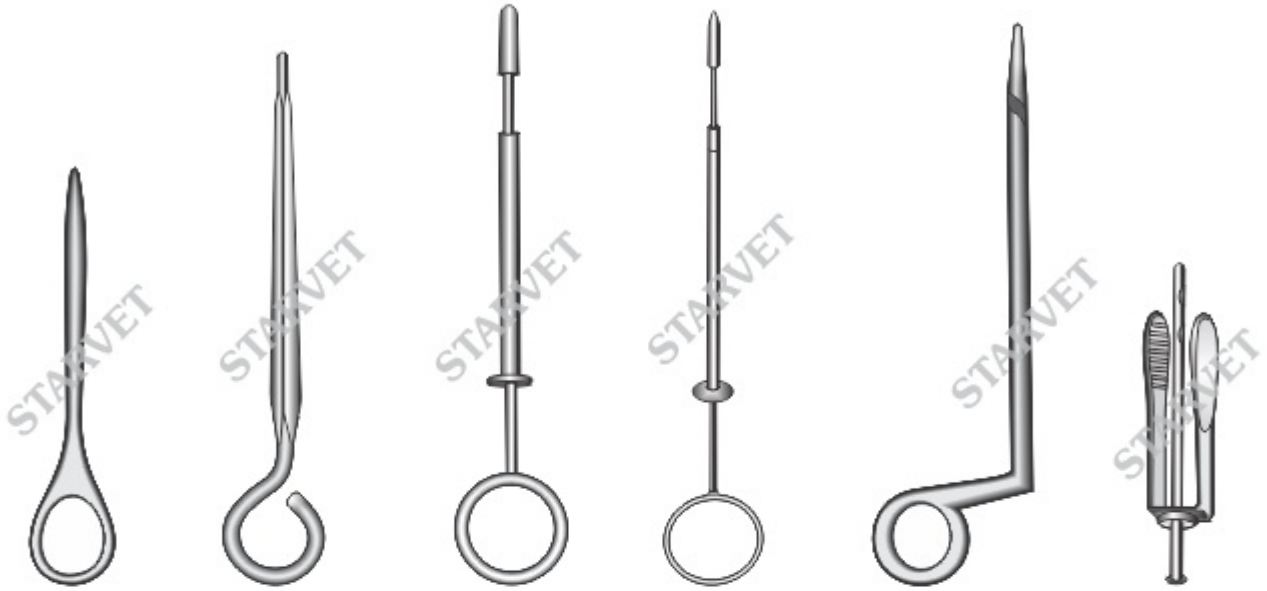

Schecker  
ST06-1320  
11 cm / 4 1/4"

French Model  
ST06-1330 6.5 cm / 2 1/2"  
ST06-1331 10 cm / 4"  
Papillotome

Hug  
ST06-1340  
13 cm / 5"

Swiss Model  
ST06-1350  
10 cm / 4"

Barrett  
ST06-1360  
15 cm / 6"

Self Retaining  
ST06-1370  
9 cm / 3 1/2"

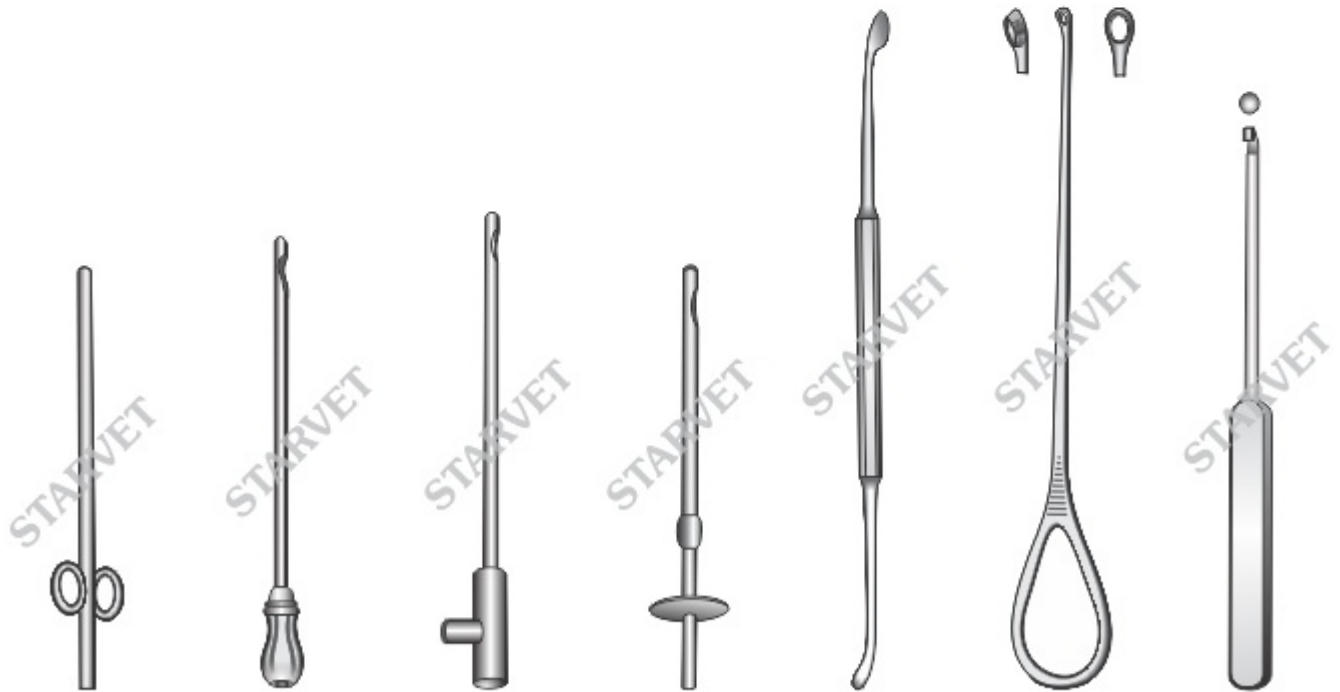

ST06-1380  
9 cm / 3 1/4"  
ST06-1381  
10 cm / 4"

ST06-1390  
10 cm / 4"

ST06-1400  
10 cm / 4"

ST06-1410  
10 cm / 4"

Mose  
ST06-1420  
15 cm / 6"

Ullner  
ST06-1430  
18 cm / 7"

Cornell  
ST06-1440  
15 cm / 6"

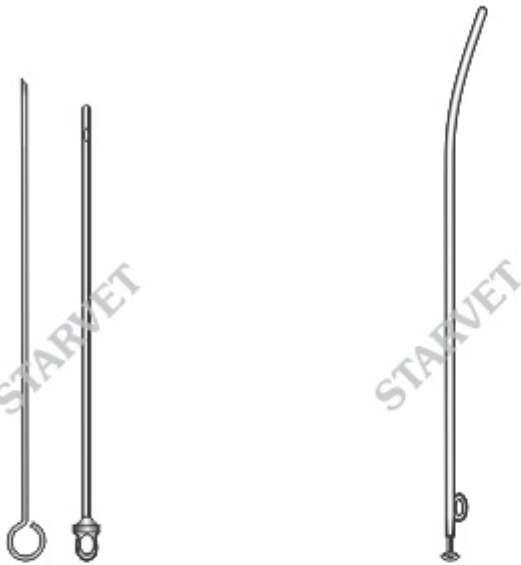

Gray  
ST06-1450  
16 cm / 6¼"  
3 mm Ø  
For cats

ST06-1460  
23 cm / 9"  
2.5 mm Ø  
For Bitch



Dose Adaptor

ST06-1470	10 cm / 4"	ST06-1471
ST06-1472	15 cm / 6"	ST06-1473



ST06-1480  
30 cm / 11¾"  
3 mm Ø  
For dogs



ST06-1490  
23 cm / 9"  
(Improved Pattern)



ST06-1500  
ST06-1501  
ST06-1502  
ST06-1503  
20 cm / 8"  
For Dogs



ST06-1510



ST06-1520





ST06-1530  
ST06-1531  
ST06-1532



**Hornfisher**  
ST06-1540 3 cm / 1"  
ST06-1541 3.8 cm / 1½"  
ST06-1542 4.8 cm / 2"



**Roberts**  
ST06-1550  
13 cm / 5"



ST06-1560  
Rubber



ST06-1570  
26 cm / 10¼"

Stauching



**Schecker**  
ST06-1580  
31 cm / 12¼"



ST06-1590 12 cm / 4¾"  
ST06-1591 15 cm / 6"  
Aluminum Made  
for dog's ear docking  
Straight



ST06-1600 12 cm / 4¾"  
ST06-1601 15 cm / 6"  
Curved



ST06-1610



ST06-1620



ST06-1630



ST06-1640



ST06-1650



Gould  
ST06-1660  
26 cm / 10 1/4"



ST06-1670



ST06-1690



ST06-1700



ST06-1710

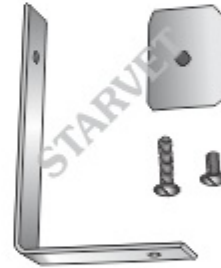

ST06-1720

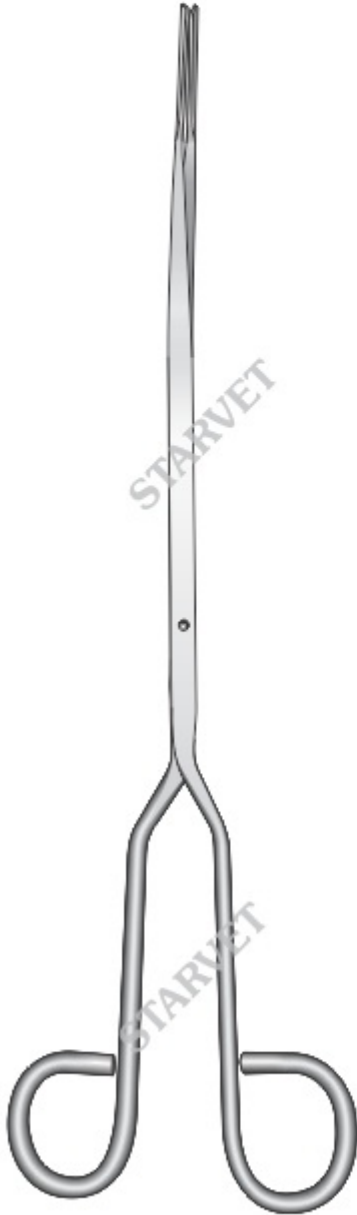

ST06-1680



ST06-1730

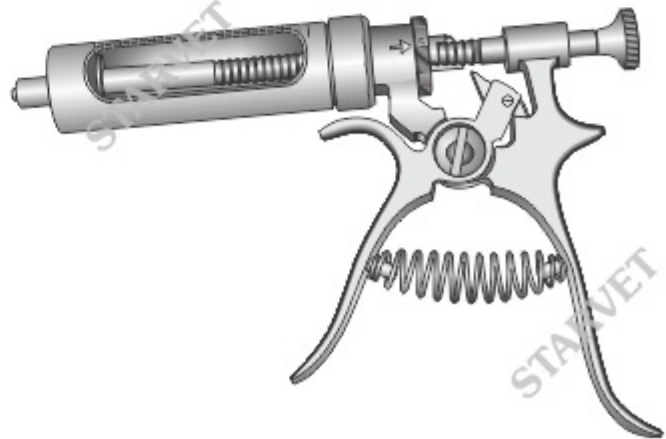

ST06-1740



ST06-1750



ST06-1760



ST06-1770



ST06-1780



ST06-1790



ST06-1801

ST06-1800



ST06-1810



ST06-1820



ST06-1830

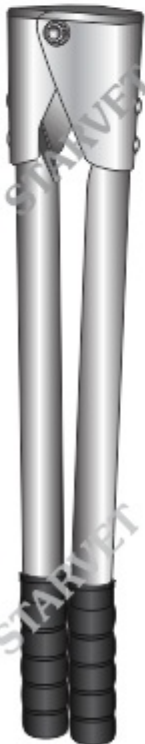

ST06-1840

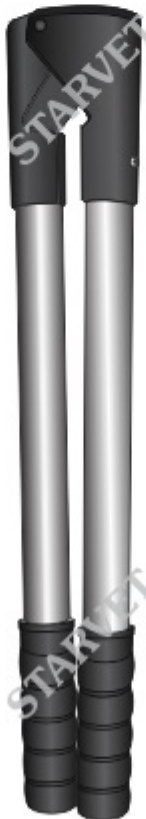

ST06-1850



ST06-1860

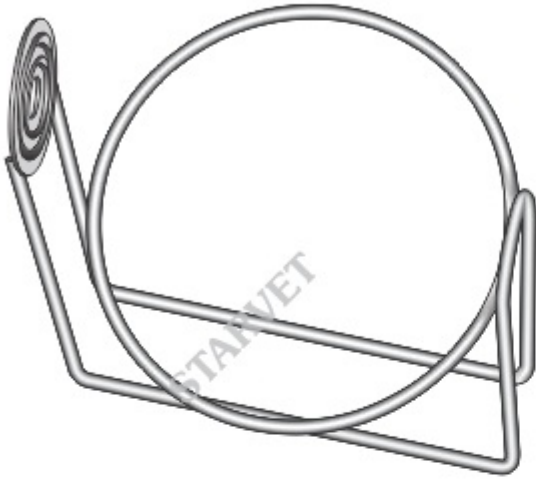

ST06-1870

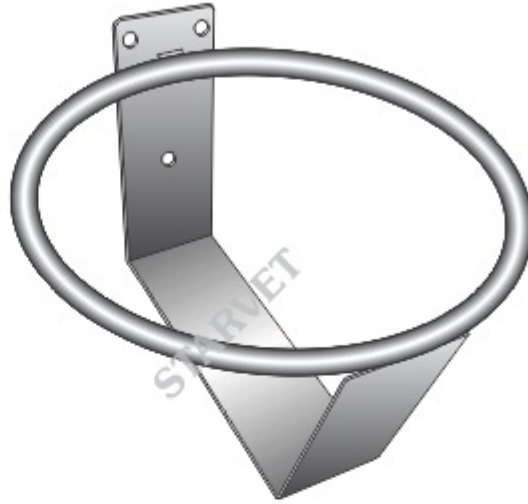

ST06-1880



ST06-1890

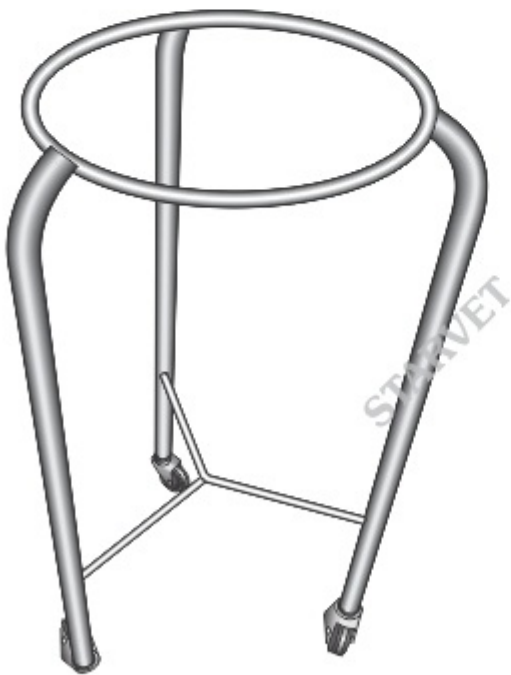

ST06-1900

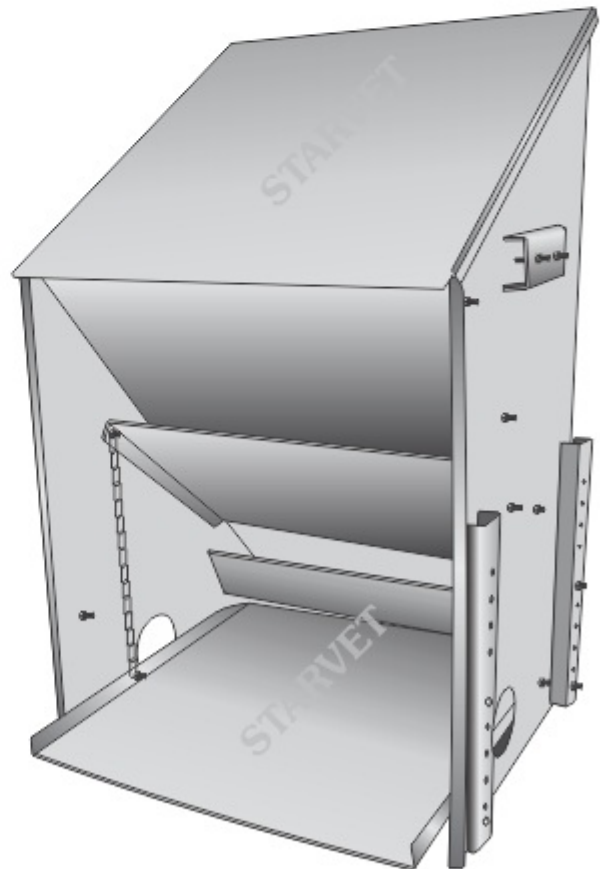

ST06-1910



ST06-1920



ST06-1930

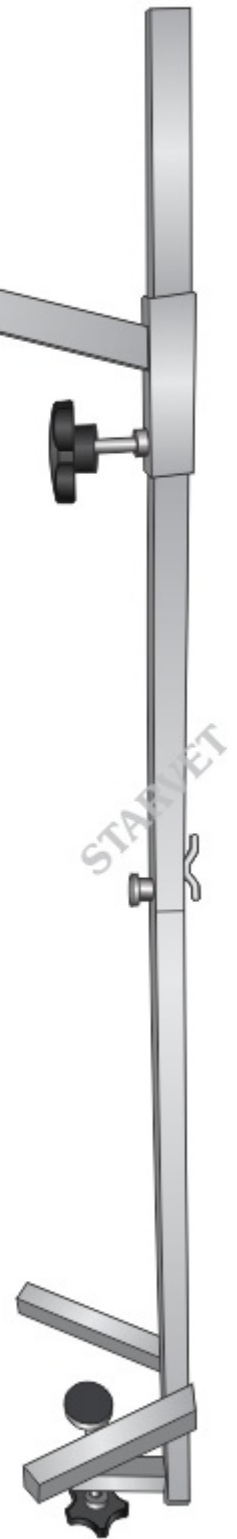

ST06-1940

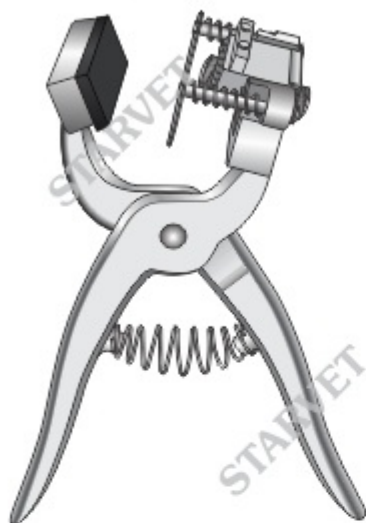

ST06-1950



ST06-1960



ST06-1970



Marking Plier  
ST06-1980 1 mm hole  
ST06-1981 2 mm hole



Marking Plier  
ST06-1990 1 mm hole  
ST06-1991 2 mm hole



ST06-2000



ST06-2010



ST06-2011



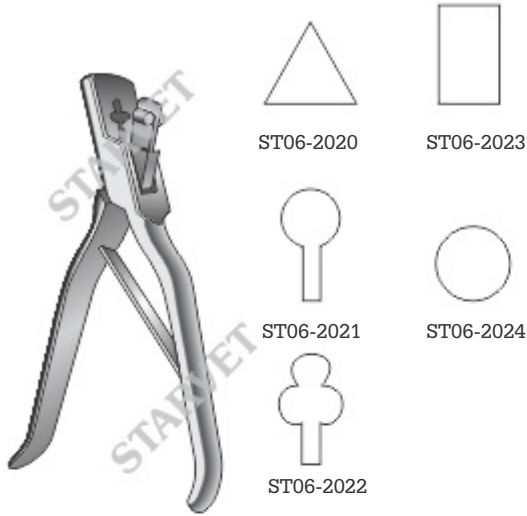

Ear Marking Plier  
20 cm / 8"

For cutting designs at edge of ears

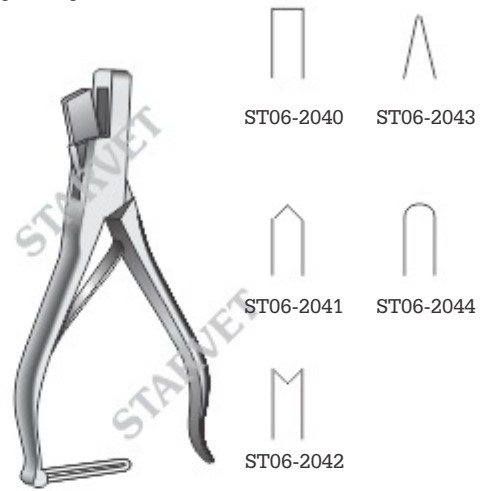

Ear Marking Plier  
15 cm / 6"





ST06-2150  
13 cm / 5"



ST06-2160 14 cm / 5½"  
ST06-2161 16 cm / 6¼"



Turnbull  
ST06-2170 11.5 cm / 4½"  
ST06-2171 13 cm / 5"



ST06-2180  
15.5 cm / 6"



ST06-2190  
14 cm / 5½"



ST06-2200  
11 cm / 4¼"



ST06-2210 11 cm / 4¼"  
ST06-2211 13 cm / 5"  
ST06-2212 15 cm / 6"



ST06-2220  
12 cm / 4¾"



ST06-2230  
13 cm / 5"



ST06-2240



ST06-2250



ST06-2260  
10.5 cm / 4¼"



Hobday  
ST06-2270  
10 cm / 4"  
For Toe Nail



Bird Scissor  
ST06-2280  
13.5 cm / 5¼"



Toe Nail Scissor  
ST06-2290  
Angled



ST06-2300 9 cm / 3½"  
ST06-2301 10 cm / 4"  
ST06-2302 11 cm / 4½"



ST06-2310 9 cm / 3½"  
ST06-2311 10 cm / 4"  
ST06-2312 11 cm / 4½"



ST06-2320  
10.5 cm / 4¼"



ST06-2330  
10.5 cm / 4¼"

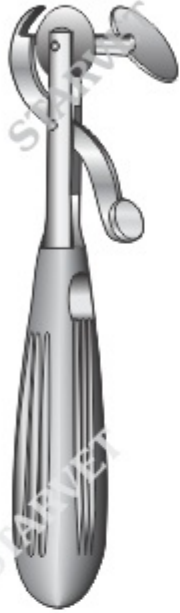

Walton  
ST06-2340  
16 cm / 6¼"  
ST06-2341  
Spare blade for ring cutters



ST06-2350  
17 cm / 6¾"  
Ring cutter

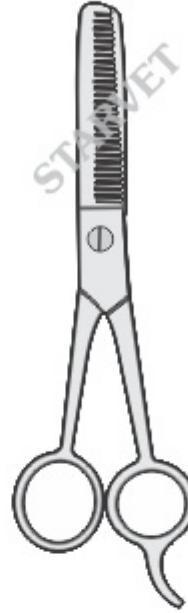

ST06-2360  
11 cm / 4¼"  
Thinning Scissors

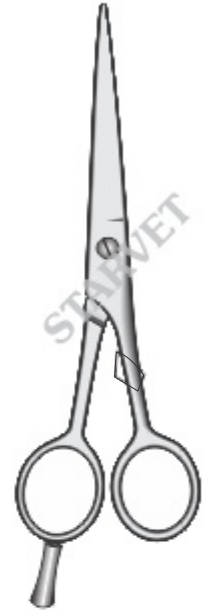

ST06-2370  
11 cm / 4¼"  
Barber Scissors



ST06-2380 10 cm / 4"  
ST06-2381 12 cm / 4¾"



ST06-2390  
11 cm / 4½"



Guillotine  
ST06-2400

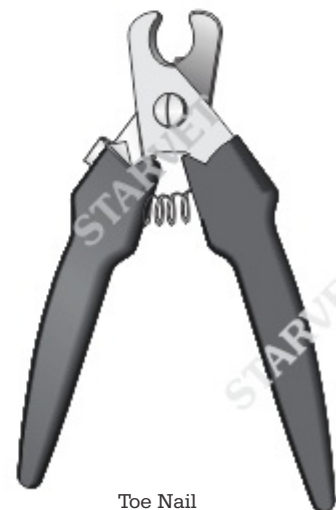

Toe Nail  
ST06-2410  
Heavy Duty

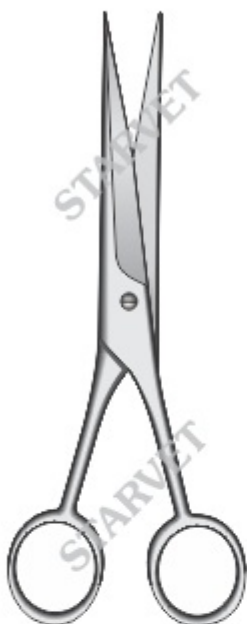

ST06-2420

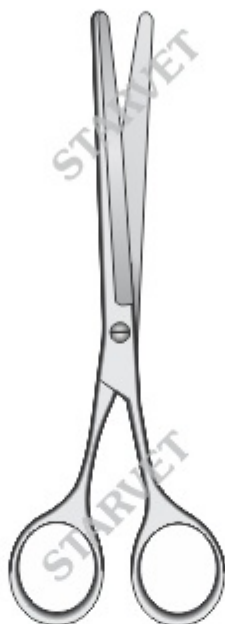

ST06-2430

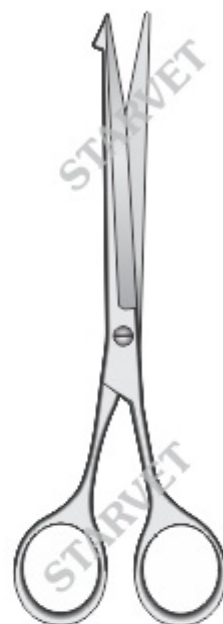

ST06-2440



ST06-2450  
18 cm / 7"



ST06-2460  
18 cm / 7"



ST06-2470



ST06-2480



ST06-2490



ST06-2500

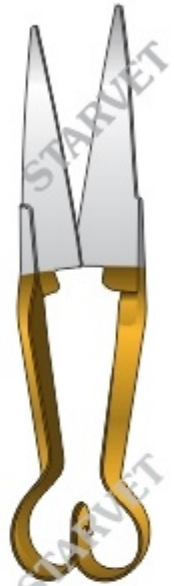

ST06-2510



ST06-2520  
Small, Straight



ST06-2530  
Small, Angled



ST06-2540  
Large, Angled



ST06-2550  
Large, Straight



ST06-2560

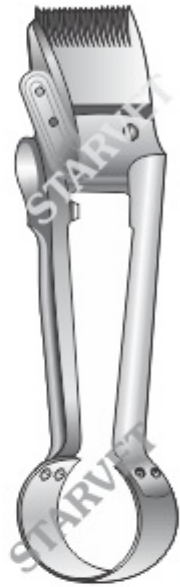

ST06-2570  
25 cm / 9 3/4"  
For Sheep

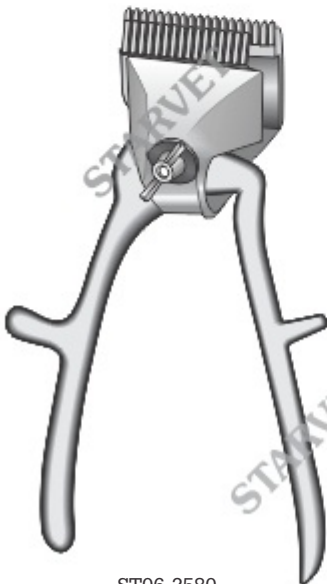

ST06-2580  
For Dogs



ST06-2590





ST06-2600



ST06-2610  
20 cm / 8"  
Wide toothed



ST06-2620  
18 cm / 7"  
Narrow and wide toothed



ST06-2630  
Dog Combs



ST06-2640



ST06-2650



ST06-2660



ST07-0001  
205 mm x 145 mm x 30 mm  
Open View of Box



ST07-0001  
Closed View of Box

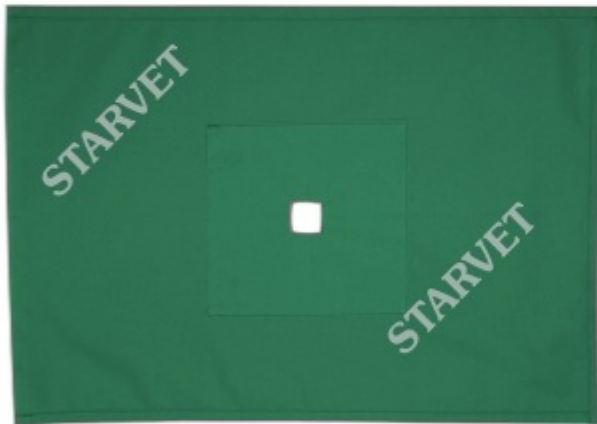

ST07-0005  
Fenestrated Drape

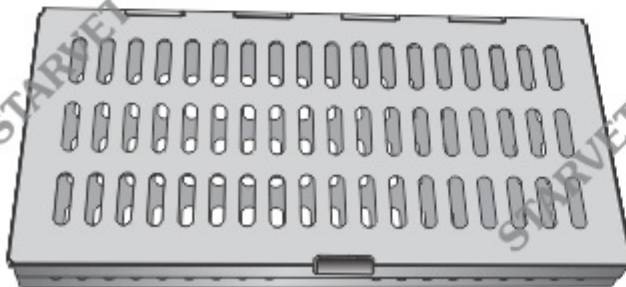

ST07-0010  
Closed View of Box

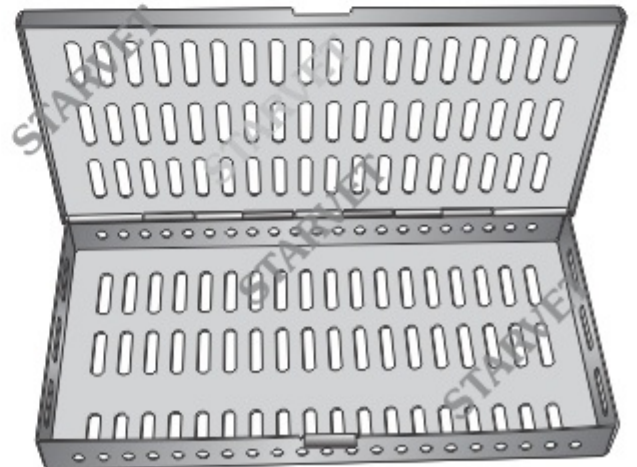

ST07-0010  
255 mm x 130 mm x 25 mm  
Open View

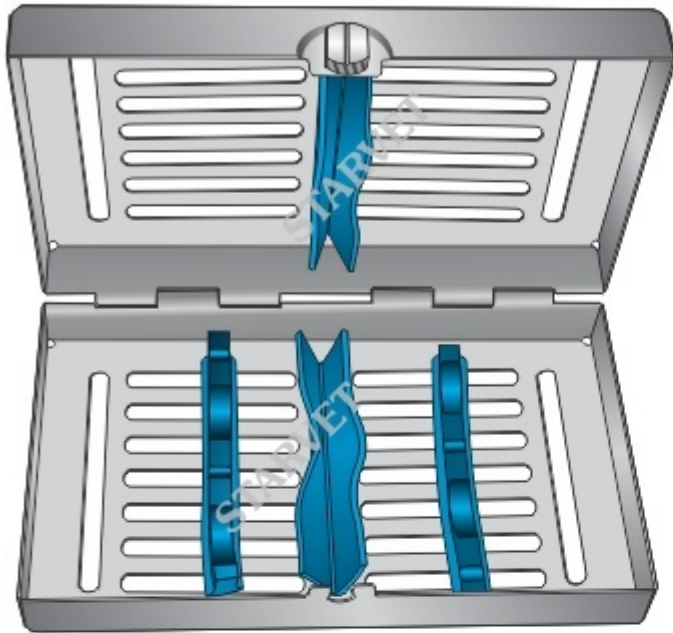

ST07-0020  
285 mm x 105 mm x 35 mm  
Open view of Box

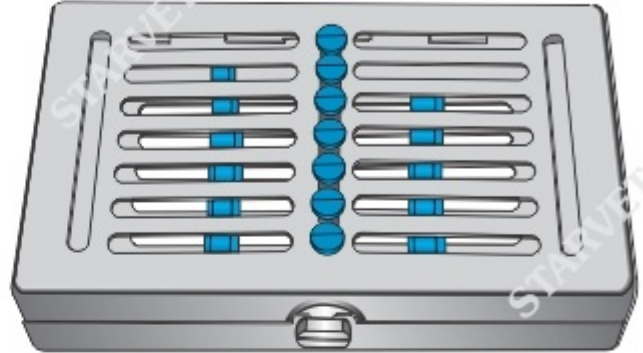

ST07-0020  
Closed View of Box



ST07-0030  
Closed View of Box



ST07-0030  
180 mm x 145 mm x 35 mm  
Open View of Box

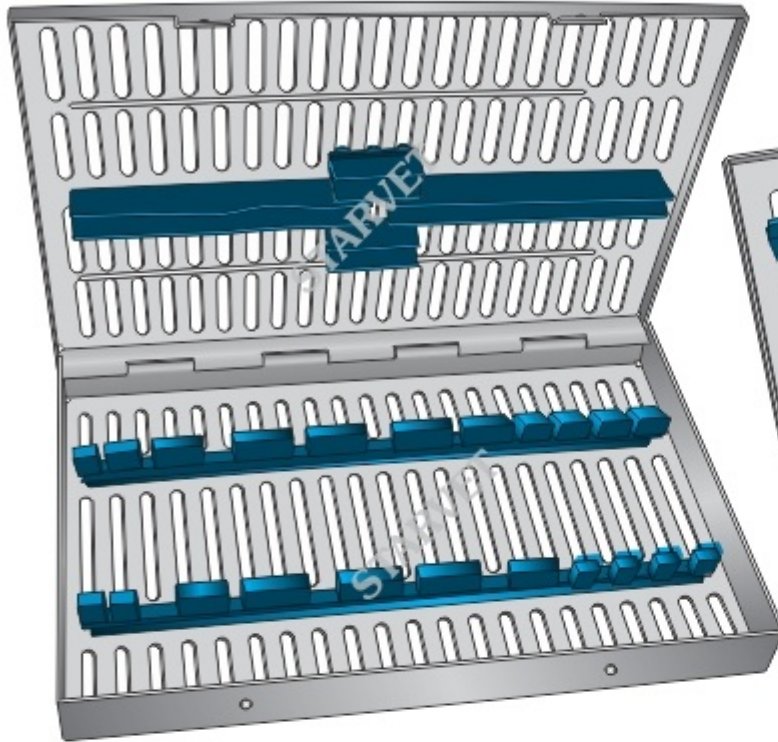

ST07-0040 With Silicon Insert  
285 mm x 185 mm x 35 mm  
Open View of Box

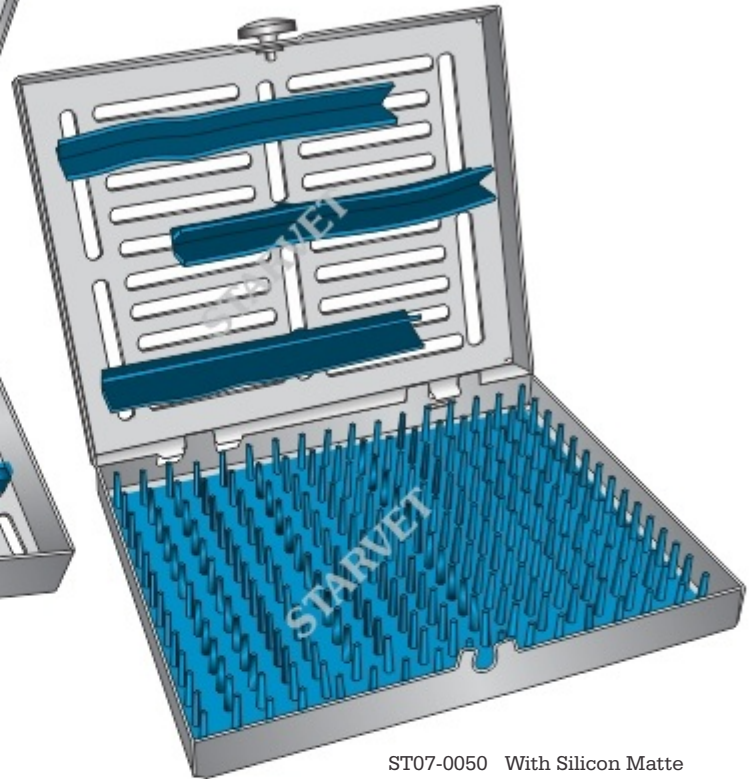

ST07-0050 With Silicon Matte  
285 mm x 185 mm x 35 mm  
Open View of Box

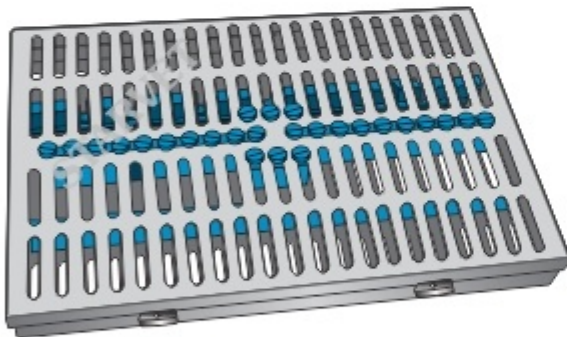

ST07-0040 & ST07-0041  
Closed View of Box



ST07-0060 & ST07-0061  
Closed View of Box

ST07-0060 290 mm x 230 mm x 35 mm  
ST07-0061 30 mm x 200 mm x 40 mm  
Open View of Box

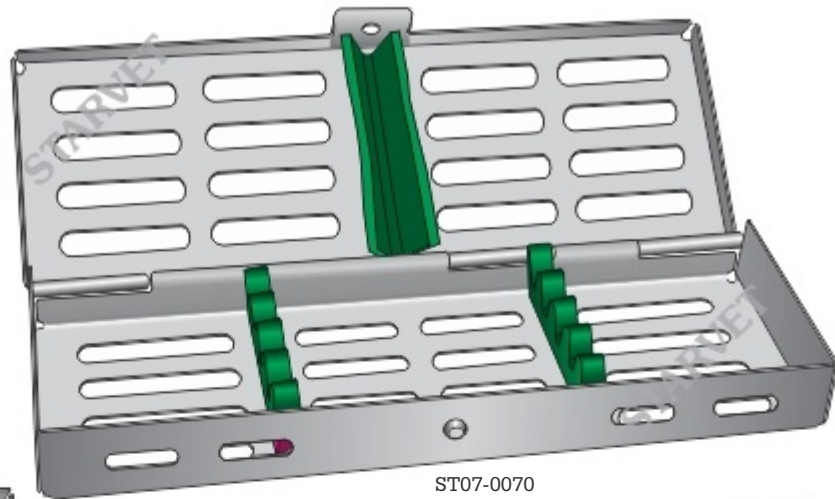

ST07-0070  
185 mm x 65 mm x 20 mm

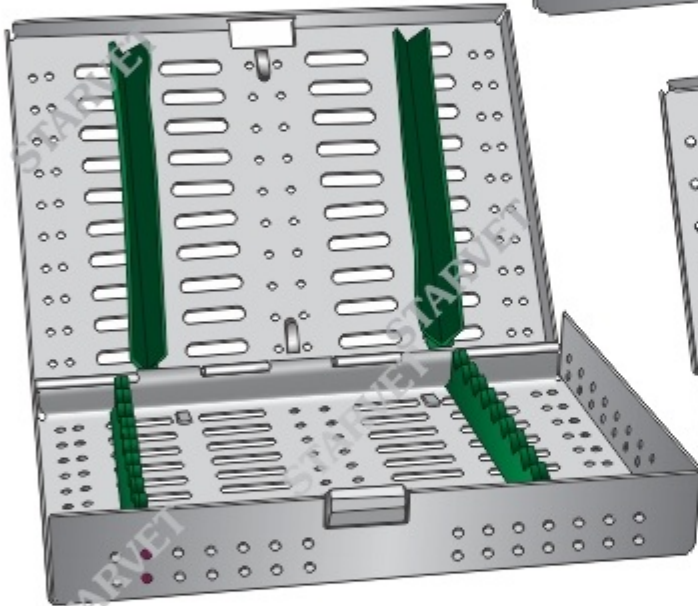

ST07-0080  
180 mm x 160 mm x 60 mm

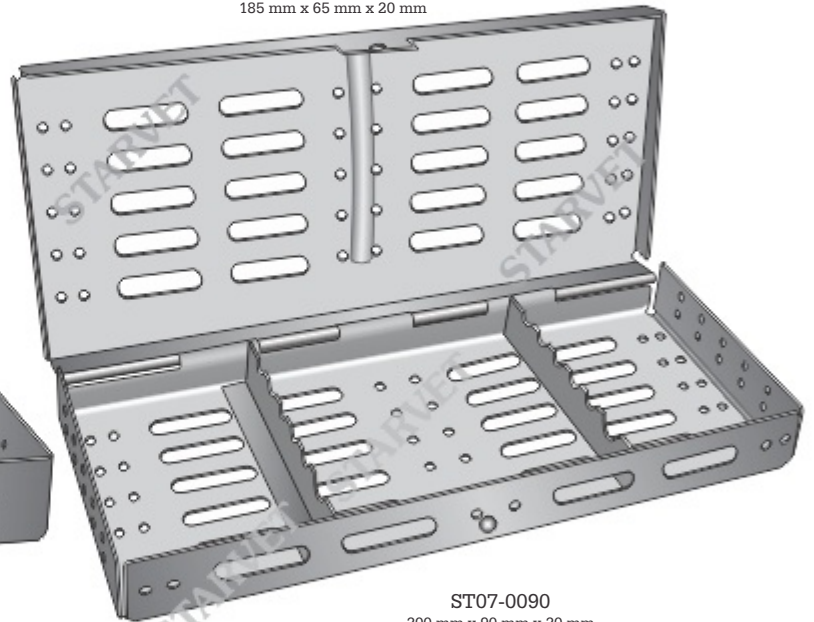

ST07-0090  
200 mm x 90 mm x 20 mm

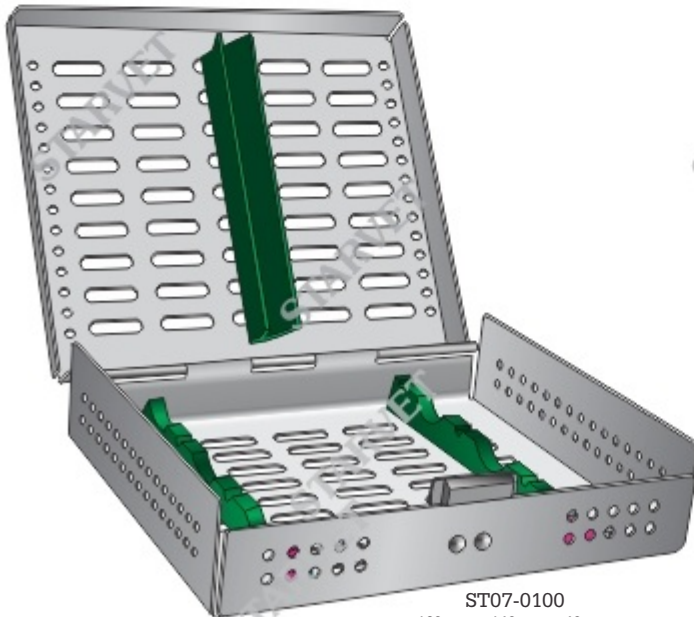

ST07-0100  
160 mm x 140 mm x 40 mm

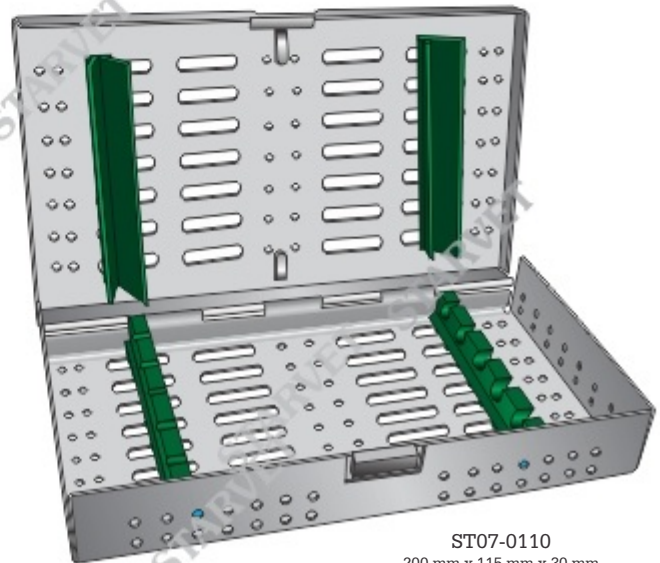

ST07-0110  
200 mm x 115 mm x 30 mm

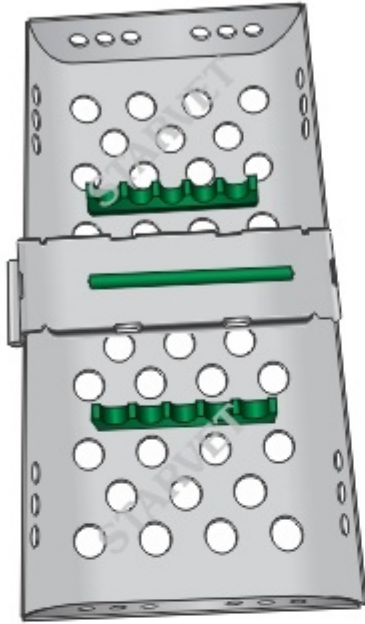

ST07-0120

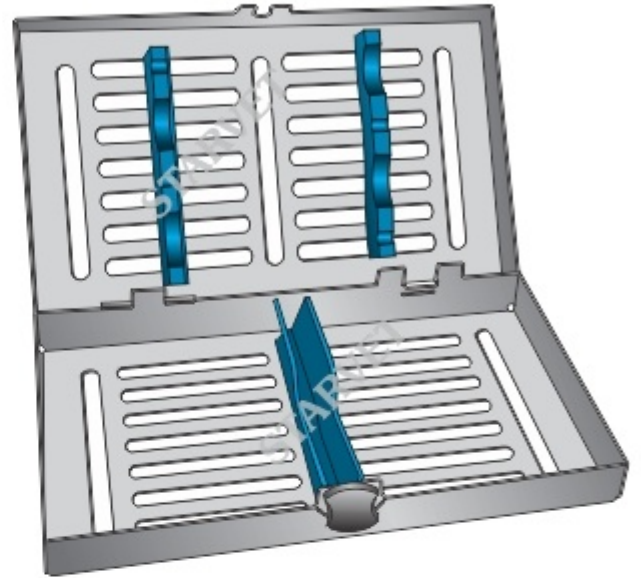

ST07-0130  
185 mm x 105 mm x 35 mm



ST07-0140



ST07-0150  
185 mm x 105 mm x 35 mm

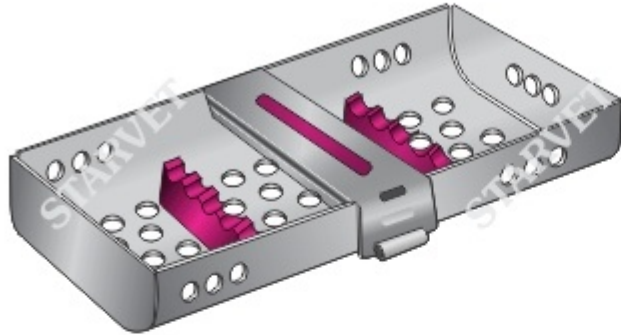

**ST07-0160**  
Strip Lock Tray For 5 Instruments  
185 mm x 90 mm x 23 mm  
Round Bottom

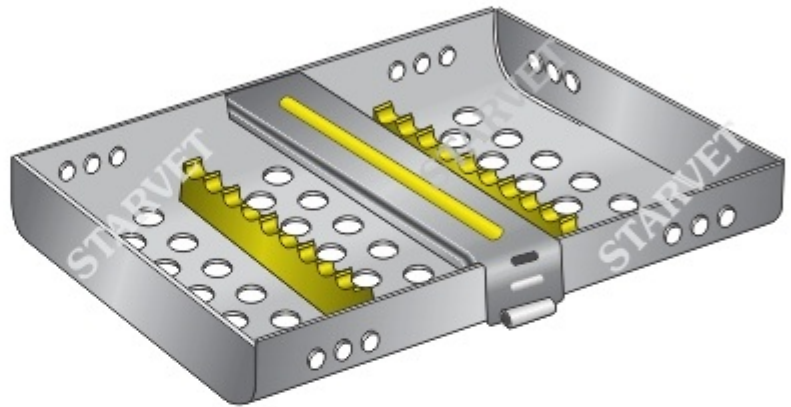

**ST07-0170**  
Strip Lock Tray For 10 Instruments  
185 mm x 145 mm x 23 mm  
Round Bottom

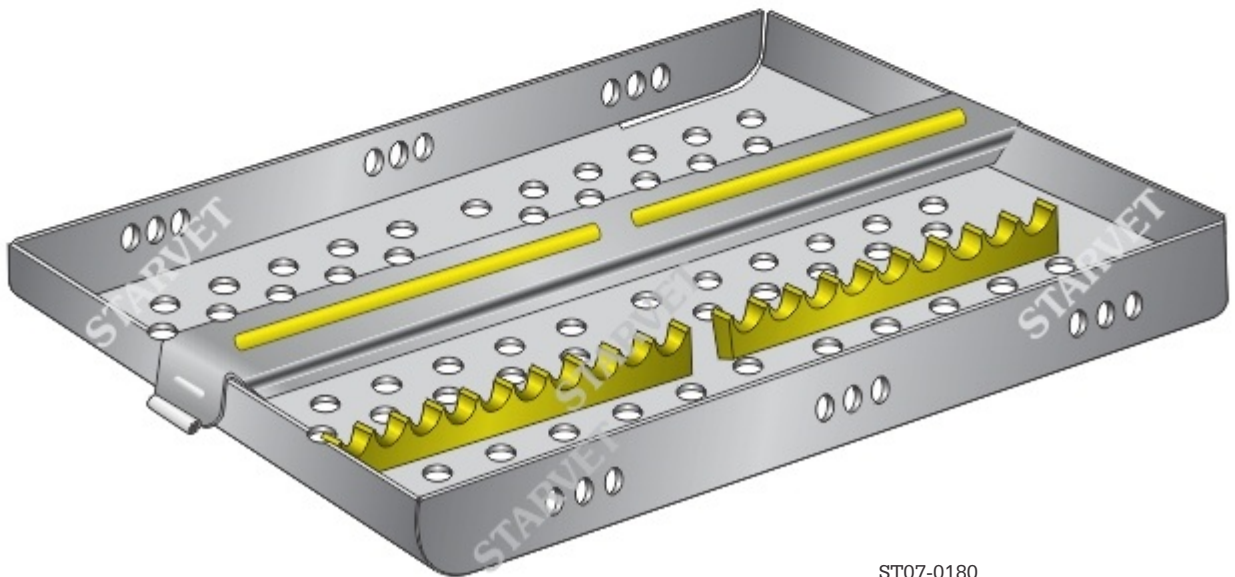

**ST07-0180**  
Strip Lock Tray For 20 Instruments  
265 mm x 185 mm x 23 mm  
Round Bottom

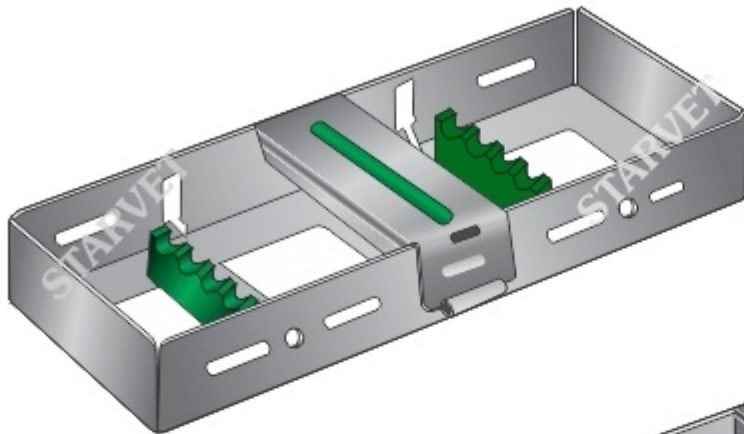

ST07-0190  
Strip Lock Tray For 5 Instruments  
178 mm x 78 mm x 22 mm

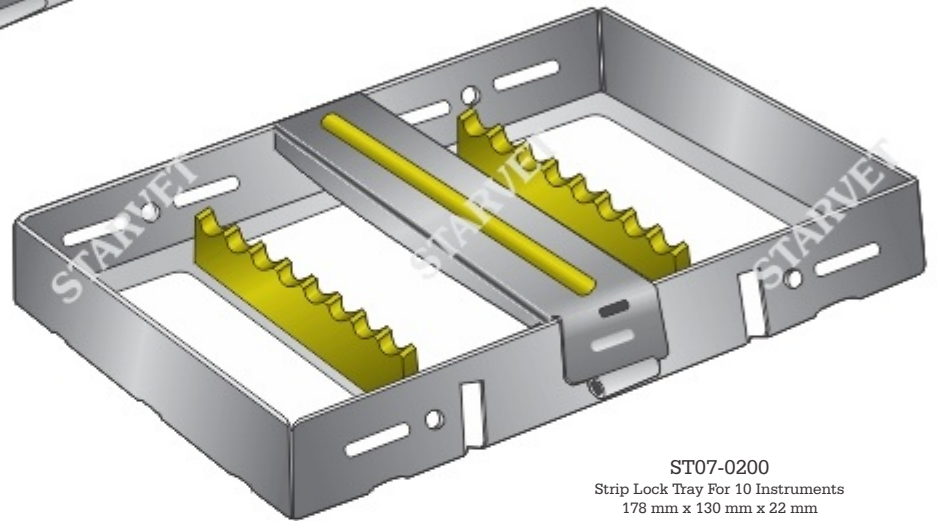

ST07-0200  
Strip Lock Tray For 10 Instruments  
178 mm x 130 mm x 22 mm

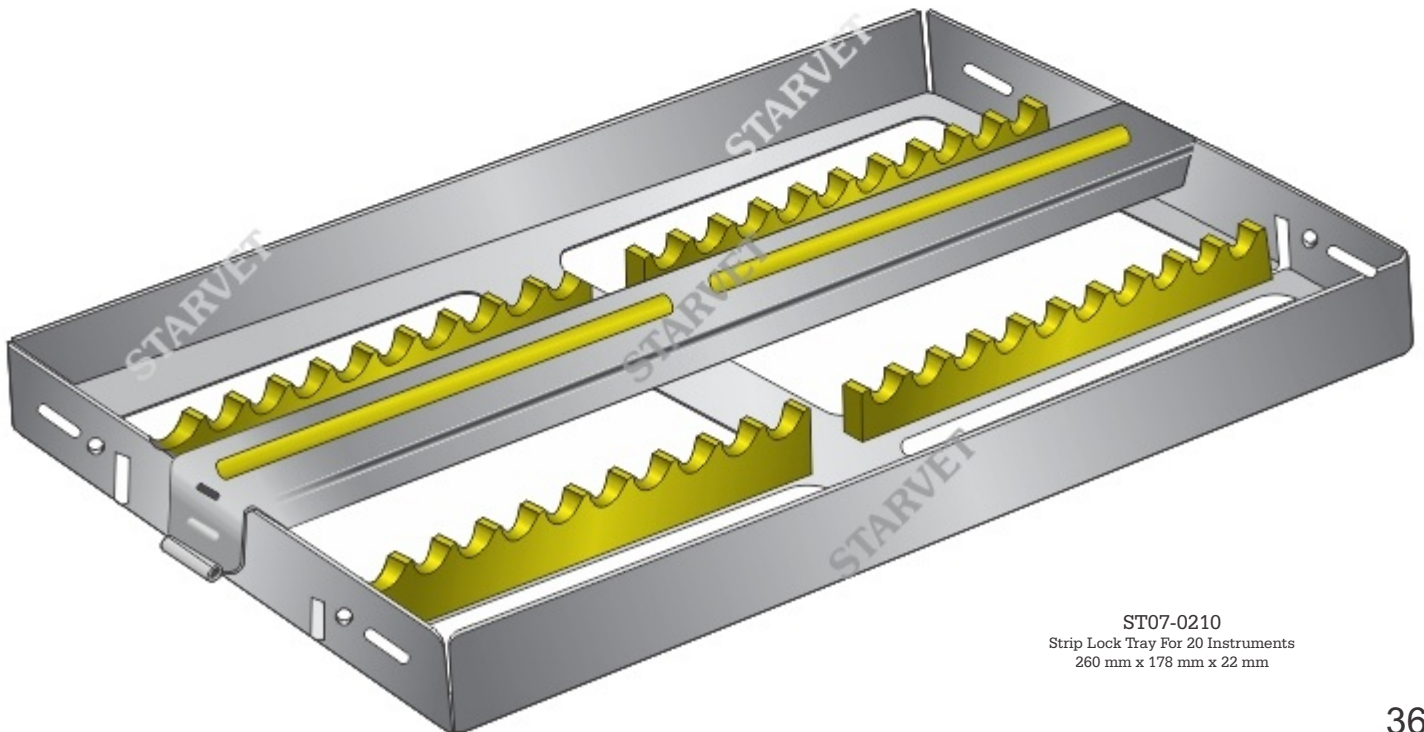

ST07-0210  
Strip Lock Tray For 20 Instruments  
260 mm x 178 mm x 22 mm





ST07-0220 50 x 25 x 4.5 mm  
 ST07-0221 65 x 42 x 8 mm  
 ST07-0222 75 x 25 x 4.5 mm



ST07-0230 50 x 25 x 4.5 mm  
 ST07-0231 65 x 42 x 8 mm  
 ST07-0232 75 x 25 x 4.5 mm

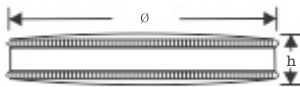
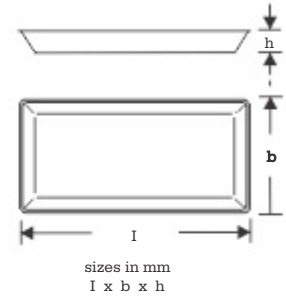

ST07-0240 65 mm diameter  
 Height 15 mm  
 Complete with  
 perforated interior box

ST07-0241 62 mm diameter  
 Height 13 mm  
 Interior box perforated  
 lid and bottom



ST07-0250  
 135 x 100 x 25 mm



ST07-0260 dia x height  
 100 x 20 mm, Dish & Lid  
 ST07-0261 96 x 20 mm, Dish only  
 ST07-0262 100 x 16 mm, Lid only

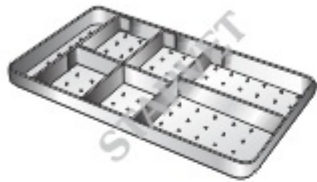

**ST07-0270**  
150 x 95 x 11 mm  
Perforated bottom  
Needle tray



**ST07-0280**  
150 x 95 x 13 mm



**ST07-0290**  
150 x 95 x 13 mm  
Perforated lid and bottom



**ST07-0300**  
150 x 95 x 13 mm  
Perforated lid and bottom



**ST07-0310**  
150 x 95 x 13 mm  
Perforated bottom



**ST07-0320**  
150 x 95 x 13 mm  
Perforated lid and bottom



**ST07-0330**  
150 x 95 x 13 mm

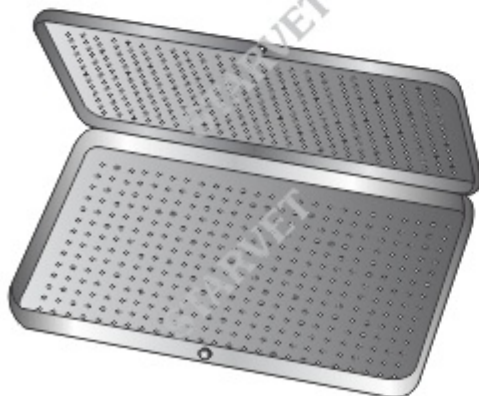

**Sauerbruch**  
**ST07-0340**  
210 x 125 x 17 mm  
Perforated lid and bottom



**Sauerbruch**  
**ST07-0350**  
210 x 125 x 17 mm  
Perforated lid and bottom

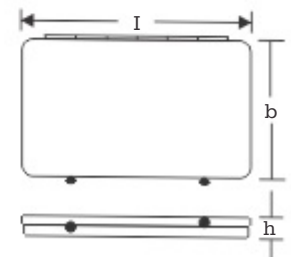

sizes in mm  
l x b x h

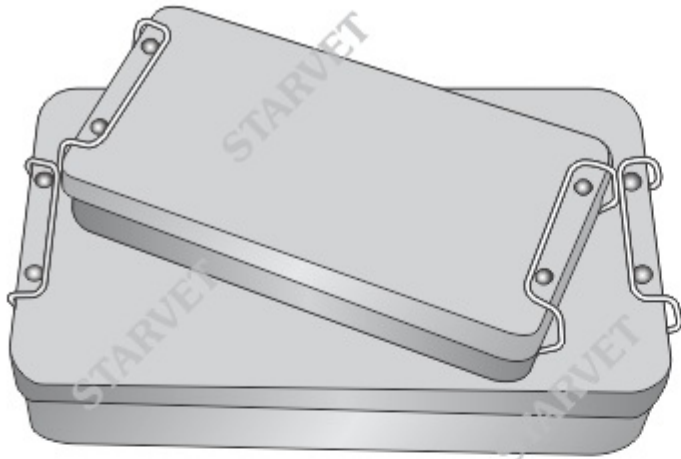

Solid Top & Bottom

Instrument Boxes - Solid Top & Bottom

With side Lock		Without side Lock
ST07-0360	200 x 100 x 40 mm	ST07-0361
ST07-0362	200 x 100 x 40 mm without Filter	ST07-0363
ST07-0364	200 x 120 x 50 mm	ST07-0365
ST07-0366	200 x 120 x 50 mm without Filter	ST07-0367
ST07-0368	200 x 150 x 50 mm	ST07-0369
ST07-0370	280 x 140 x 50 mm	ST07-0371
ST07-0372	280 x 140 x 100 mm without Filter	ST07-0373
ST07-0374	300 x 180 x 30 mm	ST07-0375
ST07-0376	340 x 165 x 50 mm	ST07-0377
ST07-0378	370 x 165 x 70 mm	ST07-0379
ST07-0380	400 x 200 x 70 mm	ST07-0381
ST07-0382	Filter (State Size Of Box)	

Stainless steel construction with a bacterial filter in the base. The filter allows steam to enter and water vapors to leave but excludes bacteria. Available in a range of sizes to suit most instrument sets and autoclaves. Some sizes are available without filter. Replace filter annually.

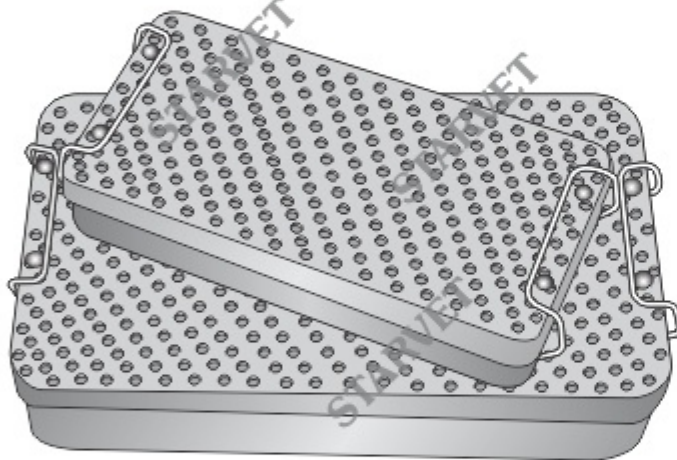

Perforated Top & Solid Bottom

Instrument Boxes - Perforated Top & Solid Bottom

With side Lock		Without side Lock
ST07-0390	200 x 100 x 40 mm	ST07-0391
ST07-0392	200 x 100 x 40 mm Without Filter	ST07-0393
ST07-0394	200 x 120 x 50 mm	ST07-0395
ST07-0396	200 x 120 x 50 mm Without Filter	ST07-0397
ST07-0398	200 x 150 x 50 mm	ST07-0399
ST07-0400	280 x 140 x 50 mm	ST07-0401
ST07-0402	280 x 140 x 100 mm Without Filter	ST07-0403
ST07-0404	300 x 180 x 30 mm	ST07-0405
ST07-0406	340 x 165 x 50 mm	ST07-0407
ST07-0408	370 x 165 x 70 mm	ST07-0409
ST07-0410	400 x 200 x 70 mm	ST07-0411
ST07-0412	Filter (State Size Of Box)	ST07-0413

Stainless steel construction with a bacterial filter in the base. The filter allows steam to enter and water vapors to leave but excludes bacteria. Available in a range of sizes to suit most instrument sets and autoclaves. Some sizes are available without filter. Replace filter annually.

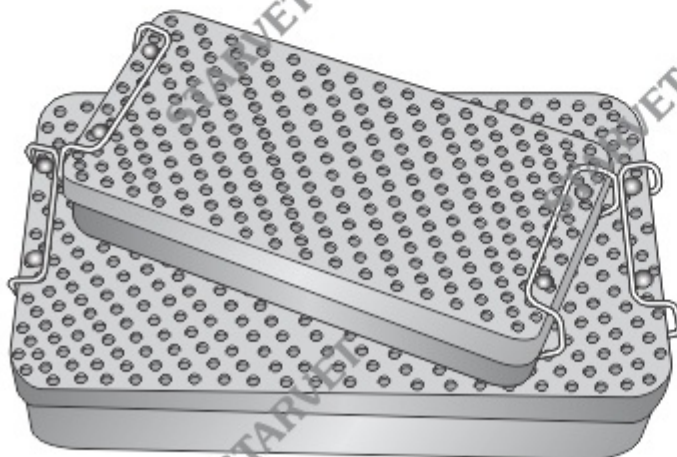

Perforated Top & Bottom

Instrument Boxes - Perforated Top & Bottom

With side Lock		Without side Lock
ST07-0420	200 x 100 x 40 mm	ST07-0421
ST07-0422	200 x 100 x 40 mm Without Filter	ST07-0423
ST07-0424	200 x 120 x 50 mm	ST07-0425
ST07-0426	200 x 120 x 50 mm Without Filter	ST07-0427
ST07-0428	200 x 150 x 50 mm	ST07-0429
ST07-0430	280 x 140 x 50 mm	ST07-0431
ST07-0432	280 x 140 x 100 mm Without Filter	ST07-0433
ST07-0434	300 x 180 x 30 mm	ST07-0435
ST07-0436	340 x 165 x 50 mm	ST07-0437
ST07-0438	370 x 165 x 70 mm	ST07-0439
ST07-0440	400 x 200 x 70 mm	ST07-0441
ST07-0442	Filter (State Size Of Box)	ST07-0443

Stainless steel construction with a bacterial filter in the base. The filter allows steam to enter and water vapors to leave but excludes bacteria. Available in a range of sizes to suit most instrument sets and autoclaves. Some sizes are available without filter. Replace filter annually.



Schimmelbusch

	Ø x h
ST07-0450	80 x 80 mm
ST07-0451	120 x 120 mm
ST07-0452	140 x 140 mm
ST07-0453	160 x 120 mm
ST07-0454	160 x 150 mm
ST07-0455	190 x 150 mm
ST07-0456	190 x 190 mm
ST07-0457	240 x 160 mm
ST07-0458	240 x 240 mm
ST07-0459	290 x 160 mm
ST07-0460	240 x 240 mm
ST07-0461	340 x 160 mm
ST07-0462	340 x 240 mm
ST07-0463	390 x 190 mm
ST07-0464	390 x 290 mm

Konrich

	Ø x h
ST07-0470	100 x 100 mm
ST07-0471	150 x 150 mm
ST07-0472	200 x 150 mm
ST07-0473	200 x 190 mm
ST07-0474	240 x 160 mm
ST07-0475	240 x 230 mm
ST07-0476	290 x 160 mm
ST07-0477	290 x 240 mm
ST07-0478	340 x 160 mm
ST07-0479	340 x 240 mm
ST07-0480	390 x 145 mm
ST07-0481	390 x 240 mm
ST07-0482	390 x 290 mm

Set of special filters ( 5 pairs)

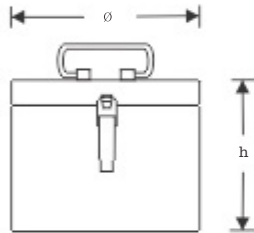

ST07-0500	240 x 240 x 50 mm
ST07-0501	240 x 240 x 80 mm
ST07-0502	240 x 240 x 100 mm
ST07-0503	480 x 260 x 50 mm
ST07-0504	520 x 260 x 80 mm
ST07-0505	520 x 260 x 100 mm

Sterilizing Tray Of Perforated Steel Sheet

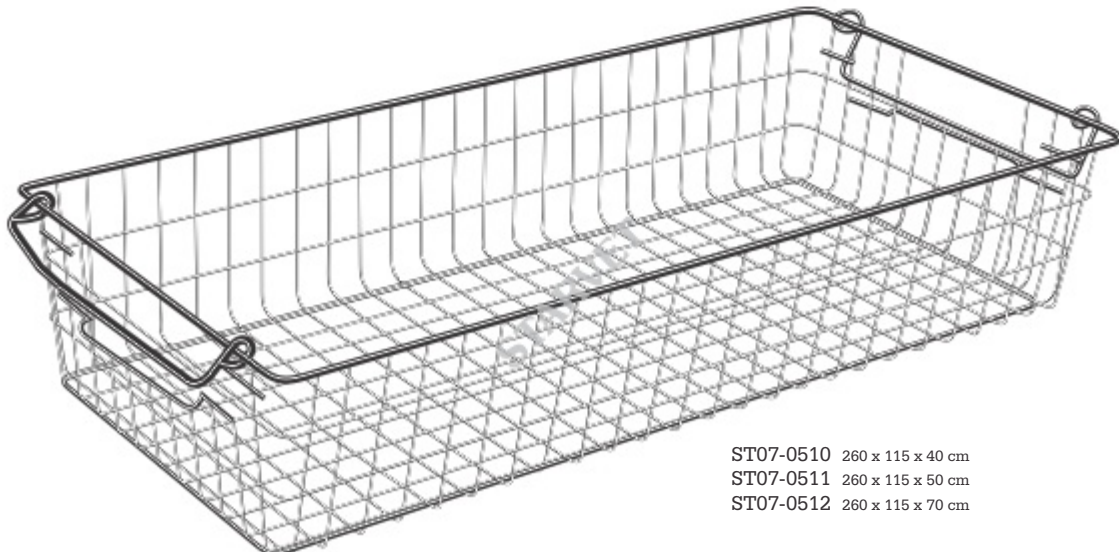

ST07-0510	260 x 115 x 40 cm
ST07-0511	260 x 115 x 50 cm
ST07-0512	260 x 115 x 70 cm



ST07-0520 0.25 L  
ST07-0521 0.50 L  
ST07-0522 1.00 L  
ST07-0523 2.00 L  
Graduated inside



	Ø x h	Capacity
ST07-0530	40 x 19 mm	0.05 oz
ST07-0531	61 x 30 mm	0.07 oz
ST07-0532	80 x 40 mm	0.14 oz
ST07-0533	100 x 50 mm	0.35 oz
ST07-0534	120 x 55 mm	0.45 oz
ST07-0535	140 x 65 mm	0.7 oz
ST07-0536	150 x 75 mm	1.1 oz
ST07-0537	180 x 85 mm	1.6 oz



ST07-0550  
220 mm x 70 mm



Bowl	Ø x h	Capacity
ST07-0560	100 x 35 mm	0.3 oz
ST07-0561	120 x 38 mm	0.4 oz
ST07-0562	140 x 40 mm	0.5 oz
ST07-0563	150 x 45 mm	0.75 oz
ST07-0564	180 x 45 mm	1.0 oz
ST07-0565	300 x 90 mm	3.0 oz
ST07-0566	350 x 115 mm	5.0 oz



Galipot	Capacity
ST07-0580	30 ml, 1 oz
ST07-0581	60 ml, 2 oz
ST07-0582	90 ml, 3 oz
ST07-0583	120 ml, 4 oz
ST07-0584	150 ml, 5 oz
ST07-0585	180 ml, 6 oz
ST07-0586	210 ml, 7 oz
ST07-0587	240 ml, 8 oz
ST07-0588	270 ml, 9 oz
ST07-0589	300 ml, 10 oz
ST07-0590	330 ml, 11 oz
ST07-0591	360 ml, 12 oz
ST07-0592	420 ml, 13 oz
ST07-0593	450 ml, 14 oz



	Ø x h	Capacity
ST07-0600	116 x 35 mm	0.3 oz
ST07-0601	128 x 38 mm	0.4 oz
ST07-0602	147 x 40 mm	0.5 oz
ST07-0603	157 x 45 mm	0.75 oz
ST07-0604	187 x 45 mm	1.0 oz



ST07-0610 170 x 100 x 35 mm  
ST07-0611 250 x 140 x 40 mm  
ST07-0612 275 x 150 x 45 mm



ST07-0620  
250 x 140 x 40 mm  
Lid for kidney dish

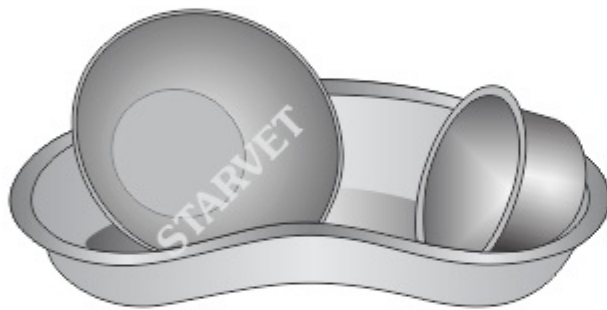
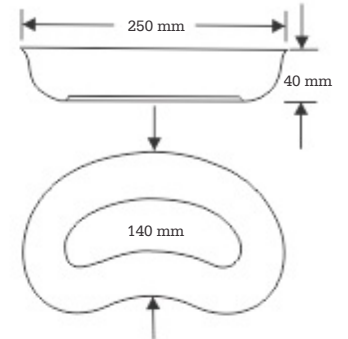

Holloware

- ST07-0630 15 cm / 6", Kidney Dish
- ST07-0631 20 cm / 8", Kidney Dish
- ST07-0632 25.5 cm / 10", Kidney Dish
- ST07-0633 30.5 cm / 12", Kidney Dish
- ST07-0634 10 cm / 4", Lotion Bowl
- ST07-0635 15 cm / 6", Lotion Bowl
- ST07-0636 20 cm / 8", Lotion Bowl
- ST07-0637 25.5 cm / 10", Lotion Bowl



ST07-0650

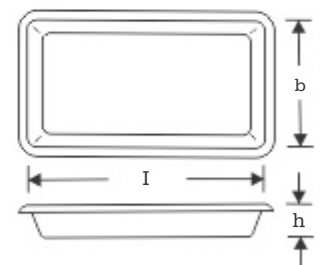

- |           | l x b x h         |
|-----------|-------------------|
| ST07-0660 | 230 x 155 x 30 mm |
| ST07-0661 | 300 x 200 x 30 mm |
| ST07-0662 | 300 x 200 x 40 mm |
| ST07-0663 | 350 x 250 x 36 mm |
| ST07-0664 | 400 x 300 x 50 mm |





Instrument Tray	
ST07-0670	200 x 150 x 10 mm
ST07-0672	235 x 190 x 40 mm
ST07-0674	250 x 200 x 10 mm
ST07-0676	300 x 150 x 10 mm
ST07-0678	350 x 200 x 10 mm
ST07-0680	350 x 250 x 10 mm
ST07-0682	400 x 200 x 10 mm
ST07-0684	450 x 300 x 10 mm
ST07-0686	230 x 155 x 30 mm
ST07-0688	300 x 200 x 30 mm
ST07-0690	300 x 200 x 40 mm
ST07-0692	350 x 250 x 36 mm
ST07-0694	400 x 300 x 50 mm



Tray with Lid	
ST07-0671	
ST07-0673	
ST07-0675	
ST07-0677	
ST07-0679	
ST07-0681	
ST07-0683	
ST07-0685	
ST07-0687	
ST07-0689	
ST07-0691	
ST07-0693	
ST07-0695	



Lid With Handle



Lid Without Handle

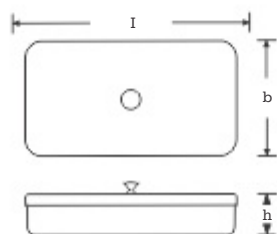

With Handle	Without Handle	I x b x h
ST07-0700	ST07-0701	150 x 80 x 35 mm
ST07-0703	ST07-0704	200 x 100 x 35 mm
ST07-0706	ST07-0707	200 x 100 x 50 mm
ST07-0709	ST07-0710	230 x 130 x 50 mm
ST07-0712	ST07-0713	240 x 150 x 50 mm
ST07-0715	ST07-0716	300 x 250 x 50 mm
ST07-0718	ST07-0719	300 x 200 x 50 mm
ST07-0721	ST07-0722	325 x 275 x 50 mm



with side lock

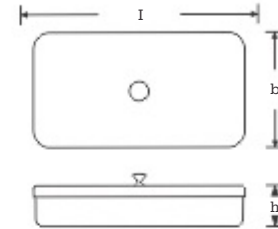

With side Lock	l x b x h
ST07-0730	150 x 80 x 35 mm
ST07-0731	200 x 100 x 35 mm
ST07-0732	200 x 100 x 50 mm
ST07-0733	230 x 130 x 50 mm
ST07-0734	240 x 150 x 50 mm
ST07-0735	300 x 250 x 50 mm
ST07-0736	300 x 200 x 50 mm
ST07-0737	325 x 275 x 50 mm

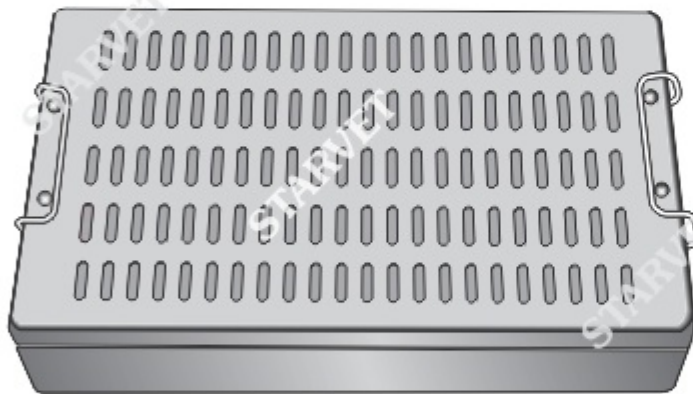

Instrument boxes with filter

ST07-0750	200 x 100 x 40 mm
ST07-0751	220 x 120 x 50 mm
ST07-0752	220 x 150 x 50 mm
ST07-0753	250 x 150 x 60 mm
ST07-0754	280 x 140 x 50 mm
ST07-0755	280 x 140 x 100 mm
ST07-0756	340 x 165 x 50 mm
ST07-0757	340 x 165 x 70 mm
ST07-0758	400 x 200 x 70 mm

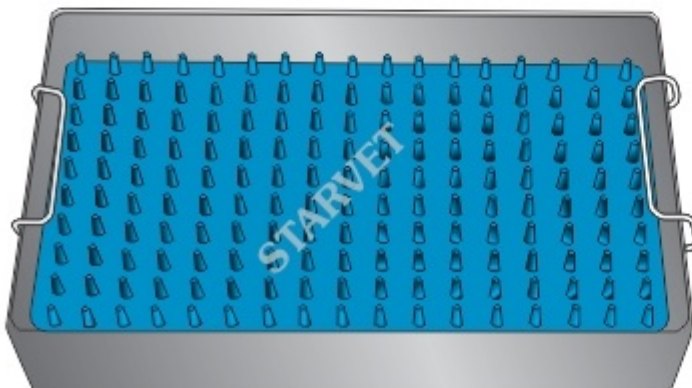

Instrument boxes without filter

ST07-0770	200 x 100 x 40 mm
ST07-0771	220 x 120 x 50 mm
ST07-0772	220 x 150 x 50 mm
ST07-0773	250 x 150 x 60 mm
ST07-0774	280 x 140 x 50 mm
ST07-0775	280 x 140 x 100 mm
ST07-0776	340 x 165 x 50 mm
ST07-0777	340 x 165 x 70 mm
ST07-0778	400 x 200 x 70 mm



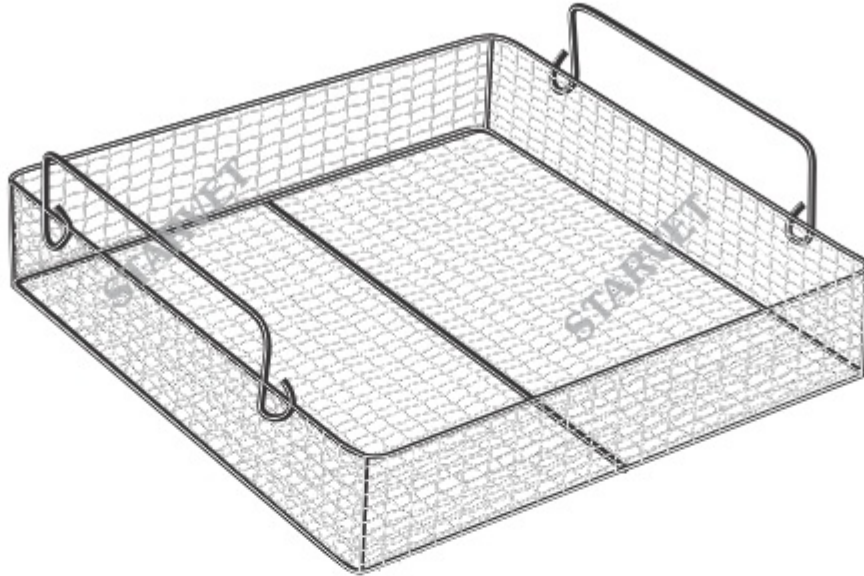

**Premium Box Baskets**

ST07-0780 480 x 250 x 50 mm

ST07-0781 520 x 250 x 75 mm

ST07-0782 520 x 250 x 100 mm

Sterilizing Tray Of Wire Mesh For Container 60 cm long

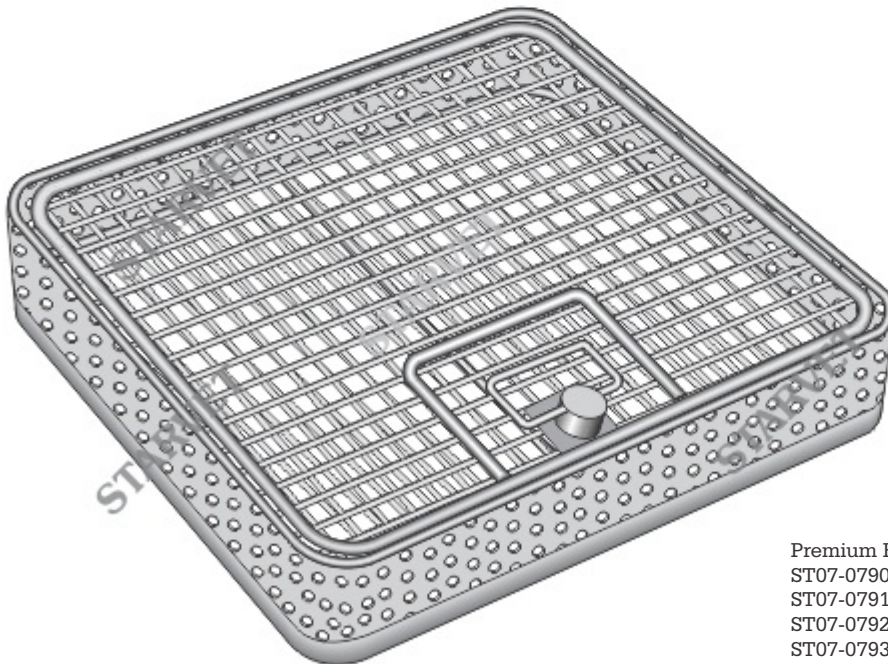

**Premium Box Baskets**

ST07-0790 260 x 115 x 70 mm

ST07-0791 260 x 115 x 50 mm

ST07-0792 260 x 115 x 40 mm

ST07-0793 140 x 140 x 50 mm

ST07-0794 140 x 145 x 25 mm

With lid & accessories



ST07-0800 25 cm / 10"  
ST07-0801 32 cm / 12¾"  
With Ratchet



ST07-0810 25 cm / 10"  
ST07-0811 32 cm / 12¾"  
Without Ratchet



Modell  
ST07-0820  
58 cm / 22¾"



Sauerbruch  
ST07-0830  
55 cm / 21½"



Cheattle  
ST07-0840  
26.5 cm / 10½"



Cheattle  
ST07-0850  
27 cm / 10½"

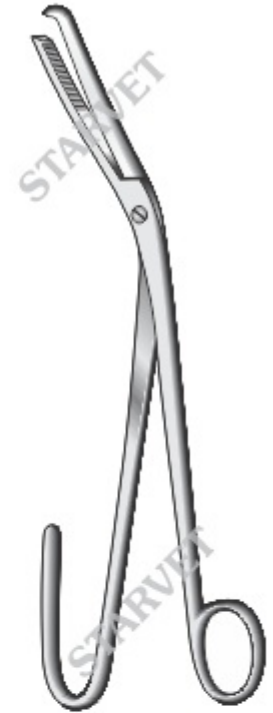

Cheattle  
ST07-0860  
28 cm / 11"



Pye-Smith-Harrison  
ST07-0870 25 cm / 10"  
ST07-0871 30 cm / 12"



Harrison  
ST07-0880 25 cm / 10"  
ST07-0881 30 cm / 12"  
ST07-0882 35 cm / 14"  
ST07-0883 45 cm / 18"

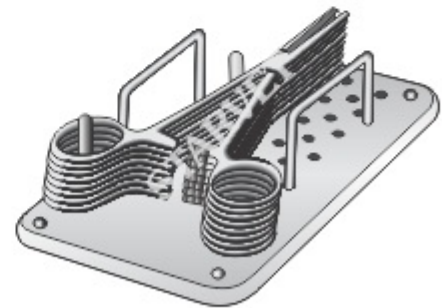

ST07-0890

# Instrument kits & Sets

Instrument  
**Kits & Sets**

## All Instruments Sets Are Available In A Case Of Your Choice.

You Can Make A Choice From Below.

1. Leather Pouches
2. Economy Perforated Stainless Steel Boxes
3. Premium Perforated Stainless Steel Boxes With Silicon Mats.
4. Stainless Steel Cassettes With Silicon Or Stainless Steel Fittings.

**Cat Spay Kit ST10-001**

S. No.	Page No.	Item No.	Description	Quantity
1	37	ST02-2051	Spencer-Wells Artery Forceps, 12.5 cm / 5", Curved	2
2	32	ST02-1741	Adson Dissecting Forceps, 1 x 2 Teeth, 12 cm / 4¾"	1
3	34	ST02-1905	Halstead-Mosquito Forceps, Curved, 12 cm / 4¾"	2
4	14	ST02-0400	Metzenbaum Scissors, Straight, 14 cm / 5½"	1
5	95	ST02-5060	Olsen-Hegar Needle Holders T.C, 14 cm / 5½"	1
6	30	ST02-1650	Spay Forceps - 120 mm	1
7	49	ST 02-2571	Jones Towel Clamp, 9 cm / 3½"	4
8	7	ST02-0010	Scalpel Handle With Scale No. 3	1

**Feline Spay Kit ST10-002**

S. No.	Page No.	Item No.	Description	Quantity
1	14	ST02-0400	Metz Scissor, 14.5 cm / 5½", Straight	1
2	30	ST02-1650	Sturdy Type Spay Forceps	1
3	32	ST02-1741	Adson Rat Tooth Forceps, 1 x 2 Teeth, 12 cm / 4¾"	1
4	34	ST02-1902	Halsted-Mosquito Forceps, 10 cm / 4"	2
5	359	ST07-0005	Fenestrated Drape	1
6	49	ST02-2570	Cross Action Towel Clips, 5 cm / 2"	2
7	90	ST02-4791	Olsen-Hegar, 16 cm / 6¼"	1
8	37	ST02-2052	Spencer Wells, 15 cm / 5", Straight	2
9	7	ST02-0001	Standard Scalpel Handle No. 3, Solid	1
10	368	ST07-0430	Instrument Case : Make your choice from page no 378	1

**Feline Spay - Cat Spay Kit ST10-003**

S. No.	Page No.	Item No.	Description	Quantity
1	13	ST02-0324	Mayo Scissors 6¾" Straight, 17 cm / 6¾"	1
2	7	ST02-0001	Scalpel/blade Handle No. 3, solid	1
3	71	ST02-3721	Snook Hook, 20 cm / 8"	1
4	35	ST02-1961	Kelly Hemostat Forceps, 14 cm / 5½", Curved	2
5	14	ST02-0401	Metzenbaum Scissor, 14 cm / 5½", Curved	1
6	27	ST02-1366	Tissue Forceps, 14 cm / 5½", 1 x 2 Teeth	1
7	44	ST02-2380	Allis Forceps, 15 cm / 6", 4 x 5 Teeth	1
8	49	ST02-2600	Backhaus Towel Clamps, 9 cm / 3½"	4
9	30	ST02-1610	Adson-Brown Forceps 12 cm / 4¾", 7 x 7 Teeth	1
10	90	ST02-4790	Olsen-Hegar Needle Holder, 14 cm / 5½"	1
11	34	ST02-1907	Halstead-Mosquito Forceps, 12.5 cm / 5", Curved	2
12	39	ST02-2193	Rochester-Carmalt Forceps, 16 cm / 6¼", Curved	2

**Feline Spay - Cat Spay Kit ST10-004**

S. No.	Page No.	Item No.	Description	Quantity
1	35	ST02-1961	Kelly Hemostatic Forceps, 14 cm / 5½", Curved	2
2	35	ST02-1960	Kelly Hemostatic Forceps, 14 cm / 5½", Straight	2
3	34	ST02-1907	Mosquito Forceps, 12.5 cm / 5", Curved	2
4	34	ST02-1906	Mosquito Forceps, 12.5 cm / 5", Straight	2
5	49	ST02-2571	Jones Towel Clamp, 9 cm / 3½"	3
6	27	ST02-1326	Dressing Forceps, 14.5 cm / 5½"	2
7	7	ST02-0001	Standard Scalpel Handle No. 3, Solid	1
8	32	ST02-1760	Adson - Brown Forceps, 12 cm / 4¾"	1
9	23	ST02-0950	TC Mayo Scissors, 15 cm / 6", Straight	1
10	93	ST02-4972	TC Mayo-Hegar Needle Holder, 18 cm / 7"	1

S. No.	Page No.	Item No.	Description	Quantity
11	95	ST02-5062	Olsen-Hegar Needle Holder TC , 17 cm / 6¾"	1
12	71	ST02-3680	Spay Hook, 13 cm / 5"	1

### ST10-005 Cat Spay Kit

S. No.	Page No.	Item No.	Description	Quantity
1	7	ST02-0001	Scalpel Handle No.3 Solid Standard	1
2	49	ST02-2600	Backhaus Towel Forceps, 9 cm / 3½"	4
3	27	ST02-1320	Standard Dressing Forceps, 10 cm / 4"	1
4	27	ST02-1360	Standard Tissue Forceps, 10 cm / 4", 1 x 2 Teeth	1
5	13	ST02-0320	Mayo Scissors, 14 cm / 5¾", Straight	1
6	34	ST02-1907	Halsted-Mosquito Artery Forceps, 12.5 cm / 5", Curved	2
7	34	ST02-1906	Halsted-Mosquito Artery Forceps, 12.5 cm / 5", Straight	2
8	38	ST02-2091	Rochester-Pean Artery Forceps, 14 cm / 5½", Curved	1
9	38	ST02-2090	Rochester-Pean Artery Forceps, 14 cm / 5½", Straight	1
10	90	ST02-4790	Olsen-Hegar Needle Holder, 14 cm / 5½"	1
11	44	ST02-2380	Allis Tissue & Holding Forceps, 15 cm / 6", 4 x 5 Teeth	2

### ST10-006 Cat Spay Kit

S. No.	Page No.	Item No.	Description	Quantity
1	34	ST02-1908	Halsted-Mosquito Artery Forceps, 18 cm / 7", Straight	2
2	53	ST02-2862	De Bakey Tissue Forceps, 20 cm / 8", Width 2.5 mm	1
3	32	ST02-1741	Adson Dissecting Forceps, 12 cm / 4¾", 1 x 2 Teeth	1
4	95	ST02-5060	Olsen-Hegar Needle Holder, TC, 14 cm / 5½"	1
5	49	ST02-2590	English Model Towel Forceps, 9 cm / 3½"	4
6	37	ST02-2052	Spencer-Wells Artery Forceps, 15 cm / 6", Straight	2
7	14	ST02-0400	Metzenbaum Dissecting Scissors, 14.5 cm / 5½", Blunt/Blunt	1
8	7	ST02-0001	Standard Scalpel Handle, No.3, Solid	1

### ST10-007 Cat Spay Kit

S. No.	Page No.	Item No.	Description	Quantity
1	34	ST02-1908	Halsted-Mosquito Artery Forceps, 18 cm / 7", Straight	2
2	53	ST02-2862	De Bakey Tissue Forceps, 20 cm / 8", Width 2.5 mm	1
3	32	ST02-1741	Adson Dissecting Forceps, 12 cm / 4¾", 1 x 2 Teeth	1
4	95	ST02-5060	Olsen-Hegar Needle Holder, TC, 14 cm / 5½"	1
5	49	ST02-2590	English Model Towel Forceps, 9 cm / 3½"	4
6	37	ST02-2052	Spencer-wells Artery Forceps, 15 cm / 6", Straight	2
7	14	ST02-0400	Metzenbaum Dissecting Scissors, 14.5 cm / 5½", Blunt/Blunt	1
8	7	ST02-0001	Standard Scalpel Handle No.3, Solid	1
9	378		Instrument Case : Make your choice from page no 378	1

### ST10-008 Hand Scaler kit

S. No.	Page No.	Item No.	Description	Quantity
1	219B	ST04-1580	Goldman-Fox Combination Explorer Probe	2
2	219B	ST04-1585	Towner-Jaquette Periodontia Instrument, Fig. 15/30	1
3	219B	ST04-1592	Gracey Periodontia Instrument, Fig. 13/14	1
4	219B	ST04-1590	Gracey Periodontia Instrument, Fig. 1/2	1
5	219B	ST04-1595	Langer Scaler, Fig. 5/6	4

S. No.	Page No.	Item No.	Description	Quantity
6	219B	ST04-1591	Gracey Periodontia Instrument, Fig. 11/12	2
7	261	ST04-5130	Sharpening Stone, Rodent	1

### Rodent Kit ST10-009

S. No.	Page No.	Item No.	Description	Quantity
1	253	ST04-4540	Mouth Gag Rodent Instrument, White	1
2	260	ST04-5090	Molar Cutter - Tc Gold, Small, 14 cm / 5½"	1
3	260	ST04-5050	Molar Extraction Forceps	1
4	256	ST04-4720	Rodent Spatula	1
5	256	ST04-4700	Rodent Rasps, Medium	1
6	255	ST04-4650	Cheek Spreader, Small	1
7	255	ST04-4652	Cheek Spreader, Large	1
8	260	ST04-5060	Molar Cutter, Small, Rodent	1
9	256	ST04-4740	Rodent Spatula, Small	1
10	256	ST04-4741	Rodent Spatula, Large	1

### Bitch Spay Kit ST10-0010

S. No.	Page No.	Item No.	Description	Quantity
1	35	ST02-1961	kelly Artery Forceps, 14 cm / 5½", Curved	2
2	35	ST02-1960	kelly Artery Forceps, 14 cm / 5½", Straight	1
3	34	ST02-1907	Halsted-Mosquito Artery Forceps, 12.5 cm / 5", Curved	2
4	34	ST02-1906	Halsted-Mosquito Artery, Forceps, 12.5 cm / 5", Straight	2
5	49	ST02-2600	Backhaus Towel Clamps, 9 cm / 3½"	4
6	27	ST02-1326	Standard Dressing Forceps, 14.5 cm / 5½"	1
7	7	ST02-0001	Standard Scalpel Handle No.3, Solid	1
8	32	ST02-1760	Adson-Brown Dissecting Forceps, 12 cm / 4¾"	1
9	22	ST02-0922	Mayo Scissors TC, 17 cm / 6¾", Straight	1
10	89	ST02-4742	Mayo-Hegar Needle holder, 18 cm / 7"	1
11	95	ST02-5062	Olsen-Hegar Needle holder, TC, 17 cm / 6¾"	1
12	30	ST02-1610	Adson-Brown Forceps, 7 x 7 Teeth, 12 cm / 4¾"	1
13	71	ST02-3720	Covault Hooks, 16 cm / 6½"	1

### Canine - Spay Kit ST10-0011

S. No.	Page No.	Item No.	Description	Quantity
1	7	ST02-0001	Standard Scalpel Handle No.3, Solid	1
2	13	ST02-0324	Mayo Scissors, Straight, 17 cm / 6¾"	1
3	71	ST02-3720	Covault Hooks, 16 cm / 6¼"	1
4	35	ST02-1961	Kelly Artery Forceps, Curved, 14 cm / 5½"	2
5	14	ST02-0420	Metzenbaum Dissecting Scissors, Curved, 18 cm / 7"	1
6	31	ST02-1690	Gillies Dissecting Forceps, 1 x 2 Teeth, 14 cm / 5½"	1
7	44	ST02-2380	Allis Tissue Forceps, 4 x 5 Teeth, 15 cm / 6"	1
8	49	ST02-2600	Backhaus Towel Clamps, 9 cm / 3½"	4
9	30	ST02-1610	Adson-Brown Forceps, 7 x 7 Teeth, 12 cm / 4¾"	1
10	95	ST02-5062	Olsen-Hegar needle holder TC, 17 cm / 6¾"	1
11	34	ST02-1907	Halsted-Mosquito Artery Forceps, 12.5 cm / 5", curved	2
12	39	ST02-2193	Rochester-Carmalt Artery Forceps, Curved, 16 cm / 6¼"	2
13	378		Instrument Case : Make your choice from page no 378	1



**ST10-0012 Bitch Spay Kit**

S. No.	Page No.	Item No.	Description	Quantity
1	27	ST02-1364	Tissue Forceps, 1 x 2 Teeth, 13 cm / 5"	1
2	95	ST02-5060	Olsen-Hegar Needle Holder TC, 14 cm / 5½"	1
3	37	ST02-2052	Spencer-wells Artery forceps, 15 cm / 6", Straight	2
4	37	ST02-2053	Spencer-wells Artery forceps, 15 cm / 6", Curved	2
5	38	ST02-2094	Rochester-Pean Artery forceps, 18 cm / 7", Straight	2
6	44	ST02-2380	Allis Tissue & Holding forceps, 15 cm / 6", 4 x 5 Teeth	2
7	13	ST02-0324	Mayo Scissors, 17 cm / 6¾", Straight	1
8	49	ST02-2601	Backhaus Towel forceps, 11 cm / 4¼"	4
9	7	ST02-0001	Scalpel Handle No.3 Solid Standard	1
10	70	ST02-3631	Spay Hook, 17 cm / 6¾"	1
11	378		Instrument Case : Make your choice from page no 378	1

**ST10-0013 Bitch Spay Kit**

S. No.	Page No.	Item No.	Description	Quantity
1	37	ST02-2050	Spencer-Wells Artery Forceps, 12.5 cm / 5" Straight	1
2	37	ST02-2051	Spencer-Wells Artery Forceps, 12.5 cm / 5", Curved	1
3	37	ST02-2053	spencer-Wells Artery Forceps, 15 cm / 6", Curved	1
4	39	ST02-2193	Rochester-Carmalt Artery Forceps, 16 cm / 6¼", Curved	1
5	39	ST02-2195	Rochester-Carmalt Artery Forceps, 20 cm / 8", Curved	1
6	13	ST02-0320	Mayo Scissors , 14 cm / 5¾", Straight	1
7	13	ST02-0321	Mayo Scissors , 14 cm / 5¾", Curved	1
8	44	ST02-2361	Allis-Baby Tissue forceps, 3 x 4 Teeth, 15 cm / 6"	2
9	95	ST02-5060	Olsen-Hegar Needle Holders ,TC, 14 cm / 5½"	1
10	27	ST02-1368	Tissue Forceps, 1 x 2 Teeth, 16 cm / 6¼"	1
11	49	ST02-2571	Jones Towel Forceps, 9 cm / 3½"	4
12	7	ST02-0010	Standard Scalpel Handle with Scale No. 3	1

**ST10-0014 Small Animal Surgery Kit**

S. No.	Page No.	Item No.	Description	Quantity
1	17	ST02-0590	Iris fine Operating Scissors, straight, Flat, 11.5 cm / 4½"	1
2	22	ST02-0920	Mayo scissors TC, 14.5 cm / 5¾", straight	1
3	7	ST02-0001	Standard Scalpel Handle No. 3, Solid	1
4	8	ST02-0070	Standard Scalpel Handle No. 4, Solid	1
5	93	ST02-4971	Mayo-Hager Needle Holder TC, 16 cm / 6¼"	1
6	34	ST02-1906	Halsted-Mosquito Artery forceps, Straight, 12.5 cm / 5"	2
7	34	ST02-1907	Halsted-Mosquito Artery forceps, Curved, 12.5 cm / 5"	2
8	35	ST02-1960	Kelly Artery Forceps, Straight, 14 cm / 5½"	2
9	35	ST02-1961	Kelly Artery Forceps, Curved, 14 cm / 5½"	2
10	27	ST02-1328	Standard Dissecting Forceps, 16 cm / 6¼"	1
11	27	ST02-1368	Tissue Dissecting Forceps, 1 x 2 Teeth, 16 cm / 6¼"	1
12	49	ST02-2601	Backhaus Towel Forceps, 11 cm / 4¼"	4
14	32	ST02-1740	Adson Dissectin Forceps, 12 cm / 4¾"	1
15	32	ST02-1741	Adson Dissectin Forceps, 1 x 2 Teeth, 12 cm / 4¾"	1
16	30	ST02-1610	Adson-Brown Forceps, 7 x 7 Teeth, 12 cm / 4¾"	1

**ST10-0015 Canine Spay Kit**

S. No.	Page No.	Item No.	Description	Quantity
1	40	ST02-2233	Fergusson Dissecting & Ligature Forceps, Curved , 20 cm / 8"	2
2	13	ST02-0320	Mayo Scissors, 14 cm / 5½", Straight	1

S. No.	Page No.	Item No.	Description	Quantity
3	27	ST02-1302	Treves Tissue Forceps, 15 cm / 6", 1 x 2 Teeth	1
4	37	ST02-2053	Spencer-Wells, 15 cm / 6", Curved	4
5	44	ST02-2380	Allis Tissue Forceps, 15 cm / 6", 4 x 5 Teeth	2
6	359	ST07-0005	Fenestrated drape	1
7	90	ST02-4792	Olsen-Hegars Needle Holder, 17 cm / 6¾"	1
8	49	ST02-2570	Jones Towel Forceps, 5 cm / 2"	4
9	7	ST02-0001	Standard Scalpel Handle No.3, Solid	1
10	378		Instrument Case : Make your choice from page no 378	1

### Spay Pack Canine (Bitch Spay Kit) ST10-0016

S. No.	Page No.	Item No.	Description	Quantity
1	13	ST02-0324	Mayo Scissors 17 cm / 6¾", Straight	1
2	7	ST02-0001	Standard Scalpel/blade Handel No. 3, Solid	1
3	71	ST02-3720	Covault Hook, 16 cm / 6¼"	1
4	35	ST02-1961	Kelly Artery Forceps, 14 cm / 5½", Curved	2
5	14	ST02-0401	Metzenbaum Dissecting Scissors, 14.5 cm / 5½", Curved	1
6	27	ST02-1326	Standard Tissue Forceps, 14.5 cm / 5½"	1
7	31	ST02-1690	Gillies Dissecting Forceps, 14 cm / 5½"	1
8	44	ST02-2380	Allis Tissue Forceps, 15 cm / 6", 4 x 5 Teeth	1
9	49	ST02-2600	Backhaus Towel Clamps, 9 cm / 3½"	4
10	30	ST02-1610	Adson-brown Forceps 12 cm / 4¾", 7 x 7 Teeth	1
11	90	ST02-4792	Olsen-Hegar Needle Holder, 17 cm / 3¾"	1
12	34	ST02-1907	Halstead Mosquito Artery Forceps, 12.5 cm / 5", Curved	2
13	39	ST02-2193	Rochester-Carmalt Artery Forceps, 16 cm / 6¼", Curved	2

### General Surgery Kit ST10-0017

S. No.	Page No.	Item No.	Description	Quantity
1	13	ST02-0324	Mayo Scissors, 17 cm / 6¾", Straight	1
2	7	ST02-0001	Standard scalpel/blade Handel, No. 3, Solid	1
3	71	ST02-3720	Covault Hook, 16 cm / 6¼"	1
4	34	ST02-1907	Halsted-Mosquito Artery Forceps, Curved, 12.5 cm / 5"	3
5	35	ST02-1960	Kelly Artery Forceps, Straight, 14 cm / 5½"	2
6	14	ST02-0420	Metzenbaum Dissecting Scissors, 18 cm / 7", Curved	1
7	30	ST02-1610	Adson-Brown Forceps, 12 cm / 4¾", 7 x 7 Teeth	1
8	39	ST02-2193	Rochester- Carmalt Artery Forceps, 16 cm / 6¼", Curved	4
9	49	ST02-2602	Backhaus Towel Clamps, 13 cm / 5¼"	4
10	95	ST02-5060	Olsen-Hegar Needle Holder, TC, 14 cm / 5½"	1
11	378		Instrument Case : Make your choice from page no 378	1

### General Surgery Kit ST10-0018

S. No.	Page No.	Item No.	Description	Quantity
1	71	ST02-3720	Covault Hook, 16 cm / 6¼"	1
2	95	ST02-5060	Olsen-Hegar Needle Holder, TC, 14 cm / 5½"	1
3	22	ST02-0922	Mayo Scissors, 17 cm / 6¾", TC, Straight	1
4	24	ST02-1022	Metzenbaum Scissors, 18 cm / 7", Curved	1
5	30	ST02-1610	Adson-Brown Forceps, 12 cm / 4¾", 7 x 7 Teeth	1
6	7	ST02-0001	Standard Scalpel/blade Handel No. 3, Solid	1
7	49	ST02-2602	Backhaus Towel Clamps, 13 cm / 5¼"	1
8	34	ST02-1907	Halsted-Mosquito Artery Forceps, Curved, 12.5 cm / 5"	1

S. No.	Page No.	Item No.	Description	Quantity
9	35	ST02-1960	Kelly Artery Forceps, Straight, 14 cm / 5½"	1
10	39	ST02-2193	Rochester-Carmalt Artery Forceps, 16 cm / 6¼", Curved	1

### ST10-0019 Small Animal Surgery Kit

S. No.	Page No.	Item No.	Description	Quantity
1	17	ST02-0590	Iris Fine Operating Scissors, 11.5 cm / 4½"	1
2	22	ST02-0920	Mayo Scissors, 14.5 cm / 5¾", Straight	1
3	7	ST02-0001	Standard Scalpel Handle No.3, Solid	1
4	8	ST02-0070	Scalpel Handle No.4, Solid	1
5	93	ST02-4971	Mayo-Hager Needle Holder TC, 16 cm / 6¼"	1
6	34	ST02-1907	Halsted-Mosquito Artery Forceps, Curved, 12.5 cm / 5"	2
7	34	ST02-1906	Halsted-Mosquito Artery Forceps, Straight, 12.5 cm / 5"	2
8	35	ST02-1960	Kelly Artery Forceps, 14 cm / 5½", Straight	2
9	35	ST02-1961	Kelly Artery Forceps, 14 cm / 5½", Curved	2
10	27	ST02-1328	Standard Dressing Forceps, 16cm / 6¼"	1
11	27	ST02-1368	Standard Dressing Forceps, 1 x 2 Teeth, 16 cm / 6¼"	1
12	49	ST02-2601	Backhaus Towel Forceps, 11 cm / 4¼"	4
13	32	ST02-1740	Adson Dissecting Forceps, 12 cm / 4¾"	1
14	32	ST02-1741	Adson Dissecting Forceps, 1 x 2 Teeth, 12 cm / 4¾"	1
15	30	ST02-1610	Adson Brown Micro Forceps , 7 x 7 Teeth, 12 cm / 4¾"	1

### ST10-0020 General Surgery Set

S. No.	Page No.	Item No.	Description	Quantity
1	89	ST02-4741	Mayo-Hegar Needle Holder, 16 cm / 6¼"	1
2	49	ST02-2571	Jones Towel Forceps, 9 cm / 3½"	4
3	48	ST02-2554	Foerster Splinter Forceps, 25 cm / 10", Straight	1
4	35	ST02-1981	Crile Artery Forceps, 14 cm / 5½", Curved	4
5	35	ST02-1980	Crile Artery Forceps, 14 cm / 5½", Straight	4
6	27	ST02-1366	Tissue Dressing Forceps, 14.5 cm / 5½", 1 x 2 Teeth	2
7	27	ST02-1326	Standard Dressing Forceps, 14.5 cm / 5½", Straight	2
8	11	ST02-0226	Standard Operating Scissors, 14.5 cm / 5½", Sharp/Blunt	1
9	17	ST02-0590	Iris-Fine Operating Scissors, 11.5 cm / 4½", Straight, Flat	1
10	17	ST02-0593	Iris-Fine Operating Scissors, 11.5 cm / 4½", Curved, Flat	1
11	13	ST02-0320	Mayo Scissors, 14 cm / 5¾", Blunt/Blunt, Straight	1
12	45	ST02-2420	Babcock Tissue Forceps, 16 cm / 6¼", Straight	1
13	44	ST02-2380	Allis Tissue & Holding Forceps, 15 cm / 6", 4 x 5 Teeth	1
14	6	ST01-0360	Frazier Suction Tube, 19 cm / 7½", 2 mm, Fr 06	1
15	74A	ST02-3870	Deaver Retractor, 18 cm / 7", Width 19 mm	2
16	68	ST02-3550	Langenbeck-Green Hooklet, 16 cm / 6¼", Blade 16 x 6 mm	2
17	34	ST02-1904	Halsted-Mosquito Artery Forceps, 12 cm / 4¾", Straight	4
18	189	ST03-5255	Gillies Hook, 18 cm / 7", Fig. 1, Sharp	2
19	7	ST02-0001	Standard Scalpel Handle, No.3, Solid	1
20	8	ST02-0070	Standard Scalpel Handle, No.4, Solid	1
21	378		Instrument Case : Make your choice from page no 378	1

### ST10-0021 Dissecting Kit - 1

S. No.	Page No.	Item No.	Description	Quantity
1	7	ST02-0001	Standard Scalpel Handle No.3, Solid	1
2	50	ST02-2631	Ball-Socket Tubing Clamps, 14 cm / 5½"	4
3	35	ST02-1981	Crile Artery Forceps, 14 cm / 5½", Curved	1

S. No.	Page No.	Item No.	Description	Quantity
4	27	ST02-1300	Treves Tissue Forceps, 1 x 2 Teeth, 12.5 cm / 5", Curved	1
5	27	ST02-1324	Standard Dressing Forceps, 13 cm / 5"	1
6	32	ST02-1741	Adson Dissecting Forceps, 1 x 2 Teeth, 15 cm / 6"	1
7	13	ST02-0325	Mayo Scissors, 17 cm / 6¾", Curved	1
8	90	ST02-4790	Olsen-Hegar Needle Holder, 14 cm / 5½"	1
9	14	ST02-0390	Metzenbaum Dissecting Scissors, 15 cm / 6", Straight	1
10	378		Instrument Case : Make your choice from page no 378	1

### Dissecting Kit - 2 ST10-0022

S. No.	Page No.	Item No.	Description	Quantity
1	7	ST02-0001	Standard Scalpel Handle No.3, Solid	1
2	90	ST02-4790	Olsen-Hegar Needle Holder, 14 cm / 5½"	1
3	14	ST02-0390	Metzenbaum Scissors, 15 cm / 6", Straight	1
4	49	ST02-2601	Backhaus Towel Forceps, 11 cm / 4¼"	4
5	35	ST02-1981	Crile Artery Forceps, 14 cm / 5½", Curved	1
6	27	ST02-1300	Treves Tissue Forceps, 12.5 cm / 5", 1 x 2 Teeth, Curved	1
7	27	ST02-1324	Standard Dressing Forceps, 13 cm / 5"	1
8	32	ST02-1741	Adson Tissue Forceps, 12 cm / 4¾", 1 x 2 Teeth	1
9	13	ST02-0325	Mayo Scissors, 17 cm / 6¾", Curved	1
10	8	ST02-0070	Standard Scalpel Handle No.4, Solid	1
11	11	ST02-0224	Standard Operating Scissors, 13 cm / 5", Sharp/Blunt, Straight	1
12	378		Instrument Case : Make your choice from page no 378	1

### Dissecting Kit - 3 ST10-0023

S. No.	Page No.	Item No.	Description	Quantity
1	37	ST02-2053	Spencer-Wells Artery Forceps, 15 cm / 6", Curved	2
2	37	ST02-2052	Spencer-Wells Artery Forceps, 15 cm / 6", Straight	2
3	7	ST02-0001	Standard Scalpel Handle No.3, Solid	1
4	29	ST02-1554	Lane Dressing Forceps, 15 cm / 6", 1 x 2 Teeth	1
5	13	ST02-0320	Mayo Operating Scissor, 14 cm / 5¾", Straight	1
6	90	ST02-4760	Gillies Needle Holder, 16 cm / 6¼", Right Hand	1
7	378		Instrument Case : Make your choice from page no 378	1

### Stitch Up Kit - 1 ST10-0024

S. No.	Page No.	Item No.	Description	Quantity
1	37	ST02-2053	Spencer-Wells Artery Forceps, 15 cm / 6", Curved	2
2	37	ST02-2052	Spencer-Wells Artery Forceps, 15 cm / 6", Straight	2
3	7	ST02-0001	Standard Scalpel Handle No.3, Solid	1
4	29	ST02-1554	Lanes Dressing Forceps, 15 cm / 6", 1 x 2 Teeth	1
5	13	ST02-0320	Mayo Operating Scissors, 14 cm / 5¾", Straight	1
6	90	ST02-4792	Olesen-Hegar Needle holder, 17 cm / 6¾"	1
7	378		Instrument Case : Make your choice from page no 378	1

### Stitch Up Kit - 2 ST10-0025

S. No.	Page No.	Item No.	Description	Quantity
1	37	ST02-2053	Spencer-Wells Artery Forceps, 15 cm / 6", Curved	2
2	37	ST02-2052	Spencer-Wells Artery Forceps, 15 cm / 6", Straight	2
3	7	ST02-0001	Standard Scalpel Handle No.3, Solid	1
4	29	ST02-1554	Lanes Dressing Forceps, 15 cm / 6", 1 x 2 Teeth	1
5	13	ST02-0320	Mayo Operating Scissors, 14 cm / 5¾", Straight	1

S. No.	Page No.	Item No.	Description	Quantity
6	93	ST02-4971	Mayo-Hegar Needle Holder, 16 cm / 6¼", TC	1
7	378		Instrument Case : Make your choice from page no 378	1

**ST10-0026 Stitch Up Kit - 3**

S. No.	Page No.	Item No.	Description	Quantity
1	37	ST02-2053	Spencer-Wells Artery Forceps, 15 cm / 6", Curved	2
2	37	ST02-2052	Spencer-Wells Artery Forceps, 15 cm / 6", Straight	2
3	7	ST02-0001	Standard Scalpel Handle No.3, Solid	1
4	29	ST02-1554	Lane Dressing Forceps, 15 cm / 6", 1 x 2 Teeth	1
5	13	ST02-0320	Mayo Operating Scissors, 14 cm / 5¾", Straight	1
6	95	ST02-5061	Olsen-Hegar, Needle Holder, 16 cm / 6¼", TC	1
7	378		Instrument Case : Make your choice from page no 378	1

**ST10-0027 Exotic Animal Surgical Kit**

S. No.	Page No.	Item No.	Description	Quantity
1	11	ST02-0228	Standard Operating Scissors, 15.5 cm / 6", Straight	1
2	76	ST02-3940	Alm Retractor, Self-retaining, 7 cm / 2¾", Sharp	1
3	27	ST02-1324	Forceps, Dressing 13 cm / 5", Straight	1
4	26	ST02-1230	Iris Scissors, 11.5 cm / 4½", Straight, TC	1
5	90	ST02-4791	Olsen-Hegar Needle Holder, 16 cm / 6¼"	1
6	7	ST02-0001	Standard Scalpel Handle No.3, Solid	1
7	30	ST02-1590	Adson Micro Forceps, 12 cm / 4¾"	1
8	34	ST02-1901	Mosquito Forceps, 9 cm / 3½", Curved	2
9	34	ST02-1900	Halsted-Mosquito Artery Forceps, 9 cm / 3½"	2
10	378		Instrument Case : Make Your Choice From Page No 378	1

**ST10-0028 Student Veterinary Kit**

S. No.	Page No.	Item No.	Description	Quantity
1	14	ST02-0380	Metzenbaum Dissecting Scissors, 11.5 cm / 4½", Straight	1
2	14	ST02-0381	Metzenbaum Dissecting Scissors, 11.5 cm / 4½", Curved	1
3	27	ST02-1326	Standard Dressing Forceps, 14.5 cm / 5½"	1
4	92	ST02-4940	Nevert Needle Holder, 13 cm / 5", TC	1
5	8	ST02-0070	Standard Scalpel Handle # 4, Solid	1
6	66	ST02-3495	Teasing needle, Straight	1
7	66	ST02-3496	Teasing needle, Angled	1
8	378		Instrument Case : Make your choice from page no 378	1

**ST10-0029 Lab Animal Kit**

S. No.	Page No.	Item No.	Description	Quantity
1	14	ST02-0410	Metzenbaum Scissors, Straight, 18 cm / 7"	1
2	14	ST02-0401	Metzenbaum Scissors, Curved, 14.5 cm / 5½", Blunt / Blunt	1
3	27	ST02-1364	Tissue Forceps, 13 cm / 5", 1 x 2 Teeth	1
4	27	ST02-1324	Standard Dressing Forceps, 13 cm / 5"	1
5	28	ST02-1496	Nugent Utility Forceps, 45° Angled Jaws, 11 cm / 4¼"	1
6	149	ST03-3000	Blumenthal Bone Rongeur, 15 cm / 6", Slightly Curved	1
7	378		Instrument Case : Make your choice from page no 378	1

**Student Anatomy Kit ST10-0030**

S. No.	Page No.	Item No.	Description	Quantity
1	02	ST01-0070	Steel Ruller, 20 cm / 8"	1
2	87	ST02-4595	Mall probe	1
3	66	ST02-3495	Teasing Needle, Straight	1
4	66	ST02-3496	Teasing Needle, Angled	1
5	27	ST02-1328	Standard Dressing Forceps, 16 cm / 6¼"	1
6	34	ST02-1906	Halsted-Mosquito Artery forceps, 12.5 cm / 5", Straight	1
7	7	ST02-0001	Standard Scalpel Handle No.3, Solid	1
8	8	ST02-0070	Standard Scalpel Handle No. 4, Solid	1
11	12	ST02-0284	Standard Dressing Scissors, 14.5 cm / 5½", sharp / blunt	1
12	334	ST06-0980	Witte hook with chain, 31 cm / 12¼"	1
13	378		Instrument Case : Make your choice from page no 378	1

**Veterinary Paw Kit ST10-0031**

S. No.	Page No.	Item No.	Description	Quantity
1	89	ST02-4741	Mayo-Hager Needle Holder, 16 cm / 6¼"	1
2	92	ST02-4940	Neivert Needle Holder TC, 13 cm / 5"	1
3	32	ST02-1740	Adson Dissecting Forceps, 12 cm / 4¾"	1
4	34	ST02-1906	Halsted-Mosquito Artery Forceps, 12.5 cm / 5", Straight	1
5	34	ST02-1907	Halsted-Mosquito Artery Forceps, 12.5 cm / 5", Curved	1
6	33	ST02-1890	Splinter Forceps With Magnifying Glass, 12 cm / 4¾"	1

**Birds Dissection Kit ST10-0032**

S. No.	Page No.	Item No.	Description	Quantity
1	66	ST02-3495	Teasing Needle, Straight	1
2	66	ST02-3496	Teasing Needle, Angled	1
3	17	ST02-0590	Iris Fine Operating Scissors, 11.5 cm / 4½"	1
4	27	ST02-1328	Standard Dressing Forceps, 16 cm / 6¼"	1
5	7	ST02-0001	Standard Scalpel Handle No. 3, Solid	1
6	32	ST02-1740	Adson Dissecting Forceps, 12 cm / 4¾"	1
7	32	ST02-1741	Adson Dissecting Forceps, 12 cm / 4¾", 1 x 2 Teeth	1
8	181	ST03-4760	Iris Forceps, 10.5 cm / 4½", Straight, 1 x 2 Teeth	1
9	33	ST02-1890	Splinter Forceps With Magnifying Glass, 12 cm / 4¾"	1
10	34	ST02-1906	Halsted-Mosquito Forceps, 12.5 cm / 5"	1
11	02	ST01-0070	Stainless Steel Scale, 20 cm / 8"	1
12	378		Instrument Case : Make Your Choice From Page No 378	1

**Birds Dissection Kit ST10-0033**

S. No.	Page No.	Item No.	Description	Quantity
1	78	ST02-3970	Weitlaner Retractor, 10.5 cm / 4¼", 2 x 3 Teeth, Sharp	1
2	78	ST02-3982	Weitlaner Retractor, 14 cm / 5½", 3 x 4 Teeth, Sharp	1
3	62	ST02-3272	Mayo-Hegar, 16 cm / 6¼", TC, For Left Hand	1
4	32	ST02-1741	Adson Dissecting Forceps, 12 cm / 4¾", 1 x 2 Teeth	1
5	32	ST02-1740	Adson Dissecting Forceps, 12 cm / 4¾"	1
6	35	ST02-1960	Kelly Artery Forceps 14 cm / 5½", Straight	1
7	35	ST02-1961	Kelly Artery Forceps 14 cm / 5½", Curved	1
8	69	ST02-3600	Senn-Miller Retractors, 16 cm / 6¼", 7 x 8.5 mm, 3 Prongs	1
9	124	ST03-1703	Lempert Bone Curette, 17.5 cm / 6½"	1
10	95	ST02-5061	Olsen-Hager Needle Holder, TC, 16 cm / 6¼"	1
11	13	ST02-0326	Mayo Scissors, 23 cm / 9", Straight	1
12	14	ST02-0420	Metzenbaum Dissecting Scissors, 18 cm / 7", Curved	1
13	7	ST02-0001	Standard Scalpel Handle, No. 3, Solid	1

**ST10-0034 Postmortem Kit**

S. No.	Page No.	Item No.	Description	Quantity
1	13	ST02-0326	Mayo Scissors, 23 cm / 9", Straight	1
2	20	ST02-0740	Bowel Operating Gum & Ligature Scissors, 21 cm / 8½"	1
3	22	ST02-0922	Mayo Scissors TC, 17 cm / 6¾", Straight	1
4	12	ST02-0288	Standard Dissection Scissors, 16.5 cm / 6½", Sharp / Blunt	1
5	10	ST02-0195	Boning Knife, Sharp, 9.5 cm / 3¾"	1
6	106	ST03-0410	Satterlee Bone Saw, 30 cm / 12", Blade 23 cm / 9"	1
7	101	ST03-0140	Cottle Mallet, 19 cm / 7½", 240 gm	1
8	261	ST04-5130	Sharpening Stone	1
9	8	ST02-0070	Standard Scalpel Handle No. 4, Solid	1
10	7	ST02-0001	Standard Scalpel Handle No. 3, Solid	1
11	03	ST01-0115	Measuring Tape, 2 mm	1
12	09	ST02-0150	Spine Wrench, 22.5 cm / 8¾"	1
13	10	ST02-0196	Brain Knife	1
14	27	ST02-1328	Standard Dressing Forceps, 16 cm / 6¼"	1
15	153	ST03-3190	Liston Bone Cutting Forceps, 14 cm / 5½"	1
16	126	ST03-1861	Bone Chisel, 13.5 cm / 5¼", 6 mm	1
17	35	ST02-1960	Kelly Artery Forceps, 14 cm / 5½", Straight	1
18	35	ST02-1961	Kelly Artery Forceps, 14 cm / 5½", Curved	1
19	27	ST02-1368	Tissue Dressing Forceps, 16 cm / 6¼", 1 x 2 Teeth	1
20	378		Instrument Case : Make Your Choice From Page No 378	1

**ST10-0035 Dog Ear Suture Kit**

S. No.	Page No.	Item No.	Description	Quantity
1	89	ST02-4740	Mayo-Hager Needle Holder, 14 cm / 5½"	1
2	32	ST02-1740	Adson Dissecting Forceps, 12 cm / 4¼"	1
3	19	ST02-0670	Spencer Fine Operating Scissors, 9 cm / 3½", Normal	1
4	35	ST02-1960	Kelly Artery Forceps, 14 cm / 5½", Straight	1
5	11	ST02-0226	Standard Operating Scissors, 14.5 cm / 5½", Sharp/Blunt	1
6	7	ST02-0001	Standard Scalpel Handle No.3, Solid	1

**ST10-0036 Rat Dissection Kit**

S. No.	Page No.	Item No.	Description	Quantity
1	185	ST03-5030	Vannas Cataract Scissors, 8.5 cm / 3½", Curved	1
2	26	ST02-1234	Iris Scissors, 11.5 cm / 4½", TC, Straight	1
3	89	ST02-4741	Mayo-Hager Needle Holder, 16 cm / 6¼"	1
4	87	ST02-4613	Abdominal Retractors, 12.5 cm / 5"	1
5	181	ST03-4760	Iris Forceps, 10.5 cm / 4½", 1x 2 Teeth, Straight	1
6	30	ST02-1590	Adson Micro Forceps, 12 cm / 4¾"	1
7	76	ST02-3940	Alm Retractor, 7 cm / 2¾", Sharp	1

**ST10-0037 Dog Ear Cropping Guide Set**

S. No.	Page No.	Item No.	Description	Quantity
1	342	ST06-1591	Dogs Ear docking Straight, 15 cm / 6"	1
2	342	ST06-1590	Pitbull Ear Cropping Guide, 12 cm / 4¾"	1
3	342	ST06-1601	Schnauzer Ear Cropping Guide, 15 cm / 6"	1
4	342	ST06-1600	Dogs Ear docking, Straight, 12 cm / 4¾"	1
5	12	ST02-0266	Standard Operating Scissors, 15.5 cm / 6", Blunt/blunt, Curved	1
6	191	ST03-5421	Aural Crocodile Forceps, 13 cm / 5" Shaft, Standard Jaw	1
7	7	ST02-0001	Standard Scalpel Handle No.3, Solid	1

**Pets First Aid Instrument Kit ST10-0038**

S. No.	Page No.	Item No.	Description	Quantity
1	35	ST02-1961	Kelly Artery Forceps, 14 cm / 5½" Curved	1
2	11	ST02-0226	Standard Operating Scissors, 14.5 cm / 5½" Sharp/Blunt	1
3	27	ST02-1328	Standard Dressing Forceps, 16 cm / 6¼"	1
4	21	ST02-0760	Bandage Scissors, 14.5 cm / 5¾", Black	1
5	351	ST06-2190	Nail Nippers, 14 cm / 5½"	1
6	378		Instrument Case : Make Your Choice From Page No 378	1

**Micro Surgical Instrument Kit ST10-0039**

S. No.	Page No.	Item No.	Description	Quantity
1	88	ST02-4650	Derf Needle Holder, 12 cm / 4¾"	1
2	185	ST03-5040	Castroviejo Iridectomy, Micro Scissors, Straight, 10 cm / 4"	1
3	29	ST02-1540	Swiss Jeweler Style Forceps, Style 5, Micro-fine, 11 cm / 4¾"	1
4	181	ST03-4730	St Martin Corneal Forceps, 9 cm / 3½", 1 x 2 Teeth	1
5	185	ST03-5020	Castroviejo Corneal Scissors, 11.5 cm / 4½", Straight	1
6	179	ST03-4570	Barraquer Ophthalmology, Eye Dressing Forceps	1
7	223	ST04-1950	Mirror Handle Double Ended	1
8	378		Instrument Case : Make Your Choice From Page No 378	1

**Basic Veterinary Eye Kit ST10-0040**

S. No.	Page No.	Item No.	Description	Quantity
1	7	ST02-0001	Standard Scalpel Handle No. 3, Solid	1
2	179	ST03-4570	Barraquer Ophthalmology, Eye Dressing Forceps	1
3	181	ST03-4760	Iris Forceps, 10.5 cm / 4½", 1 x 2 Teeth, Straight	1
4	17	ST02-0600	Stevens Tenotomy Scissors, Straight, 11 cm / 4½"	1
5	184	ST03-4950	Chalazion Forceps, Small	1
6	186	ST03-5120	Castroviejo Needle Holder With Lock, Straight, 14 cm / 5½"	1
7	378		Instrument Case : Make Your Choice From Page No 378	1

**Advance Eye Kit ST10-0041**

S. No.	Page No.	Item No.	Description	Quantity
1	7	ST02-0001	Standard Scalpel Handle No. 3, Solid	1
2	182	ST03-4790	Bishop Harmon Forceps, 8.5 cm / 3¼"	1
3	184	ST03-4950	Chalazion Forceps, Small	1
4	17	ST02-0602	Steven Fine Operating Forceps, Straight, 10 cm / 4"	1
5	179	ST03-4570	Barraquer Ophthalmology, Eye Dressing Forceps	1
6	186	ST03-5120	Castroviejo Needle Holder With Lock, Straight, 14 cm / 5½"	1
7	378		Instrument Case : Make Your Choice From Page No 378	1

**Basic Eye Kit ST10-0042**

S. No.	Page No.	Item No.	Description	Quantity
1	7	ST02-0001	Standard Scalpel Handle No. 3, Solid	1
2	182	ST03-4790	Bishop Harmon Forceps, 8.5 cm / 3¼"	1
3	17	ST02-0602	Steven Fine Operating Forceps, Straight, 10 cm / 4"	1
4	179	ST03-4570	Barraquer Ophthalmology, Eye Dressing Forceps	1
5	88	ST02-4650	Derf Needle Holder, 12 cm / 4¾"	1
8	378		Instrument Case : Make your choice from page no 378	1



**ST10-0043 Premium Ophthalmic Kit**

S. No.	Page No.	Item No.	Description	Quantity
1	34	ST02-1903	Halstead-Mosquito Artery Forceps, 10 cm / 4", Curved	1
2	34	ST02-1902	Halstead-Mosquito Artery Forceps, 10 cm / 4", Straight	1
3	180	ST03-4711	Cooks Ophthalmology Eyelid Speculum, Medium	1
4	181	ST03-4740	Castroviejo Corneal Forceps, 9 cm / 3½", 1 x 2 Teeth	1
5	183	ST03-4880	Barraquer Forceps, 7 cm / 2¾"	1
6	184	ST03-4950	Chalazion Forceps, Small	1
7	183	ST03-4910	Graefe Fixation Forceps, 10 cm / 4", 3.5 mm Jaws	1
8	181	ST03-4720	Roberts Tying Forceps, 10 cm / 4"	1
9	181	ST03-4760	Iris Forceps, 10.5 cm / 4½", 1 x 2 Teeth, Straight	1
10	181	ST03-4745	Bennetts Cilia Forceps, 8 cm / 3"	1
11	181	ST03-4775	Arruga Capsule Forceps, 9.5 cm / 3¾"	1
12	190	ST03-5360	Snellens Vectis, 13.5 cm / 5¼"	1
13	190	ST03-5350	Irrigating Vectis Cannula 55 mm	1
14	187	ST03-5150	Castroviejo Needle holder Scissors TC-Supercut, 15 cm / 6"	1
15	17	ST02-0602	Stevens Fine Operating Scissors, Curved, 11 cm / 4½"	1
16	17	ST02-0600	Stevens Fine Operating Scissors, Straight, 11 cm / 4½"	1
17	185	ST03-5020	Castroviejo Corneal Scissors, Straight, 11.5 cm / 4½"	1
18	185	ST03-5021	Castroviejo Corneal Scissors, Curved, 11.5 cm / 4½"	1
19	190	ST03-5390	Beaver Blade Handle 13 cm / 5"	1
20	7	ST02-0001	Standard Scalpel Handle, No. 3, Solid	1
21	49	ST02-2571	Jones Towel Forceps, 9 cm / 3½"	2
22	359	ST07-0005	Fenestrated Reusable Drape	1
23	378		Instrument Case : Make Your Choice From Page No 378	1

**ST10-0044 Ophthalmic Kit**

S. No.	Page No.	Item No.	Description	Quantity
1	34	ST02-1902	Halstead-Mosquito Artery Forceps, 10 cm / 4", Straight	1
2	34	ST02-1903	Halstead-mosquito Artery Forceps, 10 cm / 4", Curved	1
3	190	ST03-5390	Beaver Type Handle (swan Morton 'fine' Series), 13 cm / 5"	1
4	186	ST03-5120	Castroviejo Needle Holder, 14 cm / 5½", Straight	1
5	17	ST02-0602	Stevens Fine Operating Scissors, Curved, 10 cm / 3¾"	1
6	183	ST03-4870	Hess Colibri Iris Forceps, 7 cm / 2¾"	1
7	183	ST03-4910	Graefe Fixation Forceps, 10 cm / 4", 3.5 mm Jaw	1
8	181	ST03-4720	Roberts Tying Forceps, 10 cm / 4"	1
9	185	ST03-5020	Castroviejo Corneal Scissors, 11.5 cm / 4½", Straight	1
10	179	ST03-4570	Barraquer Wire Eyelid Speculum	1

**ST10-0045 Ophthalmic Kit**

S. No.	Page No.	Item No.	Description	Quantity
1	34	ST02-1903	Halstead-Mosquito Artery Forceps, 10 cm / 4", Curved	1
2	34	ST02-1902	Halstead-Mosquito Artery Forceps, 10 cm / 4", Straight	1
3	179	ST03-4570	Barraquer Wire Eyelid Speculum	1
4	181	ST03-4730	St Martin Corneal Forceps, 9 cm / 3½", 1 x 2 Teeth	1
5	183	ST03-4910	Graefe Fixation Forceps, 10 cm / 4", 3.5 mm Jaw	1
6	181	ST03-4760	Iris Forceps, 10.5 cm / 4½", 1 x 2 Teeth, Straight	1
7	181	ST03-4720	Roberts Tying Forceps, 10 cm / 4"	1
8	187	ST03-5140	Castroviejo Needle holders With Scissors TC, 15 cm / 6"	1
9	17	ST02-0602	Stevens Fine Operating Scissors, Curved, 10 cm / 4"	1
10	17	ST02-0600	Stevens Fine Operating Scissors, 11 cm / 4½", Straight	1
11	190	ST03-5390	Beaver Blade Handle, 13 cm / 5"	1
12	49	ST02-2571	Jones Towel Forceps, 9 cm / 3½"	2

S. No.	Page No.	Item No.	Description	Quantity
13	359	ST07-0005	Fenestrated Reusable Drape	1
14	378		Instrument Case : Make Your Choice From Page No 378	1

### Orthopedic Kit ST10-0046

S. No.	Page No.	Item No.	Description	Quantity
1	20	ST02-0720	Universal Scissors, Serrated, 12 cm / 4¾", TC	1
2	69	ST02-3600	Senn-Miller Retractor, Sharp, 16 cm / 6¼", Blade 7 x 8.5 mm	1
3	69	ST02-3601	Senn-Miller Retractor, Blunt, 16 cm / 6¼", Blade 7 x 8.5 mm	1
4	78	ST02-3982	Weitlaner Retractor, Sharp, 3 x 4 Teeth, 14 cm / 5½"	1
5	102	ST03-0180	Periosteal Elevator, Double Ended, 5 mm, Sharp / Blunt	1
6	125	ST03-1783	Spratt Curette, Fig.0, 17 cm / 6¾"	1
7	100	ST03-0065	Lucae Mallet, Solid Stainless, 20 cm / 7¾"	1
8	103	ST03-0230	Fomon Rasp, Double Ended, Coarse, 21 cm / 8¼"	1
9	156	ST03-3330	Wire Twister, Tungsten Carbide, 15 cm / 6"	1
10	106	ST03-0355	Gigli Saw Handle, Handle With Lock	2
11	106	ST03-0370	Gigli Saw, Standard Twisted Wire, 30 cm / 12"	1
12	142	ST03-2704	Kern Bone Holding Forceps with Ratchet, 23 cm / 9"	1
13	142	ST03-2702	Kern Bone Holding Forceps with Ratchet, 17 cm / 6¾"	1
14	162	ST03-3820	Wire Cutting Plier, 22 cm / 8¾"	1
15	153	ST03-3190	Liston Bone Cutting Forceps, 14 cm / 5½"	1
16	128	ST03-2007	Mini-Lambotte Osteotomes, 15 mm Wide, 17 cm / 6¼"	1
17	378		Instrument Case : Make Your Choice From Page No 378	1

### Veterinary Orthopedic Kit ST10-0047

S. No.	Page No.	Item No.	Description	Quantity
1	154	ST03-3251	Ruskin-Liston Bone Cutting Forceps 18.5 cm / 7¼", Angled	1
2	161	ST03-3760	Pin & Wire Cutting Plier Cannulated, 16 cm / 6¼"	1
3	153	ST03-3190	Liston Bone Cutting Forceps, Straight, 14 cm / 5½"	1
4	142	ST03-2703	Kern Bone Holding Forceps with Ratchet, 21 cm / 8¼"	1
5	142	ST03-2700	Kern Bone Holding Forceps with Ratchet, 12 cm / 4¾"	1
6	156	ST03-3330	Wire Twisting Forceps TC, 15 cm / 6"	1
7	103	ST03-0230	Fomon Rasp, Double Ended, Coarse, 21 cm / 8¼"	1
8	100	ST03-0060	Gerzog Bone Mallet, 18 cm / 7"	1
9	125	ST03-1803	Bruns Bone Curette, 17 cm / 6¾", Fig.0	1
10	69	ST02-3600	Senn-Miller Retractor, Sharp, 16 cm / 6¼", 7 x 8.5 mm	1
11	69	ST02-3601	Senn-Miller Retractor, Blunt, 16 cm / 6¼", 7 x 8.5 mm	1
12	102	ST03-0180	Periosteal Elevator, Double Ended, 5 mm, Sharp / Blunt	1
13	78	ST02-3984	Weitlaner Retractor, 16.5 cm / 6½", Sharp, 3 x 4 Teeth	1
14	20	ST02-0720	Universal Wire Cutting Scissors, 12 cm / 4¾", Serrated	1
15	106	ST03-0350	Gigli Saw Handle, T-style	1

### Orthopedic Kit ST10-0048

S. No.	Page No.	Item No.	Description	Quantity
1	20	ST02-0720	Universal Wire Cutting Scissors, 12 cm / 4¾", Serrated	1
2	69	ST02-3600	Senn-Miller Retractor, Sharp, 16 cm / 6¼", Blade 7 x 8.5 mm	1
3	69	ST02-3601	Senn-Miller Retractor, Blunt, 16 cm / 6¼", Blade 7 x 8.5 mm	1
4	78	ST02-3982	Weitlaner Retractor, Sharp, 14 cm / 5½", 3 x 4 Teeth	1
5	102	ST03-0180	Periosteal Freer Elevator, 18 cm / 7", Double Ended	1
6	125	ST03-1783	Spratt Bone Curette, Fig.0, 17 cm / 6¾"	1
7	100	ST03-0065	Lucae Mallet, Solid Stainless, 20 cm / 8", 140 gm / 5 oz	1

S. No.	Page No.	Item No.	Description	Quantity
8	103	ST03-0230	Fomon Rasp, Double Ended, Coarse, 21 cm / 8¼"	1
9	156	ST03-3330	Wire Twister, TC, 15 cm / 6"	1
10	106	ST03-0355	Gigli-Strully Saw Handle, Standard Pattern, T-Shaped	2
11	106	ST03-0370	Gigli Saw, Standard Twisted Wire, 30 cm / 12"	1
12	142	ST03-2704	Kern Bone Holding Forceps with Ratchet, 23 cm / 9"	1
13	142	ST03-2702	Kern Bone Holding Forceps with Ratchet, 17 cm / 6¾"	1
14	162	ST03-3820	Cannulated Pin and Wire Cutter, 22 cm / 8¾"	1
15	153	ST03-3190	Liston Bone Cutting Forceps, Straight, 14 cm / 5½"	1
16	128	ST03-2007	Mini-Lambotte Swiss Pattern Osteotome, 15 mm Wide	1
17	378		Instrument Case : Make your choice from page no 378	1

### ST10-0049 Osteotome Kit

S. No.	Page No.	Item No.	Description	Quantity
1	128	ST03-2000	Lambotte Swiss Pattern Osteotomes, 2 mm, 17 cm / 6¾"	1
2	128	ST03-2002	Lambotte Swiss Pattern Osteotomes, 4 mm, 17 cm / 6¾"	1
3	128	ST03-2003	Lambotte Swiss Pattern Osteotomes, 6 mm, 17 cm / 6¾"	1
4	128	ST03-2004	Lambotte Swiss Pattern Osteotomes, 8 mm, 17 cm / 6¾"	1
5	128	ST03-2005	Lambotte Swiss Pattern Osteotomes, 10 mm, 17 cm / 6¾"	1
6	128	ST03-2006	Lambotte Swiss Pattern Osteotomes, 12 mm, 17 cm / 6¾"	1
7	128	ST03-2007	Lambotte Swiss Pattern Osteotomes, 15 mm, 17 cm / 6¾"	1
8	128	ST03-2008	Lambotte Swiss Pattern Osteotomes, 18 mm, 17 cm / 6¾"	1
9	128	ST03-2041	Lambotte Swiss Pattern Osteotomes, 20 mm, 17 cm / 6¾"	1
10	378		Instrument Case : Make your choice from page no 378	1

### ST10-0050 Osteotome Kit

S. No.	Page No.	Item No.	Description	Quantity
1	128	ST03-2003	Mini-Lambotte Osteotome, 17 cm / 6¾" , Straight, 6 mm	1
2	128	ST03-2006	Mini-Lambotte Osteotome, 17 cm / 6¾" , Straight, 12 mm	1
3	127	ST03-1922	Hoke Osteotome, Straight, 6 mm	1
4	127	ST03-1926	Hoke Osteotome, Straight, 14 mm	1
5	127	ST03-1927	Hoke Osteotome, Straight, 19 mm	1
6	100	ST03-0090	Mead Mallet, Solid, 17 cm / 6¾" , 320 gm, 26 mm Ø	1

### ST10-0051 Bulla Osteotome & Total Ear Canal Ablatoion

S. No.	Page No.	Item No.	Description	Quantity
1	74	ST02-3850	Langenbeck Retractor, 6 mm Blade, 21.5 cm / 6¾"	1
2	74	ST02-3852	Langenbeck Retractor, 13 mm Blade, 21.5 cm / 6¾"	1
3	74	ST02-3853	Langenbeck Retractor, 20 mm Blade, 21.5 cm / 6¾"	1
4	74	ST02-3854	Langenbeck Retractor, 25 mm Blade, 21.5 cm / 6¾"	1
5	74	ST02-3851	Langenbeck Retractor, 6 mm Blade (extra Long)	1
6	79	ST02-4068	Gelpi Self Retaining Retractor, 180 mm, 120 mm Spread	1
7	95	ST02-5073	Olsen Hegars, 17 cm / 6¾" , TC Jaws	1
8	53	ST02-2860	De Bakey Atraumativ Forceps, 16 cm / 6¼"	1
9	149	ST03-2982	Lempert Rongeurs, 19 cm / 7¼" , Long	1
10	125	ST03-1761	Volkman Single Ended Scoop, Fig. 000, 17 cm / 6¾"	1
11	125	ST03-1762	Volkman Single Ended Scoop, Fig. 00, 17 cm / 6¾"	1
12	125	ST03-1763	Volkman Single Ended Scoop, Fig. 0, 17 cm / 6¾"	1

**Extraction Instrument Kit ST10-0052**

S. No.	Page No.	Item No.	Description	Quantity
1	7	ST02-0001	Standard Scalpel Handle No. 3, Solid	1
2	236	ST04-2820	Baby Molt Periosteal Elevator, 15 cm / 6"	1
3	204	ST04-0110	Extracting Forceps Universal Mini, 11.5 cm / 4½"	1
4	18	ST02-0665	La Grange Scissors, Curved, One serrated blade, 11 cm / 4½"	1
5	95	ST02-5060	Olsen-hegar Needle Holder, Tungsten Carbide, 14 cm / 5½"	1
6	30	ST02-1610	Adson-Brown Forceps, 12 cm / 4¾", 7 x 7 Teeth	1
7	11	ST02-0226	Operating Scissors, Straight, Sharp/Blunt, 14 cm / 5½"	1
8	241	ST04-3370	Luxating Elevator, Straight, 2 mm, 11.5 cm / 4½"	1
9	241	ST04-3380	Luxating Elevator, Straight, 3 mm, 11.5 cm / 4½"	1
10	241	ST04-3400	Luxating Elevator, Straight, 5 mm, 11.5 cm / 4½"	1
11	241	ST04-3381	Luxating Elevator, Curved, 3 mm, 11.5 cm / 4½"	1
12	241	ST04-3401	Luxating Elevator, Curved, 5 mm, 11.5 cm / 4½"	1
13	378		Instrument Case : Make Your Choice From Page No 378	

**Canine Dental Kit ST10-0053**

S. No.	Page No.	Item No.	Description	Quantity
1	238	ST04-3060	Winged Elevator, 1 mm	1
2	238	ST04-3070	Winged Elevator, 2 mm	1
3	238	ST04-3080	Winged Elevator, 3 mm	1
4	238	ST04-3090	Winged Elevator, 4 mm	1
5	219A	ST04-1550	Explorer Probe	1
6	236	ST04-2932	Periosteal Elevator, 4 x 4 mm	1
7	205	ST04-0202	Dental Extraction Forceps, Large	1
8	204	ST04-0121	Tartar Forceps, Large	1
9	211	ST04-0580	Subgingival Curette	1

**Feline Dental Kit ST10-0054**

S. No.	Page No.	Item No.	Description	Quantity
1	238	ST04-3060	Winged Elevator, 1 mm	1
2	238	ST04-3070	Winged Elevator, 2 mm	1
3	238	ST04-3080	Winged Elevator, 3 mm	1
4	238	ST04-3090	Winged Elevator, 4 mm	1
5	219A	ST04-1550	Explorer Probe	1
6	236	ST04-2930	Periosteal Elevator, 2 x 2 mm	1
7	204	ST04-0110	Dental Extraction Forceps	1
8	204	ST04-0120	Tartar Forceps, Small	1
9	211	ST04-0580	Subgingival Curette	1

**Veterinary Kit ST10-0055**

S. No.	Page No.	Item No.	Description	Quantity
1	7	ST02-0001	Standard Scalpel Handle No. 3, Solid	1
2	236	ST04-2820	Baby Molt Periosteal Elevator, 2 x 2 mm	1
3	204	ST04-0110	Extracting Forceps, Universal, Mini	1
4	18	ST02-0665	La Grange Scissors, Curved, One serrated blade, 11 cm / 4½"	1
5	95	ST02-5060	Olsen-Hegar Needle Holder, Suture Scissors, 14 cm / 5½"	1
6	30	ST02-1610	Adson-Brown Tissue Forceps, 12 cm / 4¾", 7 x 7 Teeth	1
7	11	ST02-0226	Operating / Suture Scissors, Straight, Sharp/Blunt, 14 cm 5½"	1
8	241	ST00-3370	Luxating Elevator, Straight, 2 mm, 11.5 cm / 4½"	1
9	241	ST04-3380	Luxating Elevator, Straight, 3 mm, 11.5 cm / 4½"	1
10	241	ST04-3400	Luxating Elevator, Straight, 5 mm, 11.5 cm / 4½"	1

S. No.	Page No.	Item No.	Description	Quantity
10	241	ST04-3381	Luxating Elevator, Curved, 3 mm, 11.5 cm / 4½"	1
11	241	ST04-3401	Luxating Elevator, Curved, 5 mm, 11.5 cm / 4½"	1
12	378		Instrument Case : Make Your Choice From Page No 378	1

**ST10-0056 Extraction Kit**

S. No.	Page No.	Item No.	Description	Quantity
1	238	ST04-3060	Winged Elevator With Stubby Handle, 1 mm	1
2	238	ST04-3070	Winged Elevator With Stubby Handle, 2 mm	1
3	238	ST04-3080	Winged Elevator With Stubby Handle, 3 mm	1
4	238	ST04-3090	Winged Elevator With Stubby Handle, 4 mm	1
5	245	ST04-3890	Colored Luxator, Curved, Very fine, 3 mm	1
6	245	ST04-3910	Colored Luxator, Curved, Very fine, 5 mm	1
7	15	ST02-0481	Dean Scissors, Curved, Serrated, 18 cm / 7"	1
8	235	ST04-2760	Molt 2-4 Periosteal Elevator, 2 x 2 mm	1
9	147	ST03-2910	Mini-Friedman Rongeur Forceps, 14 cm / 5½"	1
10	171	ST04-4130	Root Tip Pick, Plate bender, Small, Straight, 19 cm / 7½"	1

**ST10-0057 Extraction Set - Updated (12 Pieces)**

S. No.	Page No.	Item No.	Description	Quantity
1	238	ST04-3060	Winged Elevator With Stubby Handle, 1 mm	1
2	238	ST04-3070	Winged Elevator With Stubby Handle, 2 mm	1
3	238	ST04-3080	Winged Elevator With Stubby Handle, 3 mm	1
4	238	ST04-3090	Winged Elevator With Stubby Handle, 4 mm	1
5	238	ST04-3100	Winged Elevator With Stubby Handle, 5 mm	1
6	238	ST04-3110	Winged Elevator With Stubby Handle, 6 mm	1
7	236	ST04-2932	Periosteal Elevator Double Ended, 4 x 4 mm	1
8	204	ST04-0110	Extraction Forceps Universal	1
9	89	ST02-4740	Mayo-Hegar, Needle Holders, 14 cm / 5½"	1
10	30	ST02-1610	Adson-Brown Tissue Forceps, 12 cm / 4¾", 7 x 7 Teeth	1
11	18	ST02-0665	La Grange Scissors, Curved, One Blade Serrated	1
12	7	ST02-0010	Scalpel Handle, With Scale On One Side	1
13	378		Instrument Case : Make Your Choice From Page No 378	1

**ST10-0058 Extraction Set - Updated (13 Pieces)**

S. No.	Page No.	Item No.	Description	Quantity
1	238	ST04-3060	Winged Elevator With Stubby Handle, 1 mm	1
2	238	ST04-3070	Winged Elevator With Stubby Handle, 2 mm	1
3	238	ST04-3080	Winged Elevator With Stubby Handle, 3 mm	1
4	238	ST04-3090	Winged Elevator With Stubby Handle, 4 mm	1
5	238	ST04-3100	Winged Elevator With Stubby Handle, 5 mm	1
6	238	ST04-3110	Winged Elevator With Stubby Handle, 6 mm	1
7	236	ST04-2930	Periosteal Elevator Double Ended, 4 / 4 mm	1
8	204	ST04-0110	Extraction Forceps Universal	1
9	89	ST02-4740	Mayo-Hegar, Needle Holders, 14 cm / 5½"	1
10	30	ST02-1610	Adson-Brown, Tissue Forceps, 12 cm / 4¼", 7 x 7 Teeth	1
11	18	ST02-0665	La Grange Scissors, Curved, One serrated blade, 11 cm / 4½"	1
12	19	ST02-0691	Spencer Suture Scissors, Curved, 13 cm / 5"	1
13	7	ST02-0010	Scalpel Handle, With Scale On One Side	1
14	378		Instrument Case : Make Your Choice From Page No 378	1

**Feline Instrument Set ST10-0059**

S. No.	Page No.	Item No.	Description	Quantity
1	238	ST04-3060	Elevator, Straight, 1 mm wide Tip	1
2	238	ST04-3070	Elevator, Straight, 2 mm wide Tip	1
3	219B	ST04-1580	Probe / Explorer	1
4	205	ST04-0200	Extraction Forceps	1
5	236	ST04-2880	Periosteal Elevator, Very fine	1
6	217	ST04-1300	Resorptive Lesion Probe	1
7	219	ST04-1480	Sickle Scaler, Double Ended	1
8	211	ST04-0580	Supragingival Curette	1

**Basic Dental Instrument Set ST10-0060**

S. No.	Page No.	Item No.	Description	Quantity
1	224	ST04-1890	Mouth Mirror	1
2	219B	ST04-1580	Probe/explorer	1
3	211	ST04-0520	Canine Tarter Scraper	1
4	214	ST04-0970	Sickle Scaler H6 / H7	1
5	219A	ST04-1555	Gracey Scaler 7/8	1
6	219A	ST04-1560	Barnhart Scaler 5/6	1
7	378		Instrument Case : Make Your Choice From Page No 378	1

**Specialized Instrument Set ST10-0061**

S. No.	Page No.	Item No.	Description	Quantity
1	237	ST04-2990	Molt Periosteal Elevator, Fig. 9	1
2	235	ST04-2760	Deciduous Elevator, Curved, Small, 2 / 2 mm	1
3	235	ST04-2761	Deciduous Elevator, Curved, Medium, 3 / 3 mm	1
4	235	ST04-2762	Deciduous Elevator, Curved, Large, 4 / 4 mm	1
5	204	ST04-0130	Extraction Forceps, Right Angled Jaw	1

**Elevators Set, Standard Handle ST10-0062**

S. No.	Page No.	Item No.	Description	Quantity
1	238	ST04-3120	Winged Elevator, Standard Handle, 1 mm	1
2	238	ST04-3130	Winged Elevator, Standard Handle, 2 mm	1
3	238	ST04-3140	Winged Elevator, Standard Handle, 3 mm	1
4	238	ST04-3150	Winged Elevator, Standard Handle, 4 mm	1
5	238	ST04-3160	Winged Elevator, Standard Handle, 5 mm	1
6	249	ST04-4320	Root Tip Pick, Straight	1
7	204	ST04-0150	Tartar Removing Forceps, Standard	1
8	205	ST04-0202	Extraction Forceps, Large	1
9	261	ST04-5170	Minnesota Retractor	1
10	211	ST04-0580	Supragingival Curette	1
11	212	ST04-0640	Jaquette Supragingival Scaler	1
12	214	ST04-0980	Sickle Scaler, Curved	1
13	219A	ST04-1545	Explorer / Measuring Probe	1
14	102	ST03-0180	Double Ended Periosteal Elevator	1

**Elevators Set, Stubby Handle ST10-0063**

S. No.	Page No.	Item No.	Description	Quantity
1	238	ST04-3060	Winged Elevator, Stubby Handle, 1 mm	1
2	238	ST04-3070	Winged Elevator, Stubby Handle, 2 mm	1
3	238	ST04-3080	Winged Elevator, Stubby Handle, 3 mm	1
4	238	ST04-3090	Winged Elevator, Stubby Handle, 4 mm	1
5	238	ST04-3100	Winged Elevator, Stubby Handle, 5 mm	1

S. No.	Page No.	Item No.	Description	Quantity
6	249	ST04-4320	Root Tip Pick, Straight	1
7	204	ST04-0150	Tartar Removing Forceps	1
8	205	ST04-0202	Extraction Forceps, Large	1
9	261	ST04-5170	Minnesota Retractor	1
10	211	ST04-0580	Supraperingival Curette	1
11	212	ST04-0640	Jaquette Supraperingival Scaler	1
12	214	ST04-0980	Sickle Scaler, Curved	1
13	219A	ST04-1545	Explorer / Measuring Probe	1
14	102	ST03-0180	Double Ended Periosteal Elevator	1

### ST10-0064 Extraction Set

S. No.	Page No.	Item No.	Description	Quantity
1	238	ST04-3060	Winged Elevator, Stubby Handle, 1 mm	1
2	238	ST04-3070	Winged Elevator, Stubby Handle, 2 mm	1
3	238	ST04-3080	Winged Elevator, Stubby Handle, 3 mm	1
4	238	ST04-3090	Winged Elevator, Stubby Handle, 4 mm	1
5	238	ST04-3100	Winged Elevator, Stubby Handle, 5 mm	1
6	238	ST04-3110	Winged Elevator, Stubby Handle, 6 mm	1
7	236	ST04-2870	Periosteal Elevator Double Ended, 2 x 2 mm	1
8	205	ST04-0202	Extraction Forceps, Large	1
9	89	ST02-4740	Mayo-Hegar Needle Holders, 14 cm / 5½"	1
10	30	ST02-1610	Adson-Brown, Tissue Forceps, 12 cm / 4¾", 7 x 7 Teeth	1
11	17	ST02-0590	Iris Scissors, Straight Flat, 11.5 cm / 4½"	1
12	7	ST02-0001	Standard Scalpel Handle, No. 3, Solid	1
13	378		Instrument Case : Make Your Choice From Page No 378	1

### ST10-0065 Feline Instruments Set

S. No.	Page No.	Item No.	Description	Quantity
1	249	ST04-4320	Tip Elevators, Straight	1
2	241	ST04-3360	Luxator, Straight Tip, Stubby Handle, 1 mm, 11.5 cm / 4½"	1
3	241	ST04-3370	Luxator, Straight Tip, Stubby Handle, 2 mm, 11.5 cm / 4½"	1
4	225	ST04-1950	Probe / Explorer, Double Ended	1
5	236	ST04-2870	Periosteal Elevator, Double Ended, Very Fine, 2 / 2 mm	1
6	217	ST04-1300	Resorptive Lesion Probe	1
7	214	ST04-0940	Sickle Scaler, Double Ended	1
8	220	ST04-1690	Curette, Double Ended	1
9	204	ST04-0110	Extraction Forceps, Small	1

### ST10-0066 Dog Dental Extraction Kit

S. No.	Page No.	Item No.	Description	Quantity
1	7	ST02-0001	Standard Scalpel Handle, No. 3, Solid	1
2	95	ST02-5061	Olsen-Hager Needle Holder TC, 16 cm / 6¼"	1
3	23	ST02-0950	Mayo-Stille Scissors TC, 15 cm / 6", Straight	1
4	18	ST02-0665	La Grange Scissors, 11 cm / 4¼"	1
5	236	ST04-2870	Molt Periosteal Elevator, 16 cm / 6¼"	1
6	34	ST02-1907	Halsted-Mosquito Forceps, Curved, 12.5 cm / 5"	1
7	34	ST02-1906	Halsted-Mosquito Forceps, Straight, 12.5 cm / 5"	1
8	31	ST02-1710	College Tweezers, 15 cm / 6"	1

S. No.	Page No.	Item No.	Description	Quantity
9	32	ST02-1741	Adson Tissue Forceps, 12 cm / 4½", 1 x 2 Teeth	1
10	30	ST02-1610	Adson-Brown Tissue Forceps, 12 cm / 4½", 7 x 7 Teeth	1
11	252	ST04-4451	Elevator Straight, 3 mm	1
12	250	ST04-4380	Elevator 2 mm, Angled, 15 cm / 6"	1
13	252	ST04-4453	Elevator, Straight, 5 mm	1
14	250	ST04-4382	Coupland Elevator, 3 mm, Angled, 15 cm / 6"	1
15	208	ST04-0340	Klein Forceps For Upper Incisors & Canines, Fig. 137	1
16	208	ST04-0325	Extraction Forceps For Upper Molar, Fig. 3	1
17	208	ST04-0320	Cryer Extraction Forceps, Fig.150s	1
18	208	ST04-0335	Cryer Extraction Forceps, Fig.151s	1

### Instruments Specially Designed For Feline / Very Small Dogs **ST10-0067**

S. No.	Page No.	Item No.	Description	Quantity
1	250	ST04-4350	Carnivore Tip Elevators, Straight , 2.5 mm, 15 cm / 6"	1
2	241	ST04-3360	Elevator, Stubby Handle, 1 mm Tip, Straight	1
3	241	ST04-3370	Elevator, Stubby Handle, 2 mm Tip, Straight	1
4	225	ST04-1950	Probe/explorer, Double Ended	1
5	236	ST04-2870	Very Fine Periosteal Elevator, Double Ended, 2 / 2 mm	1
6	217	ST04-1300	Resorptive Lesion Probe	1
7	214	ST04-0940	Sickle Scaler, Double Ended	1
8	220	ST04-1690	Curette, Double Ended	1
9	204	ST04-0110	Extraction Forceps, Small	1

### Basic Oral Surgery Kit **ST10-0068**

S. No.	Page No.	Item No.	Description	Quantity
1	249	ST04-4320	Heidbrink Root Tip Elevator, Straight	1
2	204	ST04-0130	Small Breed Forceps For Upper Incisors & Canines Fig. 137	1
3	206	ST04-0230	Small Breed Forceps For Upper Molar Fig. 3	1
4	261	ST04-5170	University of Minnesota, Retractor	1
5	236	ST04-2870	Molt Periosteal Elevators, 2 / 2 mm	1
6	250	ST04-4380	Coupland Elevator, 2.0 mm, 15 cm / 6"	1
7	250	ST04-4381	Coupland Elevator, 2.5 mm, 15 cm / 6"	1
8	250	ST04-4382	Coupland Elevator, 3.0 mm, 15 cm / 6"	1

### Feline Tartar Scraping-Mouth Cleaning Kit **ST10-0069**

S. No.	Page No.	Item No.	Description	Quantity
1	211	ST04-0530	Canine Tartar Removal Scalars	8
2	224	ST04-1890	Dental Mirror	1
3	31	ST02-1710	College Tweezers, Fig. 2, 16 cm / 6¼"	1
4	202	ST04-0030	Mouth Gag, 7 cm / 2¼", Extra small	1
5	202	ST04-0010	Mini Mouth Gag, 13 cm / 5" (for Small Cats)	1
6	378		Instrument Case : Make Your Choice From Page No 378	1

### Dog Dental Extraction Kit **ST10-0070**

S. No.	Page No.	Item No.	Description	Quantity
1	7	ST02-0001	Standard Scalpel Handle # 3, Solid	1
2	95	ST02-5061	Olsen-Hegar Needle Holder TC, 16 cm / 6¼"	1
3	23	ST02-0950	Mayo Scissors TC, 15 cm / 6"	1
4	18	ST02-0665	La Grange Scissors, Curved, One Blade Serrated, 11 cm / 4¼"	1



S. No.	Page No.	Item No.	Description	Quantity
5	236	ST04-2870	Molt Periosteal Elevator, 16 cm / 6¼"	1
6	34	ST02-1907	Halsted-Mosquito Forceps, Curved, 12.5 cm / 4"	1
7	34	ST02-1906	Halsted-Mosquito Forceps, Straight, 12.5 cm / 4"	1
8	31	ST02-1710	College Tweezers, 16 cm / 6½"	1
9	32	ST02-1741	Adson Tissue Forceps, 12 cm / 4¾", 1 x 2 Teeth	1
10	30	ST02-1610	Adson-Brown Tissue Forceps, 12 cm / 4¾", 7 x 8 Teeth	1
11	252	ST04-4451	Elevator, Straight, 3 mm Tip	1
12	250	ST04-4380	Coupland Elevator, Angled Tip 2 mm, 15 cm / 6"	1
13	252	ST04-4453	Elevator, Straight, 5 mm Tip	1
14	250	ST04-4382	Coupland Elevator, Angled Tip 3 mm, 15 cm / 6"	1
15	208	ST04-0340	Klein Forceps For Upper Incisors & Canines, Fig. 137	1
16	208	ST04-0325	Extraction Forceps For Upper Molar, Fig. 137	1
17	208	ST04-0320	Cryer Extraction Forceps, Fig. 150s	1
18	208	ST04-0335	Cryer Extraction Forceps, 151s	1

### ST10-0071 Dog Tartar Scrapping - Mouth Cleaning Kit For Large Dogs

S. No.	Page No.	Item No.	Description	Quantity
1	211	ST04-0530	Canine Tartar Removal Scalars	1
2	224	ST04-1890	Dental Mirror	1
3	34	ST04-1906	Halsted-Mosquito Forceps, Straight, 12.5 cm / 4¾"	1
4	31	ST02-1710	College Tweezers, 16 cm / 6¼"	1
5	202	ST04-0024	Mouth Gag, 18 cm / 7"	1
	378		Instrument Case : Make Your Choice From Page No 378	

### ST10-0072 Dog Tartar Scrapping For Medium Dogs

S. No.	Page No.	Item No.	Description	Quantity
1	211	ST04-0530	Canine Tartar Removal Scalars	1
2	224	ST04-1890	Dental Mirror	1
3	31	ST02-1710	College Tweezers, 16 cm / 6¼"	1
4	202	ST04-0024	Mouth Gag, 14 cm / 5½"	1
5	378		Instrument Case : Make Your Choice From Page No 378	1

### ST10-0073 Tartar Scraping Kit For Small Dogs

S. No.	Page No.	Item No.	Description	Quantity
1	211	ST04-0530	Canine Tartar Removal Scalars	1
2	224	ST04-1890	Dental Mirror	1
3	31	ST02-1710	College Tweezers, 16 cm / 6¼"	1
4	202	ST04-0022	Mouth Gag, 11 cm / 4¼"	1
5	378		Instrument Case : Make Your Choice From Page No 378	1

### ST10-0074 Canine Periodontal Instrument Pack

S. No.	Page No.	Item No.	Description	Quantity
1	225	ST04-1990	Mouth Mirror Handle	1
2	224	ST04-1920	Mouth Mirror # 4	1
3	219A	ST04-1565	Explorer 17/23	1
4	219A	ST04-1575	Columbia Curette 13 /14	1
5	219A	ST04-1570	Columbia Curette 4R / 4L	1
6	219B	ST04-1591	Gracey Explorer 11 / 12	1
7	219B	ST04-1585	Towner Jacquette 15 / 30	1

**Periodontal Instrument Pack ST10-0075**

S. No.	Page No.	Item No.	Description	Quantity
1	223	ST04-1840	Dental Laryngeal Mirror, Size 4, Double Ended	1
2	225	ST04-1980	Dental Laryngeal Mirror, Size 3	1
3	102	ST03-0180	Periodontal Elevator Double Ended	1
4	216	ST04-1160	Jacquette Scaler	1
5	222	ST04-1800	Morse Scaler	1
6	219A	ST04-1575	Columbia Curette, No. 13/14	1
7	219B	ST04-1590	Gracey Curette, No. 1/2	1
8	261	ST04-5130	Sharpening Stone	1
9	378		Instrument Case : Make Your Choice From Page No 378	1

**Root Removal Forceps ST10-0076**

S. No.	Page No.	Item No.	Description	Quantity
1	209	ST04-0350	Root Removal Forceps, Fragment, No.1, 175 mm	1
2	209	ST04-0360	Root Removal Forceps, Fragment, No.2, 175 mm	1
3	209	ST04-0370	Root Removal Forceps, Fragment, No.3, 150 mm	1
4	378		Instrument Case : Make Your Choice From Page No 378	1

**Delwbasic - Winged Dental Elevator Basic Kit ST10-0077**

S. No.	Page No.	Item No.	Description	Quantity
1	238	ST04-3130	Winged Elevator, 2 mm	1
2	238	ST04-3140	Winged Elevator, 3 mm	1
3	238	ST04-3150	Winged Elevator, 4 mm	1
4	238	ST04-3160	Winged Elevator, 5 mm	1
5	378		Instrument Case : Make Your Choice From Page No 378	1

**Delwdelux - Winged Dental Elevator Deluxe Kit ST10-0078**

S. No.	Page No.	Item No.	Description	Quantity
1	238	ST04-3130	Winged Elevator, 2 mm	1
2	238	ST04-3140	Winged Elevator, 3 mm	1
3	238	ST04-3150	Winged Elevator, 4 mm	1
4	238	ST04-3160	Winged Elevator, 5 mm	1
5	238	ST04-3170	Winged Elevator, 6 mm	1
6	238	ST04-3171	Winged Elevator, 7 mm	1
7	238	ST04-3172	Winged Elevator, 8 mm	1
8	378		Instrument Case : Make Your Choice From Page No 378	1

**Winged Elevators - Stubby Handle ST10-0079**

S. No.	Page No.	Item No.	Description	Quantity
1	238	ST04-3060	Winged Elevator, Stubby Handle, 1 mm	1
2	238	ST04-3070	Winged Elevator, Stubby Handle, 2 mm	1
3	238	ST04-3080	Winged Elevator, Stubby Handle, 3 mm	1
4	238	ST04-3090	Winged Elevator, Stubby Handle, 4 mm	1
5	238	ST04-3100	Winged Elevator, Stubby Handle, 5 mm	1
6	238	ST04-3110	Winged Elevator, Stubby Handle, 6 mm	1
7	378		Instrument Case : Make Your Choice From Page No 378	1

**Winged Elevators - Ferrozell Colored Handle ST10-0080**

S. No.	Page No.	Item No.	Description	Quantity
1	240	ST04-3330	Winged Elevator, Ferrozell Handle, 1 mm	1

S. No.	Page No.	Item No.	Description	Quantity
2	240	ST04-3331	Winged Elevator, Ferrozell Handle, 2 mm	1
3	240	ST04-3332	Winged Elevator, Ferrozell Handle, 3 mm	1
4	240	ST04-3333	Winged Elevator, Ferrozell Handle, 4 mm	1
5	240	ST04-3334	Winged Elevator, Ferrozell Handle, 5 mm	1
6	240	ST04-3335	Winged Elevator, Ferrozell Handle, 6 mm	1
7	378		Instrument Case : Make Your Choice From Page No 378	1

### ST10-0081 Winged Elevators - Annodised Colored Handle

S. No.	Page No.	Item No.	Description	Quantity
1	239	ST04-3180	Winged Elevator, Handle, 1 mm	1
2	239	ST04-3190	Winged Elevator, Golden Handle, 2 mm	1
3	239	ST04-3200	Winged Elevator, Blue Handle, 3 mm	1
4	239	ST04-3210	Winged Elevator, Black Handle, 4 mm	1
5	239	ST04-3220	Winged Elevator, Pink Handle, 5 mm	1
6	239	ST04-3230	Winged Elevator, Green Handle, 6 mm	1
7	378		Instrument Case : Make Your Choice From Page No 378	1

### ST10-0082 Winged Elevator Set - Very Slim Handle

S. No.	Page No.	Item No.	Description	Quantity
1	239	ST04-3240	Winged Elevator, Very Slim Handle, 1 mm	1
2	239	ST04-3250	Winged Elevator, Very Slim Handle, 2 mm	1
3	239	ST04-3260	Winged Elevator, Very Slim Handle, 3 mm	1
4	239	ST04-3270	Winged Elevator, Very Slim Handle, 4 mm	1
5	239	ST04-3280	Winged Elevator, Very Slim Handle, 5 mm	1
6	239	ST04-3290	Winged Elevator, Very Slim Handle, 6 mm	1
7	368		Instrument Case : Make Your Choice From Page No 378	1

### ST10-0083 Winged Elevator Set - Standard Handle

S. No.	Page No.	Item No.	Description	Quantity
1	238	ST04-3120	Winged Elevator, Standard Handle, 1 mm	1
2	238	ST04-3130	Winged Elevator, Standard Handle, 2 mm	1
3	238	ST04-3140	Winged Elevator, Standard Handle, 3 mm	1
4	238	ST04-3150	Winged Elevator, Standard Handle, 4 mm	1
5	378		Instrument Case : Make Your Choice From Page No 378	1

### ST10-0084 Winged Elevator Set - Stubby Handle

S. No.	Page No.	Item No.	Description	Quantity
1	238	ST04-3060	Winged Elevator, Stubby Handle, 1 mm	1
2	238	ST04-3070	Winged Elevator, Stubby Handle, 2 mm	1
3	238	ST04-3080	Winged Elevator, Stubby Handle, 3 mm	1
4	238	ST04-3090	Winged Elevator, Stubby Handle, 4 mm	1
5	378		Instrument Case : Make Your Choice From Page No 378	1

### ST10-0085 Winged Elevator Set - Standard Handle

S. No.	Page No.	Item No.	Description	Quantity
1	238	ST04-3120	Winged Elevator, Standard Handle, 1 mm	1
2	238	ST04-3130	Winged Elevator, Standard Handle, 2 mm	1
3	238	ST04-3140	Winged Elevator, Standard Handle, 3 mm	1
4	238	ST04-3150	Winged Elevator, Standard Handle, 4 mm	1

S. No.	Page No.	Item No.	Description	Quantity
5	238	ST04-3160	Winged Elevator, Standard Handle, 5 mm	1
6	238	ST04-3170	Winged Elevator, Standard Handle, 6 mm	1
7	378		Instrument Case : Make Your Choice From Page No 378	1

### Winged Elevator Set - Stubby Handle **ST10-0086**

S. No.	Page No.	Item No.	Description	Quantity
1	238	ST04-3060	Winged Elevator, Stubby Handle, 1 mm	1
2	238	ST04-3070	Winged Elevator, Stubby Handle, 2 mm	1
3	238	ST04-3080	Winged Elevator, Stubby Handle, 3 mm	1
4	238	ST04-3090	Winged Elevator, Stubby Handle, 4 mm	1
5	238	ST04-3100	Winged Elevator, Stubby Handle, 5 mm	1
6	238	ST04-3010	Winged Elevator, Stubby Handle, 6 mm	1
7	378		Instrument Case : Make Your Choice From Page No 378	1

### Winged Elevator Set - Stubby Handle **ST10-0087**

S. No.	Page No.	Item No.	Description	Quantity
1	238	ST04-3060	Winged Elevator With Stubby Handle, 1 mm	1
2	238	ST04-3070	Winged Elevator With Stubby Handle, 2 mm	1
3	238	ST04-3080	Winged Elevator With Stubby Handle, 3 mm	1
4	238	ST04-3090	Winged Elevator With Stubby Handle, 4 mm	1
5	238	ST04-3100	Winged Elevator With Stubby Handle, 5 mm	1
6	238	ST04-3110	Winged Elevator With Stubby Handle, 6 mm	1
7	238	ST04-3111	Winged Elevator With Stubby Handle, 7 mm	1
8	238	ST04-3112	Winged Elevator With Stubby Handle, 8 mm	1
9	378		Instrument Case : Make Your Choice From Page No 378	1

### Luxator Instruments Set - Stubby Handle **ST10-0088**

S. No.	Page No.	Item No.	Description	Quantity
1	241	ST04-3360	Luxator, Stubby Handle, 1 mm, Straight, 11.5 cm / 4½"	1
2	241	ST04-3370	Luxator, Stubby Handle, 2 mm, Straight, 11.5 cm / 4½"	1
3	241	ST04-3380	Luxator, Stubby Handle, 3 mm, Straight, 11.5 cm / 4½"	1
4	241	ST04-3390	Luxator, Stubby Handle, 4 mm, Straight, 11.5 cm / 4½"	1
5	241	ST04-3400	Luxator, Stubby Handle, 5 mm, Straight, 11.5 cm / 4½"	1

### Luxating Dental Elevator Kit **ST10-0089**

S. No.	Page No.	Item No.	Description	Quantity
1	241	ST04-3371	Luxating Elevator, Curved, 2 mm, 11.5 cm / 4½"	1
2	241	ST04-3381	Luxating Elevator, Curved, 3 mm, 11.5 cm / 4½"	1
3	241	ST04-3391	Luxating Elevator, Curved, 4 mm, 11.5 cm / 4½"	1
4	241	ST04-3401	Luxating Elevator, Curved, 5 mm, 11.5 cm / 4½"	1
5	241	ST04-3370	Luxating Elevator, Straight, 2 mm, 11.5 cm / 4½"	1
6	241	ST04-3380	Luxating Elevator, Straight, 3 mm, 11.5 cm / 4½"	1
7	241	ST04-3390	Luxating Elevator, Straight, 4 mm, 11.5 cm / 4½"	1
8	241	ST04-3400	Luxating Elevator, Straight, 5 mm, 11.5 cm / 4½"	1
9	378		Instrument Case : Make Your Choice From Page No 378	1

### Luxating Elevators - Ferrozell Handle **ST10-0090**

S. No.	Page No.	Item No.	Description	Quantity
1	244	ST04-3750	Luxating Elevator, Ferrozell Handle, 1 mm	1

S. No.	Page No.	Item No.	Description	Quantity
2	244	ST04-3760	Luxating Elevator, Ferrozell Handle, 2 mm	1
3	244	ST04-3770	Luxating Elevator, Ferrozell Handle, 3 mm	1
4	244	ST04-3780	Luxating Elevator, Ferrozell Handle, 4 mm	1
5	244	ST04-3790	Luxating Elevator, Ferrozell Handle, 5 mm	1
6	244	ST04-3800	Luxating Elevator, Ferrozell Handle, 6 mm	1
7	378		Instrument Case : Make Your Choice From Page No 378	1

**ST10-0091 Luxating Elevators - Anodised Colored Handle**

S. No.	Page No.	Item No.	Description	Quantity
1	242	ST04-3480	Luxating Elevator, Indigo Handle, 1 mm	1
2	242	ST04-3490	Luxating Elevator, Golden Handle, 2 mm	1
3	242	ST04-3500	Luxating Elevator, Blue Handle, 3 mm	1
4	242	ST04-3510	Luxating Elevator, Black Handle, 4 mm	1
5	242	ST04-3520	Luxating Elevator, Pink Handle, 5 mm	1
6	242	ST04-3530	Luxating Elevator, Green Handle, 6 mm	1
7	378		Instrument Case : Make Your Choice From Page No 378	1

**ST10-0092 Luxating Elevators - Very Slim Handle**

S. No.	Page No.	Item No.	Description	Quantity
1	242	ST04-3540	Luxating Elevator, Very Slim Handle, 1 mm	1
2	242	ST04-3541	Luxating Elevator, Very Slim Handle, 2 mm	1
3	242	ST04-3542	Luxating Elevator, Very Slim Handle, 3 mm	1
4	242	ST04-3543	Luxating Elevator, Very Slim Handle, 4 mm	1
5	242	ST04-3544	Luxating Elevator, Very Slim Handle, 5 mm	1
6	242	ST04-3545	Luxating Elevator, Very Slim Handle, 6 mm	1
7	378		Instrument Case : Make Your Choice From Page No 378	1

**ST10-0093 Pointed Elevator Set - Standard Handle**

S. No.	Page No.	Item No.	Description	Quantity
1	238	ST04-3120	Pointed Elevator, Standard Handle, 1 mm	1
2	238	ST04-3130	Pointed Elevator, Standard Handle, 2 mm	1
3	238	ST04-3140	Pointed Elevator, Standard Handle, 3 mm	1
4	238	ST04-3150	Pointed Elevator, Standard Handle, 4 mm	1
5	238	ST04-3160	Pointed Elevator, Standard Handle, 5 mm	1
6	238	ST04-3170	Pointed Elevator, Standard Handle, 6 mm	1
7	238	ST04-3171	Pointed Elevator, Standard Handle, 7 mm	1
8	238	ST04-3172	Pointed Elevator, Standard Handle, 8 mm	1
9	378		Instrument Case : Make Your Choice From Page No 378	1

**ST10-0094 Pointed Elevator Set - Stubby Handle**

S. No.	Page No.	Item No.	Description	Quantity
1	238	ST04-3060	Pointed Elevator, Stubby Handle, 1 mm	1
2	238	ST04-3070	Pointed Elevator, Stubby Handle, 2 mm	1
3	238	ST04-3080	Pointed Elevator, Stubby Handle, 3 mm	1
4	238	ST04-3090	Pointed Elevator, Stubby Handle, 4 mm	1
5	238	ST04-3100	Pointed Elevator, Stubby Handle, 5 mm	1
6	238	ST04-3110	Pointed Elevator, Stubby Handle, 6 mm	1
7	238	ST04-3111	Pointed Elevator, Stubby Handle, 7 mm	1
8	238	ST04-3112	Pointed Elevator, Stubby Handle, 8 mm	1
9	378		Instrument Case : Make Your Choice From Page No 378	1

**Serrated Elevator Set - Standard Handle ST10-0095**

S. No.	Page No.	Item No.	Description	Quantity
1	246	ST04-3920	Serrated Elevator, Standard Handle, 1 mm	1
2	246	ST04-3925	Serrated Elevator, Standard Handle, 2 mm	1
3	246	ST04-3930	Serrated Elevator, Standard Handle, 3 mm	1
4	246	ST04-3935	Serrated Elevator, Standard Handle, 4 mm	1
5	246	ST04-3940	Serrated Elevator, Standard Handle, 5 mm	1
6	246	ST04-3950	Serrated Elevator, Standard Handle, 6 mm	1

**Serrated Elevator Set - Stubby Handle ST10-0096**

S. No.	Page No.	Item No.	Description	Quantity
1	246	ST04-3960	Serrated Elevator, Stubby Handle, 1 mm	1
2	246	ST04-3970	Serrated Elevator, Stubby Handle, 2 mm	1
3	246	ST04-3980	Serrated Elevator, Stubby Handle, 3 mm	1
4	246	ST04-3990	Serrated Elevator, Stubby Handle, 4 mm	1
5	246	ST04-4000	Serrated Elevator, Stubby Handle, 5 mm	1
6	246	ST04-4010	Serrated Elevator, Stubby Handle, 6 mm	1

**Mouth Gags Set 1 ST10-0097**

S. No.	Page No.	Item No.	Description	Quantity
1	202	ST04-0001	Mouth Gags, Extra Small, 5 cm / 2"	1
2	202	ST04-0002	Mouth Gags, Small, 8 cm / 3"	1
3	202	ST04-0003	Mouth Gags, Medium, 12 cm / 4¾"	1

**Mouth Gags Set 2 ST10-0098**

S. No.	Page No.	Item No.	Description	Quantity
1	202	ST04-0010	Mouth Gags, XX Small, 5.5 cm / 2¼"	1
2	202	ST04-0011	Mouth Gags, Extra Small, 6.5 cm / 2½"	1
3	202	ST04-0012	Mouth Gags, Small, 10 cm / 4"	1
4	202	ST04-0013	Mouth Gags, Medium, 14 cm / 5½"	1
5	202	ST04-0014	Mouth Gags, Large, 15.5 cm / 6"	1
6	202	ST04-0015	Mouth Gags, Extra Large, 17 cm / 6¾"	1

**Mouth Gags Set 3 ST10-0099**

S. No.	Page No.	Item No.	Description	Quantity
1	202	ST04-0020	Mouth Gags, Extra Small, 6 cm / 2½"	1
2	202	ST04-0021	Mouth Gags, Small, 9 cm / 3½"	1
3	202	ST04-0022	Mouth Gags, Medium, 11 cm / 4¼"	1
4	202	ST04-0023	Mouth Gags, Large, 14 cm / 5½"	1
5	202	ST04-0024	Mouth Gags, Extra Large, 18 cm / 7"	1

**Mouth Gags Set 4 ST10-0100**

S. No.	Page No.	Item No.	Description	Quantity
1	202	ST04-0030	Mouth Gags, Extra Small, 7 cm / 2¾"	1
2	202	ST04-0031	Mouth Gags, Small, 9 cm / 3½"	1
3	202	ST04-0032	Mouth Gags, Medium, 12 cm / 4¾"	1
4	202	ST04-0033	Mouth Gags, Large, 17 cm / 6¾"	1

**ST10-0101 Mouth Gags Set 5**

S. No.	Page No.	Item No.	Description	Quantity
1	202	ST04-0040	Mouth Gags, Extra Small, 4 cm / 1½"	1
2	202	ST04-0041	Mouth Gags, Small, 6.5 cm / 2½"	1
3	202	ST04-0042	Mouth Gags, Medium, 10 cm / 4"	1
4	202	ST04-0043	Mouth Gags, Large, 14 cm / 5½"	1
5	202	ST04-0044	Mouth Gags, Extra Large, 18 cm / 7"	1

**ST10-0102 Mouth Gags Set 6**

S. No.	Page No.	Item No.	Description	Quantity
1	202	ST04-0050	Mouth Gags, Extra Small, 6 cm / 2½"	1
2	202	ST04-0051	Mouth Gags, Small, 11 cm / 4¼"	1
3	202	ST04-0052	Mouth Gags, Medium, 14 cm / 5½"	1
4	202	ST04-0053	Mouth Gags, Large, 18 cm / 7"	1

**ST10-0103 Periotome Kit**

S. No.	Page No.	Item No.	Description	Quantity
1	230	ST04-2500	Periotome, Straight, Double Ended	1
2	230	ST04-2502	Periotome, Hatchet, Double Ended	1
3	230	ST04-2501	Periotome, Hoe, Double Ended	1
4	378		Instrument Case : Make Your Choice From Page No 378	1

**ST10-0104 Complete Rabbit and Rodent Kit**

S. No.	Page No.	Item No.	Description	Quantity
1	257	ST04-4760	Molar Incisor Luxator	1
2	257	ST04-4790	Molar Luxator	1
3	256	ST04-4720	Rodent Spatula	1
4	255	ST04-4621	Cheek Dilator - Small	1
5	255	ST04-4623	Cheek Dilator - Large	1
6	254	ST04-4590	Rodent Wire Mouth Gag	1
7	254	ST04-4550	Rodent Mouth Gag	1
8	260	ST04-5050	Cheek Teeth Extraction Forceps (molar Teeth)	1
9	378		Instrument Case : Make Your Choice From Page No 378	1

**ST10-0105 Rabbit / Rodent Starter Kit**

S. No.	Page No.	Item No.	Description	Quantity
1	202	ST04-0021	Mouth Gag, Small, 9 cm / 3½"	1
2	255	ST04-4622	Cheek Dilators, Medium	1
3	260	ST04-5060	Rodent Dental Molar Cutters	1
4	256	ST04-4720	Mouth Specula	1
5	283	ST05-0900	Molar Rasp For Floating Teeth, 35 cm / 13¾"	1
6	378		Instrument Case : Make Your Choice From Page No 378	1

**ST10-0106 Guillotine Cat Nail Clipper Kit**

S. No.	Page No.	Item No.	Description	Quantity
1	354	ST06-2410	Cat's Nail Clipper	1
2	354	ST06-2381	Nail File, 12 cm / 4¾"	1
3	378		Instrument Case : Make Your Choice From Page No 378	1

# Index

## By Code

**Index**  
By Code



Item Code	Page	Item Code	Page	Item Code	Page	Item Code	Page	Item Code	Page
ST01-0001	1	ST01-0251	4	ST02-0122	8	ST02-0248	11	ST02-0304	12B
ST01-0010	1	ST01-0252	4	ST02-0130	8	ST02-0249	11	ST02-0306	12B
ST01-0011	1	ST01-0260	5	ST02-0131	8	ST02-0250	11	ST02-0308	12B
ST01-0012	1	ST01-0261	5	ST02-0150	9	ST02-0251	11	ST02-0320	13
ST01-0013	1	ST01-0262	5	ST02-0160	9	ST02-0252	11	ST02-0321	13
ST01-0020	1	ST01-0263	5	ST02-0161	9	ST02-0253	11	ST02-0322	13
ST01-0030	2	ST01-0270	5	ST02-0162	9	ST02-0254	11	ST02-0323	13
ST01-0040	2	ST01-0271	5	ST02-0163	9	ST02-0255	11	ST02-0324	13
ST01-0050	2	ST01-0272	5	ST02-0164	9	ST02-0260	12	ST02-0325	13
ST01-0060	2	ST01-0273	5	ST02-0165	9	ST02-0261	12	ST02-0326	13
ST01-0070	2	ST01-0274	5	ST02-0166	9	ST02-0262	12	ST02-0327	13
ST01-0075	2	ST01-0280	5	ST02-0167	9	ST02-0263	12	ST02-0340	13
ST01-0080	2	ST01-0281	5	ST02-0168	9	ST02-0264	12	ST02-0341	13
ST01-0090	2	ST01-0282	5	ST02-0169	9	ST02-0265	12	ST02-0342	13
ST01-0100	3	ST01-0290	5	ST02-0180	10	ST02-0266	12	ST02-0343	13
ST01-0110	3	ST01-0291	5	ST02-0181	10	ST02-0267	12	ST02-0344	13
ST01-0115	3	ST01-0292	5	ST02-0182	10	ST02-0268	12	ST02-0345	13
ST01-0120	3	ST01-0300	5	ST02-0183	10	ST02-0269	12	ST02-0346	13
ST01-0130	3	ST01-0301	5	ST02-0184	10	ST02-0270	12	ST02-0347	13
ST01-0131	3	ST01-0302	5	ST02-0185	10	ST02-0271	12	ST02-0348	13
ST01-0140	3	ST01-0310	5	ST02-0186	10	ST02-0272	12	ST02-0349	13
ST01-0141	3	ST01-0311	5	ST02-0187	10	ST02-0273	12	ST02-0360	13
ST01-0142	3	ST01-0312	5	ST02-0188	10	ST02-0280	12	ST02-0361	13
ST01-0143	3	ST01-0320	5	ST02-0189	10	ST02-0281	12	ST02-0370	13
ST01-0150	3	ST01-0321	5	ST02-0195	10	ST02-0282	12	ST02-0371	13
ST01-0151	3	ST01-0322	5	ST02-0200	11	ST02-0283	12	ST02-0380	14
ST01-0152	3	ST01-0330	5	ST02-0201	11	ST02-0284	12	ST02-0381	14
ST01-0153	3	ST01-0331	5	ST02-0202	11	ST02-0285	12	ST02-0390	14
ST01-0154	3	ST01-0332	5	ST02-0203	11	ST02-0286	12	ST02-0391	14
ST01-0155	3	ST01-0340	6	ST02-0204	11	ST02-0287	12	ST02-0400	14
ST01-0160	4	ST01-0341	6	ST02-0205	11	ST02-0288	12	ST02-0401	14
ST01-0161	4	ST01-0342	6	ST02-0206	11	ST02-0289	12	ST02-0402	14
ST01-0162	4	ST01-0343	6	ST02-0207	11	ST02-0290	12	ST02-0403	14
ST01-0163	4	ST01-0350	6	ST02-0208	11	ST02-0291	12	ST02-0404	14
ST01-0170	4	ST01-0351	6	ST02-0209	11	ST02-0292	12	ST02-0405	14
ST01-0171	4	ST01-0360	6	ST02-0210	11	ST02-0293	12	ST02-0410	14
ST01-0172	4	ST01-0361	6	ST02-0211	11	ST02-0300	12	ST02-0411	14
ST01-0173	4	ST01-0362	6	ST02-0212	11	ST02-0301	12	ST02-0412	14
ST01-0180	4	ST01-0363	6	ST02-0213	11	ST02-0302	12	ST02-0413	14
ST01-0181	4	ST01-0364	6	ST02-0214	11	ST02-0303	12	ST02-0414	14
ST01-0182	4	ST01-0365	6	ST02-0215	11	ST02-0304	12	ST02-0415	14
ST01-0183	4	ST01-0366	6	ST02-0220	11	ST02-0305	12	ST02-0420	14
ST01-0190	4	ST01-0367	6	ST02-0221	11	ST02-0306	12	ST02-0421	14
ST01-0191	4	ST01-0368	6	ST02-0222	11	ST02-0307	12	ST02-0422	14
ST01-0192	4	ST01-0380	6	ST02-0223	11	ST02-0308	12	ST02-0423	14
ST01-0193	4	ST01-0390	6	ST02-0224	11	ST02-0309	12	ST02-0424	14
ST01-0200	4	ST01-0391	6	ST02-0225	11	ST02-0310	12	ST02-0425	14
ST01-0201	4	ST01-0400	6	ST02-0226	11	ST02-0311	12	ST02-0430	15
ST01-0202	4	ST01-0401	6	ST02-0227	11	ST02-0312	12	ST02-0431	15
ST01-0203	4	ST02-0001	7	ST02-0228	11	ST02-0313	12	ST02-0432	15
ST01-0210	4	ST02-0010	7	ST02-0229	11	ST02-0204A	12A	ST02-0433	15
ST01-0211	4	ST02-0020	7	ST02-0230	11	ST02-0206A	12A	ST02-0434	15
ST01-0212	4	ST02-0030	7	ST02-0231	11	ST02-0208A	12A	ST02-0435	15
ST01-0213	4	ST02-0031	7	ST02-0232	11	ST02-0224A	12A	ST02-0440	15
ST01-0220	4	ST02-0040	7	ST02-0233	11	ST02-0226A	12A	ST02-0441	15
ST01-0221	4	ST02-0050	7	ST02-0234	11	ST02-0228A	12A	ST02-0442	15
ST01-0222	4	ST02-0060	7	ST02-0235	11	ST02-0244A	12A	ST02-0443	15
ST01-0223	4	ST02-0070	8	ST02-0240	11	ST02-0246A	12A	ST02-0444	15
ST01-0230	4	ST02-0080	8	ST02-0241	11	ST02-0248A	12A	ST02-0445	15
ST01-0231	4	ST02-0090	8	ST02-0242	11	ST02-0264A	12B	ST02-0450	15
ST01-0232	4	ST02-0100	8	ST02-0243	11	ST02-0266A	12B	ST02-0451	15
ST01-0240	4	ST02-0101	8	ST02-0244	11	ST02-0268A	12B	ST02-0452	15
ST01-0241	4	ST02-0110	8	ST02-0245	11	ST02-0284	12B	ST02-0453	15
ST01-0242	4	ST02-0120	8	ST02-0246	11	ST02-0286	12B	ST02-0460	15
ST01-0250	4	ST02-0121	8	ST02-0247	11	ST02-0288	12B	ST02-0461	15

Item Code	Page	Item Code	Page	Item Code	Page	Item Code	Page	Item Code	Page
ST02-0462	15	ST02-0643	18	ST02-0839	22	ST02-0952	23	ST02-1045	24
ST02-0463	15	ST02-0650	18	ST02-0840	22	ST02-0953	23	ST02-1046	24
ST02-0464	15	ST02-0651	18	ST02-0841	22	ST02-0954	23	ST02-1047	24
ST02-0465	15	ST02-0660	18	ST02-0842	22	ST02-0955	23	ST02-1048	24
ST02-0470	15	ST02-0665	18	ST02-0843	22	ST02-0956	23	ST02-1049	24
ST02-0471	15	ST02-0670	19	ST02-0844	22	ST02-0957	23	ST02-1050	24
ST02-0472	15	ST02-0671	19	ST02-0845	22	ST02-0958	23	ST02-1051	24
ST02-0473	15	ST02-0672	19	ST02-0846	22	ST02-0959	23	ST02-1052	24
ST02-0474	15	ST02-0673	19	ST02-0847	22	ST02-0960	23	ST02-1053	24
ST02-0475	15	ST02-0674	19	ST02-0860	22	ST02-0961	23	ST02-1054	24
ST02-0480	15	ST02-0675	19	ST02-0861	22	ST02-0970	23	ST02-1055	24
ST02-0481	15	ST02-0676	19	ST02-0862	22	ST02-0971	23	ST02-1056	24
ST02-0490	16	ST02-0677	19	ST02-0863	22	ST02-0972	23	ST02-1057	24
ST02-0491	16	ST02-0690	19	ST02-0864	22	ST02-0973	23	ST02-1058	24
ST02-0492	16	ST02-0691	19	ST02-0865	22	ST02-0974	23	ST02-1059	24
ST02-0493	16	ST02-0700	19	ST02-0866	22	ST02-0975	23	ST02-1060	24
ST02-0500	16	ST02-0710	19	ST02-0867	22	ST02-0976	23	ST02-1061	24
ST02-0501	16	ST02-0711	19	ST02-0868	22	ST02-0977	23	ST02-1062	24
ST02-0502	16	ST02-0712	19	ST02-0869	22	ST02-0978	23	ST02-1063	24
ST02-0503	16	ST02-0713	19	ST02-0870	22	ST02-0979	23	ST02-1080	25
ST02-0510	16	ST02-0720	20	ST02-0871	22	ST02-0980	23	ST02-1081	25
ST02-0511	16	ST02-0721	20	ST02-0872	22	ST02-0981	23	ST02-1082	25
ST02-0512	16	ST02-0730	20	ST02-0873	22	ST02-0990	23	ST02-1083	25
ST02-0513	16	ST02-0740	20	ST02-0874	22	ST02-0991	23	ST02-1084	25
ST02-0520	16	ST02-0750	20	ST02-0875	22	ST02-0992	23	ST02-1085	25
ST02-0521	16	ST02-0760	21	ST02-0876	22	ST02-0993	23	ST02-1086	25
ST02-0522	16	ST02-0761	21	ST02-0877	22	ST02-0994	23	ST02-1087	25
ST02-0523	16	ST02-0762	21	ST02-0890	22	ST02-0995	23	ST02-1088	25
ST02-0530	16	ST02-0763	21	ST02-0891	22	ST02-1000	23	ST02-1089	25
ST02-0540	16	ST02-0764	21	ST02-0892	22	ST02-1001	23	ST02-1090	25
ST02-0550	16	ST02-0765	21	ST02-0893	22	ST02-1002	23	ST02-1091	25
ST02-0551	16	ST02-0770	21	ST02-0894	22	ST02-1003	23	ST02-1092	25
ST02-0560	17	ST02-0771	21	ST02-0895	22	ST02-1004	23	ST02-1093	25
ST02-0561	17	ST02-0772	21	ST02-0896	22	ST02-1005	23	ST02-1094	25
ST02-0570	17	ST02-0773	21	ST02-0897	22	ST02-1006	23	ST02-1095	25
ST02-0571	17	ST02-0774	21	ST02-0898	22	ST02-1007	23	ST02-1096	25
ST02-0572	17	ST02-0775	21	ST02-0899	22	ST02-1008	23	ST02-1097	25
ST02-0573	17	ST02-0780	21	ST02-0900	22	ST02-1009	23	ST02-1098	25
ST02-0574	17	ST02-0781	21	ST02-0901	22	ST02-1010	23	ST02-1099	25
ST02-0575	17	ST02-0782	21	ST02-0902	22	ST02-1011	23	ST02-1100	25
ST02-0576	17	ST02-0790	21	ST02-0903	22	ST02-1020	24	ST02-1101	25
ST02-0577	17	ST02-0791	21	ST02-0904	22	ST02-1021	24	ST02-1102	25
ST02-0590	17	ST02-0792	21	ST02-0905	22	ST02-1022	24	ST02-1103	25
ST02-0591	17	ST02-0793	21	ST02-0906	22	ST02-1023	24	ST02-1104	25
ST02-0592	17	ST02-0794	21	ST02-0907	22	ST02-1024	24	ST02-1105	25
ST02-0593	17	ST02-0795	21	ST02-0920	22	ST02-1025	24	ST02-1106	25
ST02-0600	17	ST02-0796	21	ST02-0921	22	ST02-1026	24	ST02-1107	25
ST02-0601	17	ST02-0797	21	ST02-0922	22	ST02-1027	24	ST02-1108	25
ST02-0602	17	ST02-0798	21	ST02-0923	22	ST02-1028	24	ST02-1109	25
ST02-0603	17	ST02-0799	21	ST02-0924	22	ST02-1029	24	ST02-1110	25
ST02-0604	17	ST02-0800	21	ST02-0925	22	ST02-1030	24	ST02-1111	25
ST02-0605	17	ST02-0801	21	ST02-0926	22	ST02-1031	24	ST02-1112	25
ST02-0606	17	ST02-0810	21	ST02-0927	22	ST02-1032	24	ST02-1113	25
ST02-0607	17	ST02-0811	21	ST02-0928	22	ST02-1033	24	ST02-1114	25
ST02-0608	17	ST02-0820	21	ST02-0929	22	ST02-1034	24	ST02-1115	25
ST02-0609	17	ST02-0821	21	ST02-0930	22	ST02-1035	24	ST02-1116	25
ST02-0610	17	ST02-0830	22	ST02-0931	22	ST02-1036	24	ST02-1117	25
ST02-0611	17	ST02-0831	22	ST02-0932	22	ST02-1037	24	ST02-1118	25
ST02-0620	18	ST02-0832	22	ST02-0933	22	ST02-1038	24	ST02-1119	25
ST02-0630	18	ST02-0833	22	ST02-0934	22	ST02-1039	24	ST02-1120	25
ST02-0635	18	ST02-0834	22	ST02-0935	22	ST02-1040	24	ST02-1121	25
ST02-0636	18	ST02-0835	22	ST02-0936	22	ST02-1041	24	ST02-1140	25
ST02-0640	18	ST02-0836	22	ST02-0937	22	ST02-1042	24	ST02-1141	25
ST02-0641	18	ST02-0837	22	ST02-0950	23	ST02-1043	24	ST02-1142	25
ST02-0642	18	ST02-0838	22	ST02-0951	23	ST02-1044	24	ST02-1143	25

Item Code	Page	Item Code	Page	Item Code	Page	Item Code	Page	Item Code	Page
ST02-1144	25	ST02-1280	27	ST02-1378	27	ST02-1571	29	ST02-1871	33
ST02-1145	25	ST02-1281	27	ST02-1379	27	ST02-1580	29	ST02-1880	33
ST02-1146	25	ST02-1282	27	ST02-1380	27	ST02-1581	29	ST02-1881	33
ST02-1147	25	ST02-1283	27	ST02-1381	27	ST02-1590	30	ST02-1882	33
ST02-1148	25	ST02-1284	27	ST02-1382	27	ST02-1600	30	ST02-1883	33
ST02-1149	25	ST02-1285	27	ST02-1383	27	ST02-1610	30	ST02-1884	33
ST02-1150	25	ST02-1286	27	ST02-1384	27	ST02-1611	30	ST02-1885	33
ST02-1151	25	ST02-1300	27	ST02-1385	27	ST02-1612	30	ST02-1890	33
ST02-1152	25	ST02-1301	27	ST02-1400	28	ST02-1613	30	ST02-1900	34
ST02-1153	25	ST02-1302	27	ST02-1401	28	ST02-1620	30	ST02-1901	34
ST02-1154	25	ST02-1303	27	ST02-1402	28	ST02-1621	30	ST02-1902	34
ST02-1155	25	ST02-1304	27	ST02-1410	28	ST02-1630	30	ST02-1903	34
ST02-1156	25	ST02-1305	27	ST02-1411	28	ST02-1631	30	ST02-1904	34
ST02-1157	25	ST02-1306	27	ST02-1412	28	ST02-1632	30	ST02-1905	34
ST02-1158	25	ST02-1307	27	ST02-1420	28	ST02-1633	30	ST02-1906	34
ST02-1159	25	ST02-1308	27	ST02-1421	28	ST02-1634	30	ST02-1907	34
ST02-1160	25	ST02-1309	27	ST02-1422	28	ST02-1635	30	ST02-1908	34
ST02-1161	25	ST02-1310	27	ST02-1423	28	ST02-1640	30	ST02-1909	34
ST02-1162	25	ST02-1311	27	ST02-1424	28	ST02-1650	30	ST02-1920	34
ST02-1163	25	ST02-1312	27	ST02-1425	28	ST02-1660	30	ST02-1921	34
ST02-1164	25	ST02-1313	27	ST02-1426	28	ST02-1663	30	ST02-1922	34
ST02-1165	25	ST02-1320	27	ST02-1427	28	ST02-1670	31	ST02-1923	34
ST02-1166	25	ST02-1321	27	ST02-1440	28	ST02-1680	31	ST02-1924	34
ST02-1167	25	ST02-1322	27	ST02-1441	28	ST02-1690	31	ST02-1925	34
ST02-1168	25	ST02-1323	27	ST02-1442	28	ST02-1693	31	ST02-1926	34
ST02-1169	25	ST02-1324	27	ST02-1443	28	ST02-1700	31	ST02-1927	34
ST02-1180	26	ST02-1325	27	ST02-1450	28	ST02-1701	31	ST02-1928	34
ST02-1181	26	ST02-1326	27	ST02-1451	28	ST02-1702	31	ST02-1929	34
ST02-1182	26	ST02-1327	27	ST02-1452	28	ST02-1710	31	ST02-1940	34
ST02-1183	26	ST02-1328	27	ST02-1453	28	ST02-1715	31	ST02-1941	34
ST02-1184	26	ST02-1329	27	ST02-1454	28	ST02-1716	31	ST02-1942	34
ST02-1185	26	ST02-1330	27	ST02-1455	28	ST02-1720	31	ST02-1943	34
ST02-1186	26	ST02-1331	27	ST02-1456	28	ST02-1721	31	ST02-1944	34
ST02-1187	26	ST02-1332	27	ST02-1457	28	ST02-1722	31	ST02-1945	34
ST02-1188	26	ST02-1333	27	ST02-1470	28	ST02-1723	31	ST02-1950	34
ST02-1189	26	ST02-1334	27	ST02-1480	28	ST02-1724	31	ST02-1951	34
ST02-1190	26	ST02-1335	27	ST02-1490	28	ST02-1730	31	ST02-1952	34
ST02-1191	26	ST02-1336	27	ST02-1491	28	ST02-1731	31	ST02-1953	34
ST02-1192	26	ST02-1337	27	ST02-1492	28	ST02-1740	32	ST02-1954	34
ST02-1193	26	ST02-1338	27	ST02-1496	28	ST02-1741	32	ST02-1955	34
ST02-1194	26	ST02-1339	27	ST02-1500	29	ST02-1742	32	ST02-1960	35
ST02-1195	26	ST02-1340	27	ST02-1501	29	ST02-1743	32	ST02-1961	35
ST02-1196	26	ST02-1341	27	ST02-1510	29	ST02-1750	32	ST02-1970	35
ST02-1197	26	ST02-1342	27	ST02-1511	29	ST02-1751	32	ST02-1971	35
ST02-1210	26	ST02-1343	27	ST02-1520	29	ST02-1760	32	ST02-1972	35
ST02-1211	26	ST02-1344	27	ST02-1521	29	ST02-1770	32	ST02-1973	35
ST02-1212	26	ST02-1345	27	ST02-1530	29	ST02-1771	32	ST02-1980	35
ST02-1220	26	ST02-1360	27	ST02-1531	29	ST02-1772	32	ST02-1981	35
ST02-1221	26	ST02-1361	27	ST02-1532	29	ST02-1773	32	ST02-1982	35
ST02-1222	26	ST02-1362	27	ST02-1533	29	ST02-1774	32	ST02-1983	35
ST02-1230	26	ST02-1363	27	ST02-1534	29	ST02-1775	32	ST02-1990	35
ST02-1231	26	ST02-1364	27	ST02-1535	29	ST02-1780	32	ST02-1991	35
ST02-1232	26	ST02-1365	27	ST02-1540	29	ST02-1781	32	ST02-1992	35
ST02-1233	26	ST02-1366	27	ST02-1545	29	ST02-1782	32	ST02-1993	35
ST02-1234	26	ST02-1367	27	ST02-1550	29	ST02-1790	32	ST02-1994	35
ST02-1235	26	ST02-1368	27	ST02-1551	29	ST02-1800	32	ST02-1995	35
ST02-1240	26	ST02-1369	27	ST02-1552	29	ST02-1810	33	ST02-1996	35
ST02-1241	26	ST02-1370	27	ST02-1553	29	ST02-1820	33	ST02-1997	35
ST02-1250	26	ST02-1371	27	ST02-1554	29	ST02-1830	33	ST02-2010	36
ST02-1255	26	ST02-1372	27	ST02-1555	29	ST02-1840	33	ST02-2011	36
ST02-1260	27	ST02-1373	27	ST02-1556	29	ST02-1850	33	ST02-2020	36
ST02-1270	27	ST02-1374	27	ST02-1557	29	ST02-1851	33	ST02-2021	36
ST02-1271	27	ST02-1375	27	ST02-1558	29	ST02-1852	33	ST02-2022	36
ST02-1272	27	ST02-1376	27	ST02-1559	29	ST02-1853	33	ST02-2023	36
ST02-1273	27	ST02-1377	27	ST02-1570	29	ST02-1870	33	ST02-2030	36

Item Code	Page	Item Code	Page	Item Code	Page	Item Code	Page	Item Code	Page
ST02-2040	36	ST02-2153	38	ST02-2290	41	ST02-2477	46	ST02-2730	51
ST02-2041	36	ST02-2154	38	ST02-2291	41	ST02-2478	46	ST02-2731	51
ST02-2042	36	ST02-2155	38	ST02-2292	41	ST02-2479	46	ST02-2732	51
ST02-2043	36	ST02-2156	38	ST02-2300	42	ST02-2490	46	ST02-2740	51
ST02-2050	37	ST02-2157	38	ST02-2310	42	ST02-2491	46	ST02-2750	51
ST02-2051	37	ST02-2158	38	ST02-2311	42	ST02-2492	46	ST02-2760	52
ST02-2052	37	ST02-2159	38	ST02-2312	42	ST02-2493	46	ST02-2770	52
ST02-2053	37	ST02-2160	38	ST02-2313	42	ST02-2494	46	ST02-2771	52
ST02-2054	37	ST02-2161	38	ST02-2320	42	ST02-2495	46	ST02-2780	52
ST02-2055	37	ST02-2162	38	ST02-2321	42	ST02-2500	47	ST02-2781	52
ST02-2056	37	ST02-2163	38	ST02-2322	42	ST02-2501	47	ST02-2790	52
ST02-2057	37	ST02-2164	38	ST02-2323	42	ST02-2502	47	ST02-2791	52
ST02-2058	37	ST02-2165	38	ST02-2330	43	ST02-2510	47	ST02-2792	52
ST02-2059	37	ST02-2170	38	ST02-2331	43	ST02-2511	47	ST02-2793	52
ST02-2070	37	ST02-2171	38	ST02-2340	43	ST02-2512	47	ST02-2794	52
ST02-2071	37	ST02-2172	38	ST02-2350	43	ST02-2520	47	ST02-2795	52
ST02-2072	37	ST02-2173	38	ST02-2360	44	ST02-2530	47	ST02-2796	52
ST02-2073	37	ST02-2174	38	ST02-2361	44	ST02-2540	47	ST02-2797	52
ST02-2074	37	ST02-2175	38	ST02-2362	44	ST02-2550	48	ST02-2798	52
ST02-2075	37	ST02-2176	38	ST02-2363	44	ST02-2551	48	ST02-2799	52
ST02-2080	37	ST02-2177	38	ST02-2364	44	ST02-2552	48	ST02-2800	52
ST02-2081	37	ST02-2178	38	ST02-2365	44	ST02-2553	48	ST02-2801	52
ST02-2082	37	ST02-2179	38	ST02-2366	44	ST02-2554	48	ST02-2810	52
ST02-2083	37	ST02-2180	38	ST02-2380	44	ST02-2555	48	ST02-2820	52
ST02-2084	37	ST02-2181	38	ST02-2381	44	ST02-2560	48	ST02-2830	52
ST02-2085	37	ST02-2182	38	ST02-2382	44	ST02-2561	48	ST02-2831	52
ST02-2090	38	ST02-2183	38	ST02-2383	44	ST02-2562	48	ST02-2840	53
ST02-2091	38	ST02-2184	38	ST02-2384	44	ST02-2563	48	ST02-2841	53
ST02-2092	38	ST02-2185	38	ST02-2385	44	ST02-2570	49	ST02-2850	53
ST02-2093	38	ST02-2190	39	ST02-2386	44	ST02-2571	49	ST02-2851	53
ST02-2094	38	ST02-2191	39	ST02-2387	44	ST02-2580	49	ST02-2860	53
ST02-2095	38	ST02-2192	39	ST02-2388	44	ST02-2590	49	ST02-2861	53
ST02-2096	38	ST02-2193	39	ST02-2389	44	ST02-2600	49	ST02-2862	53
ST02-2097	38	ST02-2194	39	ST02-2390	44	ST02-2601	49	ST02-2863	53
ST02-2098	38	ST02-2195	39	ST02-2391	44	ST02-2602	49	ST02-2864	53
ST02-2099	38	ST02-2200	39	ST02-2400	44	ST02-2603	49	ST02-2870	53
ST02-2100	38	ST02-2201	39	ST02-2410	44	ST02-2604	49	ST02-2871	53
ST02-2101	38	ST02-2202	39	ST02-2420	45	ST02-2605	49	ST02-2872	53
ST02-2102	38	ST02-2203	39	ST02-2421	45	ST02-2610	49	ST02-2873	53
ST02-2103	38	ST02-2210	39	ST02-2422	45	ST02-2611	49	ST02-2880	53
ST02-2104	38	ST02-2211	39	ST02-2423	45	ST02-2612	49	ST02-2881	53
ST02-2105	38	ST02-2212	39	ST02-2424	45	ST02-2620	49	ST02-2882	53
ST02-2106	38	ST02-2213	39	ST02-2430	45	ST02-2621	49	ST02-2883	53
ST02-2107	38	ST02-2220	39	ST02-2440	45	ST02-2630	50	ST02-2884	53
ST02-2120	38	ST02-2221	39	ST02-2441	45	ST02-2631	50	ST02-2890	54
ST02-2121	38	ST02-2222	39	ST02-2442	45	ST02-2632	50	ST02-2891	54
ST02-2122	38	ST02-2223	39	ST02-2443	45	ST02-2633	50	ST02-2892	54
ST02-2123	38	ST02-2224	39	ST02-2444	45	ST02-2640	50	ST02-2893	54
ST02-2124	38	ST02-2225	39	ST02-2450	46	ST02-2641	50	ST02-2900	54
ST02-2125	38	ST02-2230	40	ST02-2451	46	ST02-2650	50	ST02-2901	54
ST02-2126	38	ST02-2231	40	ST02-2452	46	ST02-2651	50	ST02-2902	54
ST02-2127	38	ST02-2232	40	ST02-2453	46	ST02-2652	50	ST02-2903	54
ST02-2128	38	ST02-2233	40	ST02-2454	46	ST02-2660	50	ST02-2910	54
ST02-2129	38	ST02-2240	40	ST02-2455	46	ST02-2661	50	ST02-2911	54
ST02-2130	38	ST02-2241	40	ST02-2456	46	ST02-2662	50	ST02-2912	54
ST02-2131	38	ST02-2250	40	ST02-2457	46	ST02-2663	50	ST02-2913	54
ST02-2132	38	ST02-2251	40	ST02-2458	46	ST02-2670	50	ST02-2920	54
ST02-2133	38	ST02-2252	40	ST02-2459	46	ST02-2680	50	ST02-2921	54
ST02-2134	38	ST02-2253	40	ST02-2470	46	ST02-2681	50	ST02-2922	54
ST02-2135	38	ST02-2254	40	ST02-2471	46	ST02-2682	50	ST02-2923	54
ST02-2136	38	ST02-2255	40	ST02-2472	46	ST02-2683	50	ST02-2930	55
ST02-2137	38	ST02-2256	40	ST02-2473	46	ST02-2690	51	ST02-2931	55
ST02-2150	38	ST02-2270	41	ST02-2474	46	ST02-2700	51	ST02-2932	55
ST02-2151	38	ST02-2271	41	ST02-2475	46	ST02-2710	51	ST02-2933	55
ST02-2152	38	ST02-2280	41	ST02-2476	46	ST02-2720	51	ST02-2934	55

Item Code	Page	Item Code	Page	Item Code	Page	Item Code	Page	Item Code	Page
ST02-2935	55	ST02-3220	61	ST02-3496	66	ST02-3690	71	ST02-3853	74
ST02-2936	55	ST02-3230	62	ST02-3500	67	ST02-3691	71	ST02-3854	74
ST02-2937	55	ST02-3240	62	ST02-3501	67	ST02-3692	71	ST02-3860	74
ST02-2938	55	ST02-3250	62	ST02-3502	67	ST02-3700	71	ST02-3861	74
ST02-2939	55	ST02-3251	62	ST02-3503	67	ST02-3701	71	ST02-3862	74
ST02-2940	55	ST02-3260	62	ST02-3504	67	ST02-3702	71	ST02-3870	74A
ST02-2941	55	ST02-3270	62	ST02-3505	67	ST02-3710	71	ST02-3871	74A
ST02-2942	55	ST02-3271	62	ST02-3510	67	ST02-3711	71	ST02-3872	74A
ST02-2943	55	ST02-3272	62	ST02-3511	67	ST02-3720	71	ST02-3873	74A
ST02-2950	55	ST02-3273	62	ST02-3512	67	ST02-3721	71	ST02-3874	74A
ST02-2951	55	ST02-3280	63	ST02-3513	67	ST02-3730	71	ST02-3875	74A
ST02-2952	55	ST02-3281	63	ST02-3520	67	ST02-3740	71	ST02-3880	74B
ST02-2953	55	ST02-3282	63	ST02-3521	67	ST02-3750	72	ST02-3881	74B
ST02-2960	55	ST02-3290	63	ST02-3522	67	ST02-3751	72	ST02-3882	74B
ST02-2961	55	ST02-3300	63	ST02-3523	67	ST02-3752	72	ST02-3890	75
ST02-2970	56	ST02-3310	63	ST02-3530	67	ST02-3753	72	ST02-3891	75
ST02-2971	56	ST02-3311	63	ST02-3531	67	ST02-3754	72	ST02-3892	75
ST02-2980	56	ST02-3312	63	ST02-3532	67	ST02-3755	72	ST02-3900	76
ST02-2981	56	ST02-3320	63	ST02-3533	67	ST02-3756	72	ST02-3901	76
ST02-2990	56	ST02-3321	63	ST02-3534	67	ST02-3757	72	ST02-3910	76
ST02-2991	56	ST02-3322	63	ST02-3535	67	ST02-3758	72	ST02-3911	76
ST02-3000	57	ST02-3330	64	ST02-3540	67	ST02-3759	72	ST02-3920	76
ST02-3010	57	ST02-3340	64	ST02-3541	67	ST02-3770	72	ST02-3930	76
ST02-3011	57	ST02-3350	64	ST02-3542	67	ST02-3771	72	ST02-3940	76
ST02-3012	57	ST02-3360	64	ST02-3543	67	ST02-3772	72	ST02-3941	76
ST02-3020	57	ST02-3370	64	ST02-3544	67	ST02-3773	72	ST02-3942	76
ST02-3021	57	ST02-3380	64	ST02-3545	67	ST02-3774	72	ST02-3943	76
ST02-3030	57	ST02-3390	64	ST02-3550	68	ST02-3775	72	ST02-3950	76
ST02-3040	58	ST02-3391	64	ST02-3551	68	ST02-3776	72	ST02-3951	76
ST02-3050	58	ST02-3392	64	ST02-3560	68	ST02-3777	72	ST02-3960	76
ST02-3051	58	ST02-3393	64	ST02-3561	68	ST02-3778	72	ST02-3961	76
ST02-3052	58	ST02-3394	64	ST02-3570	68	ST02-3779	72	ST02-3970	78
ST02-3053	58	ST02-3400	64	ST02-3580	68	ST02-3790	73	ST02-3971	78
ST02-3054	58	ST02-3410	65	ST02-3590	68	ST02-3791	73	ST02-3980	78
ST02-3055	58	ST02-3411	65	ST02-3591	68	ST02-3792	73	ST02-3981	78
ST02-3060	58	ST02-3412	65	ST02-3592	68	ST02-3793	73	ST02-3982	78
ST02-3061	58	ST02-3413	65	ST02-3600	69	ST02-3800	73	ST02-3983	78
ST02-3070	58	ST02-3420	65	ST02-3601	69	ST02-3801	73	ST02-3984	78
ST02-3071	58	ST02-3421	65	ST02-3602	69	ST02-3802	73	ST02-3985	78
ST02-3080	58	ST02-3422	65	ST02-3603	69	ST02-3803	73	ST02-3986	78
ST02-3081	58	ST02-3423	65	ST02-3610	69	ST02-3810	73	ST02-3987	78
ST02-3082	58	ST02-3430	65	ST02-3620	69	ST02-3811	73	ST02-3988	78
ST02-3083	58	ST02-3431	65	ST02-3621	69	ST02-3812	73	ST02-3989	78
ST02-3090	58	ST02-3432	65	ST02-3622	69	ST02-3813	73	ST02-3990	78
ST02-3091	58	ST02-3433	65	ST02-3623	69	ST02-3814	73	ST02-3991	78
ST02-3100	59	ST02-3440	65	ST02-3624	69	ST02-3815	73	ST02-4000	78
ST02-3101	59	ST02-3441	65	ST02-3625	69	ST02-3816	73	ST02-4001	78
ST02-3110	59	ST02-3442	65	ST02-3630	70	ST02-3817	73	ST02-4010	78
ST02-3111	59	ST02-3443	65	ST02-3631	70	ST02-3818	73	ST02-4020	78
ST02-3120	59	ST02-3450	65	ST02-3632	70	ST02-3819	73	ST02-4021	78
ST02-3130	59	ST02-3451	65	ST02-3640	70	ST02-3820	73	ST02-4022	78
ST02-3140	60	ST02-3452	65	ST02-3641	70	ST02-3821	73	ST02-4030	79
ST02-3150	60	ST02-3453	65	ST02-3642	70	ST02-3830	74	ST02-4040	79
ST02-3151	60	ST02-3454	65	ST02-3650	70	ST02-3831	74	ST02-4050	79
ST02-3152	60	ST02-3455	65	ST02-3651	70	ST02-3832	74	ST02-4051	79
ST02-3153	60	ST02-3460	66	ST02-3652	70	ST02-3833	74	ST02-4052	79
ST02-3160	60	ST02-3461	66	ST02-3660	70	ST02-3834	74	ST02-4053	79
ST02-3161	60	ST02-3462	66	ST02-3661	70	ST02-3840	74	ST02-4060	79
ST02-3170	60	ST02-3463	66	ST02-3662	70	ST02-3841	74	ST02-4061	79
ST02-3171	60	ST02-3470	66	ST02-3670	70	ST02-3842	74	ST02-4062	79
ST02-3180	61	ST02-3471	66	ST02-3671	70	ST02-3843	74	ST02-4063	79
ST02-3181	61	ST02-3480	66	ST02-3672	70	ST02-3844	74	ST02-4064	79
ST02-3190	61	ST02-3490	66	ST02-3680	71	ST02-3850	74	ST02-4065	79
ST02-3200	61	ST02-3491	66	ST02-3681	71	ST02-3851	74	ST02-4066	79
ST02-3210	61	ST02-3495	66	ST02-3682	71	ST02-3852	74	ST02-4067	79

Item Code	Page	Item Code	Page	Item Code	Page	Item Code	Page	Item Code	Page
ST02-4068	79	ST02-4189	79	ST02-4386	83	ST02-4660	88	ST02-4890	92
ST02-4069	79	ST02-4200	79	ST02-4400	83	ST02-4670	88	ST02-4900	92
ST02-4070	79	ST02-4201	79	ST02-4401	83	ST02-4671	88	ST02-4901	92
ST02-4071	79	ST02-4202	79	ST02-4402	83	ST02-4680	88	ST02-4910	92
ST02-4080	79	ST02-4203	79	ST02-4403	83	ST02-4681	88	ST02-4911	92
ST02-4081	79	ST02-4204	79	ST02-4404	83	ST02-4690	88	ST02-4920	92
ST02-4082	79	ST02-4205	79	ST02-4405	83	ST02-4700	88	ST02-4921	92
ST02-4083	79	ST02-4206	79	ST02-4406	83	ST02-4710	89	ST02-4930	92
ST02-4084	79	ST02-4207	79	ST02-4420	83	ST02-4720	89	ST02-4940	92
ST02-4085	79	ST02-4208	79	ST02-4421	83	ST02-4730	89	ST02-4950	92
ST02-4086	79	ST02-4209	79	ST02-4422	83	ST02-4731	89	ST02-4951	92
ST02-4087	79	ST02-4220	79	ST02-4423	83	ST02-4732	89	ST02-4960	93
ST02-4088	79	ST02-4221	79	ST02-4424	83	ST02-4740	89	ST02-4961	93
ST02-4089	79	ST02-4222	79	ST02-4426	83	ST02-4741	89	ST02-4962	93
ST02-4100	79	ST02-4223	79	ST02-4430	84	ST02-4742	89	ST02-4963	93
ST02-4101	79	ST02-4224	79	ST02-4440	84	ST02-4743	89	ST02-4970	93
ST02-4102	79	ST02-4225	79	ST02-4450	84	ST02-4744	89	ST02-4971	93
ST02-4103	79	ST02-4226	79	ST02-4451	84	ST02-4745	89	ST02-4972	93
ST02-4104	79	ST02-4227	79	ST02-4452	84	ST02-4750	89	ST02-4973	93
ST02-4105	79	ST02-4228	79	ST02-4453	84	ST02-4760	90	ST02-4974	93
ST02-4106	79	ST02-4229	79	ST02-4460	84	ST02-4761	90	ST02-4975	93
ST02-4107	79	ST02-4240	79	ST02-4461	84	ST02-4770	90	ST02-4976	93
ST02-4108	79	ST02-4241	79	ST02-4462	84	ST02-4771	90	ST02-4977	93
ST02-4109	79	ST02-4242	79	ST02-4470	84	ST02-4780	90	ST02-4978	93
ST02-4120	79	ST02-4243	79	ST02-4480	85	ST02-4781	90	ST02-4979	93
ST02-4121	79	ST02-4244	79	ST02-4490	85	ST02-4790	90	ST02-4990	93
ST02-4122	79	ST02-4245	79	ST02-4500	85	ST02-4791	90	ST02-5000	93
ST02-4123	79	ST02-4246	79	ST02-4501	85	ST02-4792	90	ST02-5001	93
ST02-4124	79	ST02-4247	79	ST02-4510	85	ST02-4793	90	ST02-5002	93
ST02-4125	79	ST02-4248	79	ST02-4520	85	ST02-4800	90	ST02-5003	93
ST02-4126	79	ST02-4249	79	ST02-4530	86	ST02-4801	90	ST02-5004	93
ST02-4127	79	ST02-4260	80	ST02-4531	86	ST02-4802	90	ST02-5005	93
ST02-4128	79	ST02-4261	80	ST02-4540	86	ST02-4803	90	ST02-5010	93
ST02-4129	79	ST02-4265	80	ST02-4550	86	ST02-4804	90	ST02-5011	93
ST02-4140	79	ST02-4266	80	ST02-4551	86	ST02-4810	90	ST02-5012	93
ST02-4141	79	ST02-4270	80	ST02-4552	86	ST02-4811	90	ST02-5013	93
ST02-4142	79	ST02-4271	80	ST02-4553	86	ST02-4812	90	ST02-5014	93
ST02-4143	79	ST02-4272	80	ST02-4560	86	ST02-4813	90	ST02-5015	93
ST02-4144	79	ST02-4273	80	ST02-4561	86	ST02-4814	90	ST02-5020	94
ST02-4145	79	ST02-4274	80	ST02-4562	86	ST02-4815	90	ST02-5021	94
ST02-4146	79	ST02-4280	80	ST02-4563	86	ST02-4816	90	ST02-5022	94
ST02-4147	79	ST02-4281	80	ST02-4570	86	ST02-4817	90	ST02-5023	94
ST02-4148	79	ST02-4290	80	ST02-4571	86	ST02-4818	90	ST02-5024	94
ST02-4149	79	ST02-4300	80	ST02-4572	86	ST02-4819	90	ST02-5025	94
ST02-4160	79	ST02-4301	80	ST02-4573	86	ST02-4830	91	ST02-5030	94
ST02-4161	79	ST02-4310	81	ST02-4580	86	ST02-4831	91	ST02-5031	94
ST02-4162	79	ST02-4311	81	ST02-4581	86	ST02-4832	91	ST02-5032	94
ST02-4163	79	ST02-4312	81	ST02-4590	87	ST02-4840	91	ST02-5033	94
ST02-4164	79	ST02-4313	81	ST02-4595	87	ST02-4841	91	ST02-5034	94
ST02-4165	79	ST02-4314	81	ST02-4600	87	ST02-4842	91	ST02-5035	94
ST02-4166	79	ST02-4320	81	ST02-4610	87	ST02-4843	91	ST02-5040	94
ST02-4167	79	ST02-4330	81	ST02-4611	87	ST02-4844	91	ST02-5041	94
ST02-4168	79	ST02-4340	81	ST02-4612	87	ST02-4845	91	ST02-5042	94
ST02-4169	79	ST02-4341	81	ST02-4613	87	ST02-4846	91	ST02-5043	94
ST02-4170	79	ST02-4350	81	ST02-4614	87	ST02-4847	91	ST02-5050	94
ST02-4171	79	ST02-4360	82	ST02-4615	87	ST02-4848	91	ST02-5051	94
ST02-4180	79	ST02-4370	82	ST02-4616	87	ST02-4849	91	ST02-5052	94
ST02-4181	79	ST02-4371	82	ST02-4617	87	ST02-4860	91	ST02-5053	94
ST02-4182	79	ST02-4372	82	ST02-4618	87	ST02-4861	91	ST02-5054	94
ST02-4183	79	ST02-4380	83	ST02-4619	87	ST02-4862	91	ST02-5055	94
ST02-4184	79	ST02-4381	83	ST02-4620	87	ST02-4863	91	ST02-5060	95
ST02-4185	79	ST02-4382	83	ST02-4621	87	ST02-4870	91	ST02-5061	95
ST02-4186	79	ST02-4383	83	ST02-4630	87	ST02-4871	91	ST02-5062	95
ST02-4187	79	ST02-4384	83	ST02-4640	87	ST02-4880	91	ST02-5063	95
ST02-4188	79	ST02-4385	83	ST02-4650	88	ST02-4881	91	ST02-5070	95

Item Code	Page	Item Code	Page	Item Code	Page	Item Code	Page	Item Code	Page
ST02-5071	95	ST03-0111	100	ST03-0540	108	ST03-0860	112	ST03-1051	114
ST02-5072	95	ST03-0112	100	ST03-0541	108	ST03-0861	112	ST03-1052	114
ST02-5073	95	ST03-0120	101	ST03-0542	108	ST03-0862	112	ST03-1053	114
ST02-5074	95	ST03-0121	101	ST03-0543	108	ST03-0863	112	ST03-1054	114
ST02-5080	95	ST03-0130	101	ST03-0550	108	ST03-0864	112	ST03-1055	114
ST02-5081	95	ST03-0131	101	ST03-0560	108	ST03-0865	112	ST03-1056	114
ST02-5082	95	ST03-0140	101	ST03-0570	108	ST03-0866	112	ST03-1060	114
ST02-5083	95	ST03-0141	101	ST03-0571	108	ST03-0867	112	ST03-1061	114
ST02-5084	95	ST03-0142	101	ST03-0580	109	ST03-0868	112	ST03-1070	114
ST02-5085	95	ST03-0150	101	ST03-0590	109	ST03-0869	112	ST03-1071	114
ST02-5086	95	ST03-0151	101	ST03-0600	109	ST03-0870	112	ST03-1072	114
ST02-5087	95	ST03-0160	101	ST03-0610	109	ST03-0871	112	ST03-1073	114
ST02-5088	95	ST03-0170	101	ST03-0620	109	ST03-0872	112	ST03-1074	114
ST02-5089	95	ST03-0180	102	ST03-0630	109	ST03-0873	112	ST03-1080	114
ST02-5090	95	ST03-0190	102	ST03-0640	109	ST03-0880	112	ST03-1081	114
ST02-5091	95	ST03-0200	102	ST03-0650	110	ST03-0881	112	ST03-1090	114
ST02-5092	95	ST03-0210	103	ST03-0660	110	ST03-0882	112	ST03-1091	114
ST02-5093	95	ST03-0220	103	ST03-0670	110	ST03-0883	112	ST03-1092	114
ST02-5094	95	ST03-0230	103	ST03-0680	110	ST03-0884	112	ST03-1093	114
ST02-5100	95	ST03-0240	103	ST03-0690	110	ST03-0885	112	ST03-1100	115
ST02-5101	95	ST03-0250	104	ST03-0700	110	ST03-0886	112	ST03-1110	115
ST02-5110	95	ST03-0260	104	ST03-0710	111	ST03-0887	112	ST03-1120	115
ST02-5111	95	ST03-0261	104	ST03-0720	111	ST03-0900	112	ST03-1130	115
ST02-5112	95	ST03-0270	104	ST03-0730	111	ST03-0901	112	ST03-1131	115
ST02-5113	95	ST03-0271	104	ST03-0740	111	ST03-0902	112	ST03-1140	115
ST02-5114	95	ST03-0280	104	ST03-0750	111	ST03-0903	112	ST03-1150	115
ST02-5120	96	ST03-0281	104	ST03-0760	111	ST03-0904	112	ST03-1160	116
ST02-5123	96	ST03-0290	104	ST03-0770	111	ST03-0905	112	ST03-1161	116
ST02-5124	96	ST03-0300	105	ST03-0771	111	ST03-0906	112	ST03-1170	116
ST02-5125	96	ST03-0301	105	ST03-0780	111	ST03-0907	112	ST03-1171	116
ST02-5128	96	ST03-0310	105	ST03-0781	111	ST03-0908	112	ST03-1180	116
ST02-5130	96	ST03-0320	105	ST03-0890	111	ST03-0909	112	ST03-1181	116
ST02-5131	96	ST03-0330	105	ST03-0891	111	ST03-0910	112	ST03-1182	116
ST02-5132	96	ST03-0331	105	ST03-0892	111	ST03-0920	112	ST03-1190	116
ST02-5133	96	ST03-0340	105	ST03-0800	111	ST03-0921	112	ST03-1200	116
ST02-5134	96	ST03-0350	106	ST03-0801	111	ST03-0922	112	ST03-1210	117
ST02-5140	96	ST03-0355	106	ST03-0802	111	ST03-0923	112	ST03-1211	117
ST02-5141	96	ST03-0360	106	ST03-0803	111	ST03-0930	112	ST03-1212	117
ST02-5142	96	ST03-0365	106	ST03-0810	111	ST03-0940	113	ST03-1213	117
ST02-5143	96	ST03-0366	106	ST03-0811	111	ST03-0950	113	ST03-1214	117
ST02-5144	96	ST03-0367	106	ST03-0812	111	ST03-0960	113	ST03-1215	117
ST02-5150	97	ST03-0368	106	ST03-0820	111	ST03-0970	113	ST03-1216	117
ST02-5151	97	ST03-0370	106	ST03-0821	111	ST03-0980	113	ST03-1217	117
ST02-5160	97	ST03-0371	106	ST03-0822	111	ST03-0990	113	ST03-1218	117
ST02-5161	97	ST03-0372	106	ST03-0823	111	ST03-1000	114	ST03-1219	117
ST03-0001	98	ST03-0375	106	ST03-0824	111	ST03-1001	114	ST03-1230	117
ST03-0010	98	ST03-0380	106	ST03-0825	111	ST03-1002	114	ST03-1231	117
ST03-0020	98	ST03-0390	106	ST03-0830	112	ST03-1003	114	ST03-1232	117
ST03-0030	98	ST03-0400	106	ST03-0831	112	ST03-1004	114	ST03-1233	117
ST03-0040	99	ST03-0401	106	ST03-0832	112	ST03-1010	114	ST03-1234	117
ST03-0041	99	ST03-0402	106	ST03-0833	112	ST03-1011	114	ST03-1235	117
ST03-0042	99	ST03-0410	106	ST03-0834	112	ST03-1012	114	ST03-1236	117
ST03-0043	99	ST03-0420	107	ST03-0835	112	ST03-1013	114	ST03-1237	117
ST03-0044	99	ST03-0430	107	ST03-0840	112	ST03-1014	114	ST03-1238	117
ST03-0045	99	ST03-0440	107	ST03-0841	112	ST03-1015	114	ST03-1239	117
ST03-0050	99	ST03-0450	107	ST03-0842	112	ST03-1016	114	ST03-1250	117
ST03-0051	99	ST03-0460	107	ST03-0843	112	ST03-1017	114	ST03-1251	117
ST03-0060	100	ST03-0470	108	ST03-0844	112	ST03-1018	114	ST03-1252	117
ST03-0065	100	ST03-0480	108	ST03-0845	112	ST03-1030	114	ST03-1253	117
ST03-0070	100	ST03-0490	108	ST03-0846	112	ST03-1031	114	ST03-1254	117
ST03-0080	100	ST03-0500	108	ST03-0847	112	ST03-1040	114	ST03-1255	117
ST03-0090	100	ST03-0510	108	ST03-0848	112	ST03-1041	114	ST03-1256	117
ST03-0091	100	ST03-0520	108	ST03-0849	112	ST03-1042	114	ST03-1257	117
ST03-0100	100	ST03-0521	108	ST03-0850	112	ST03-1043	114	ST03-1258	117
ST03-0110	100	ST03-0530	108	ST03-0851	112	ST03-1050	114	ST03-1259	117





Item Code	Page	Item Code	Page	Item Code	Page	Item Code	Page	Item Code	Page
ST03-2190	132	ST03-2570	139	ST03-2842	145	ST03-3066	150	ST03-3351	156
ST03-2200	132	ST03-2580	139	ST03-2850	145	ST03-3067	150	ST03-3360	156
ST03-2210	132	ST03-2590	139	ST03-2851	145	ST03-3068	150	ST03-3370	157
ST03-2220	133	ST03-2600	140	ST03-2852	145	ST03-3069	150	ST03-3380	157
ST03-2221	133	ST03-2610	140	ST03-2860	145	ST03-3080	150	ST03-3390	157
ST03-2230	133	ST03-2620	140	ST03-2861	145	ST03-3081	150	ST03-3391	157
ST03-2240	133	ST03-2630	140	ST03-2862	145	ST03-3082	150	ST03-3400	157
ST03-2250	133	ST03-2640	140	ST03-2870	145	ST03-3083	150	ST03-3401	157
ST03-2260	133	ST03-2650	141	ST03-2880	146	ST03-3084	150	ST03-3410	157
ST03-2270	133	ST03-2660	141	ST03-2881	146	ST03-3085	150	ST03-3420	157
ST03-2280	133	ST03-2670	141	ST03-2882	146	ST03-3086	150	ST03-3430	158
ST03-2281	133	ST03-2671	141	ST03-2883	146	ST03-3087	150	ST03-3440	158
ST03-2282	133	ST03-2680	141	ST03-2884	146	ST03-3088	150	ST03-3450	158
ST03-2290	134	ST03-2681	141	ST03-2885	146	ST03-3089	150	ST03-3451	158
ST03-2291	134	ST03-2690	142	ST03-2890	146	ST03-3100	151	ST03-3460	158
ST03-2292	134	ST03-2691	142	ST03-2900	147	ST03-3101	151	ST03-3461	158
ST03-2300	134	ST03-2692	142	ST03-2901	147	ST03-3110	151	ST03-3470	158
ST03-2310	134	ST03-2693	142	ST03-2902	147	ST03-3120	151	ST03-3471	158
ST03-2320	134	ST03-2700	142	ST03-2910	147	ST03-3121	151	ST03-3480	158
ST03-2330	134	ST03-2701	142	ST03-2911	147	ST03-3122	151	ST03-3485	159
ST03-2340	134	ST03-2702	142	ST03-2912	147	ST03-3130	151	ST03-3490	159
ST03-2341	134	ST03-2703	142	ST03-2913	147	ST03-3140	152	ST03-3491	159
ST03-2350	135	ST03-2704	142	ST03-2920	147	ST03-3141	152	ST03-3492	159
ST03-2351	135	ST03-2710	142	ST03-2930	147	ST03-3142	152	ST03-3500	159
ST03-2360	135	ST03-2711	142	ST03-2940	148	ST03-3143	152	ST03-3501	159
ST03-2370	135	ST03-2712	142	ST03-2950	148	ST03-3144	152	ST03-3502	159
ST03-2371	135	ST03-2713	142	ST03-2960	148	ST03-3145	152	ST03-3510	160
ST03-2372	135	ST03-2720	142	ST03-2970	148	ST03-3146	152	ST03-3511	160
ST03-2373	135	ST03-2721	142	ST03-2971	148	ST03-3147	152	ST03-3512	160
ST03-2374	135	ST03-2722	142	ST03-2972	148	ST03-3148	152	ST03-3513	160
ST03-2380	135	ST03-2723	142	ST03-2980	149	ST03-3149	152	ST03-3514	160
ST03-2381	135	ST03-2730	142	ST03-2981	149	ST03-3160	152	ST03-3515	160
ST03-2390	135	ST03-2731	142	ST03-2982	149	ST03-3170	152	ST03-3516	160
ST03-2400	135	ST03-2732	142	ST03-2983	149	ST03-3171	152	ST03-3517	160
ST03-2410	136	ST03-2733	142	ST03-2990	149	ST03-3172	152	ST03-3518	160
ST03-2420	136	ST03-2740	143	ST03-2991	149	ST03-3180	152	ST03-3530	160
ST03-2421	136	ST03-2741	143	ST03-2992	149	ST03-3190	153	ST03-3531	160
ST03-2430	136	ST03-2742	143	ST03-2993	149	ST03-3191	153	ST03-3532	160
ST03-2431	136	ST03-2750	143	ST03-3000	149	ST03-3192	153	ST03-3533	160
ST03-2432	136	ST03-2751	143	ST03-3001	149	ST03-3193	153	ST03-3534	160
ST03-2440	136	ST03-2760	143	ST03-3002	149	ST03-3200	153	ST03-3535	160
ST03-2441	136	ST03-2761	143	ST03-3010	149	ST03-3201	153	ST03-3536	160
ST03-2442	136	ST03-2770	144	ST03-3011	149	ST03-3202	153	ST03-3537	160
ST03-2443	136	ST03-2771	144	ST03-3012	149	ST03-3203	153	ST03-3538	160
ST03-2450	136	ST03-2772	144	ST03-3020	150	ST03-3210	153	ST03-3550	160
ST03-2451	136	ST03-2773	144	ST03-3021	150	ST03-3211	153	ST03-3551	160
ST03-2452	136	ST03-2774	144	ST03-3022	150	ST03-3220	153	ST03-3552	160
ST03-2460	136	ST03-2775	144	ST03-3023	150	ST03-3230	154	ST03-3553	160
ST03-2461	136	ST03-2776	144	ST03-3024	150	ST03-3231	154	ST03-3554	160
ST03-2470	137	ST03-2777	144	ST03-3025	150	ST03-3240	154	ST03-3555	160
ST03-2480	137	ST03-2790	144	ST03-3030	150	ST03-3241	154	ST03-3556	160
ST03-2490	137	ST03-2800	144	ST03-3031	150	ST03-3250	154	ST03-3557	160
ST03-2500	137	ST03-2801	144	ST03-3040	150	ST03-3251	154	ST03-3558	160
ST03-2510	137	ST03-2802	144	ST03-3050	150	ST03-3260	154	ST03-3570	160
ST03-2520	138	ST03-2810	145	ST03-3051	150	ST03-3261	154	ST03-3571	160
ST03-2530	138	ST03-2811	145	ST03-3052	150	ST03-3270	155	ST03-3572	160
ST03-2531	138	ST03-2812	145	ST03-3053	150	ST03-3280	155	ST03-3573	160
ST03-2540	138	ST03-2820	145	ST03-3054	150	ST03-3290	155	ST03-3574	160
ST03-2541	138	ST03-2821	145	ST03-3055	150	ST03-3291	155	ST03-3575	160
ST03-2542	138	ST03-2822	145	ST03-3060	150	ST03-3300	155	ST03-3576	160
ST03-2543	138	ST03-2830	145	ST03-3061	150	ST03-3310	156	ST03-3577	160
ST03-2550	138	ST03-2831	145	ST03-3062	150	ST03-3320	156	ST03-3578	160
ST03-2551	138	ST03-2832	145	ST03-3063	150	ST03-3330	156	ST03-3590	160
ST03-2552	138	ST03-2840	145	ST03-3064	150	ST03-3340	156	ST03-3591	160
ST03-2560	138	ST03-2841	145	ST03-3065	150	ST03-3350	156	ST03-3592	160

Item Code	Page	Item Code	Page	Item Code	Page	Item Code	Page	Item Code	Page
ST03-3593	160	ST03-3774	161	ST03-4150	172	ST03-4354	175	ST03-4570	179
ST03-3594	160	ST03-3780	161	ST03-4151	172	ST03-4355	175	ST03-4571	179
ST03-3595	160	ST03-3781	161	ST03-4160	172	ST03-4356	175	ST03-4580	179
ST03-3596	160	ST03-3782	161	ST03-4161	172	ST03-4370	176	ST03-4590	179
ST03-3597	160	ST03-3790	161	ST03-4170	172	ST03-4380	176	ST03-4600	179
ST03-3598	160	ST03-3800	161	ST03-4180	173	ST03-4390	176	ST03-4610	179
ST03-3610	160	ST03-3801	161	ST03-4181	173	ST03-4391	176	ST03-4620	179
ST03-3611	160	ST03-3802	161	ST03-4182	173	ST03-4392	176	ST03-4630	179
ST03-3612	160	ST03-3803	161	ST03-4183	173	ST03-4393	176	ST03-4640	179
ST03-3620	160	ST03-3810	162	ST03-4191	173	ST03-4394	176	ST03-4650	180
ST03-3621	160	ST03-3820	162	ST03-4192	173	ST03-4395	176	ST03-4660	180
ST03-3622	160	ST03-3830	162	ST03-4193	173	ST03-4396	176	ST03-4670	180
ST03-3623	160	ST03-3840	162	ST03-4194	173	ST03-4410	176	ST03-4680	180
ST03-3624	160	ST03-3850	162	ST03-4195	173	ST03-4420	176	ST03-4690	180
ST03-3625	160	ST03-3860	162	ST03-4200	173	ST03-4430	177	ST03-4700	180
ST03-3626	160	ST03-3870	163	ST03-4201	173	ST03-4431	177	ST03-4710	180
ST03-3627	160	ST03-3880	163	ST03-4202	173	ST03-4432	177	ST03-4711	180
ST03-3628	160	ST03-3890	163	ST03-4203	173	ST03-4433	177	ST03-4712	180
ST03-3640	160	ST03-3891	163	ST03-4204	173	ST03-4434	177	ST03-4720	181
ST03-3641	160	ST03-3892	163	ST03-4210	173	ST03-4435	177	ST03-4730	181
ST03-3642	160	ST03-3900	164	ST03-4211	173	ST03-4436	177	ST03-4740	181
ST03-3643	160	ST03-3901	164	ST03-4212	173	ST03-4450	177	ST03-4745	181
ST03-3644	160	ST03-3902	164	ST03-4213	173	ST03-4451	177	ST03-4750	181
ST03-3645	160	ST03-3903	164	ST03-4214	173	ST03-4452	177	ST03-4751	181
ST03-3646	160	ST03-3910	164	ST03-4215	173	ST03-4453	177	ST03-4760	181
ST03-3647	160	ST03-3920	165	ST03-4220	173	ST03-4454	177	ST03-4761	181
ST03-3648	160	ST03-3930	166	ST03-4221	173	ST03-4455	177	ST03-4770	181
ST03-3660	160	ST03-3940	166	ST03-4222	173	ST03-4456	177	ST03-4775	181
ST03-3661	160	ST03-3950	167	ST03-4225	173	ST03-4470	177	ST03-4780	182
ST03-3662	160	ST03-3951	167	ST03-4226	173	ST03-4471	177	ST03-4790	182
ST03-3663	160	ST03-3952	167	ST03-4227	173	ST03-4472	177	ST03-4800	182
ST03-3664	160	ST03-3960	167	ST03-4230	173	ST03-4473	177	ST03-4801	182
ST03-3665	160	ST03-3961	167	ST03-4231	173	ST03-4474	177	ST03-4810	182
ST03-3666	160	ST03-3962	167	ST03-4232	173	ST03-4475	177	ST03-4820	182
ST03-3667	160	ST03-3970	168	ST03-4240	173	ST03-4476	177	ST03-4830	182
ST03-3668	160	ST03-3980	168	ST03-4241	173	ST03-4490	177	ST03-4840	182
ST03-3680	160	ST03-3990	168	ST03-4242	173	ST03-4491	177	ST03-4850	183
ST03-3681	160	ST03-3991	168	ST03-4250	173	ST03-4492	177	ST03-4860	183
ST03-3682	160	ST03-3992	168	ST03-4251	173	ST03-4493	177	ST03-4870	183
ST03-3683	160	ST03-3993	168	ST03-4252	173	ST03-4494	177	ST03-4880	183
ST03-3684	160	ST03-3994	168	ST03-4260	174	ST03-4495	177	ST03-4890	183
ST03-3685	160	ST03-4000	168	ST03-4261	174	ST03-4496	177	ST03-4900	183
ST03-3686	160	ST03-4001	168	ST03-4270	174	ST03-4497	177	ST03-4910	183
ST03-3687	160	ST03-4002	168	ST03-4280	174	ST03-4510	177	ST03-4920	183
ST03-3688	160	ST03-4010	169	ST03-4290	174	ST03-4511	177	ST03-4930	184
ST03-3700	160	ST03-4011	169	ST03-4291	174	ST03-4520	178	ST03-4940	184
ST03-3701	160	ST03-4012	169	ST03-4300	174	ST03-4521	178	ST03-4950	184
ST03-3702	160	ST03-4020	169	ST03-4301	174	ST03-4530	178	ST03-4951	184
ST03-3703	160	ST03-4030	169	ST03-4302	174	ST03-4531	178	ST03-4952	184
ST03-3704	160	ST03-4040	169	ST03-4310	175	ST03-4532	178	ST03-4960	184
ST03-3705	160	ST03-4050	170	ST03-4311	175	ST03-4533	178	ST03-4970	184
ST03-3706	160	ST03-4051	170	ST03-4320	175	ST03-4534	178	ST03-4980	184
ST03-3707	160	ST03-4060	170	ST03-4321	175	ST03-4540	178	ST03-4990	184
ST03-3708	160	ST03-4070	170	ST03-4330	175	ST03-4541	178	ST03-5000	184
ST03-3720	160	ST03-4071	170	ST03-4331	175	ST03-4542	178	ST03-5010	184
ST03-3730	160	ST03-4080	170	ST03-4332	175	ST03-4543	178	ST03-5020	185
ST03-3731	160	ST03-4090	170	ST03-4340	175	ST03-4544	178	ST03-5021	185
ST03-3732	160	ST03-4100	170	ST03-4341	175	ST03-4550	178	ST03-5030	185
ST03-3740	161	ST03-4101	170	ST03-4342	175	ST03-4551	178	ST03-5040	185
ST03-3750	161	ST03-4102	170	ST03-4343	175	ST03-4552	178	ST03-5041	185
ST03-3760	161	ST03-4110	170	ST03-4344	175	ST03-4553	178	ST03-5050	185
ST03-3770	161	ST03-4120	171	ST03-4350	175	ST03-4560	178	ST03-5060	185
ST03-3771	161	ST03-4130	171	ST03-4351	175	ST03-4561	178	ST03-5070	186
ST03-3772	161	ST03-4131	171	ST03-4352	175	ST03-4562	178	ST03-5071	186
ST03-3773	161	ST03-4140	171	ST03-4353	175	ST03-4563	178	ST03-5072	186

Item Code	Page	Item Code	Page	Item Code	Page	Item Code	Page	Item Code	Page
ST03-5073	186	ST03-5430	191	ST03-5651	194	ST03-5822	196	ST03-6102	197
ST03-5074	186	ST03-5431	191	ST03-5652	194	ST03-5823	196	ST03-6110	197
ST03-5075	186	ST03-5432	191	ST03-5653	194	ST03-5830	196	ST03-6111	197
ST03-5076	186	ST03-5440	191	ST03-5654	194	ST03-5831	196	ST03-6112	197
ST03-5077	186	ST03-5441	191	ST03-5655	194	ST03-5832	196	ST03-6120	197
ST03-5090	186	ST03-5442	191	ST03-5656	194	ST03-5833	196	ST03-6121	197
ST03-5091	186	ST03-5443	191	ST03-5657	194	ST03-5840	196	ST03-6122	197
ST03-5100	186	ST03-5444	191	ST03-5670	194	ST03-5841	196	ST03-6130	197
ST03-5110	186	ST03-5450	191	ST03-5671	194	ST03-5842	196	ST03-6131	197
ST03-5111	186	ST03-5460	192	ST03-5672	194	ST03-5843	196	ST03-6132	197
ST03-5120	186	ST03-5470	192	ST03-5673	194	ST03-5850	196	ST03-6140	197
ST03-5121	186	ST03-5480	192	ST03-5674	194	ST03-5851	196	ST03-6141	197
ST03-5130	186	ST03-5490	192	ST03-5675	194	ST03-5852	196	ST03-6142	197
ST03-5131	186	ST03-5500	192	ST03-5676	194	ST03-5853	196	ST03-6150	198
ST03-5140	187	ST03-5510	192	ST03-5677	194	ST03-5860	196	ST03-6151	198
ST03-5141	187	ST03-5520	192	ST03-5690	194	ST03-5870	196	ST03-6152	198
ST03-5150	187	ST03-5530	193	ST03-5691	194	ST03-5880	196	ST03-6160	198
ST03-5151	187	ST03-5531	193	ST03-5692	194	ST03-5890	196	ST03-6161	198
ST03-5160	187	ST03-5532	193	ST03-5693	194	ST03-5900	196	ST03-6162	198
ST03-5161	187	ST03-5533	193	ST03-5694	194	ST03-5910	196	ST03-6170	198
ST03-5170	187	ST03-5534	193	ST03-5695	194	ST03-5920	196	ST03-6171	198
ST03-5171	187	ST03-5535	193	ST03-5696	194	ST03-5930	196	ST03-6172	198
ST03-5180	188	ST03-5536	193	ST03-5697	194	ST03-5940	196	ST03-6180	198
ST03-5181	188	ST03-5537	193	ST03-5710	194	ST03-5950	196	ST03-6181	198
ST03-5182	188	ST03-5550	193	ST03-5711	194	ST03-5970	197	ST03-6182	198
ST03-5190	188	ST03-5551	193	ST03-5712	194	ST03-5971	197	ST03-6190	198
ST03-5191	188	ST03-5552	193	ST03-5713	194	ST03-5972	197	ST03-6191	198
ST03-5192	188	ST03-5553	193	ST03-5714	194	ST03-5980	197	ST03-6192	198
ST03-5193	188	ST03-5554	193	ST03-5715	194	ST03-5981	197	ST03-6200	198
ST03-5200	188	ST03-5555	193	ST03-5716	194	ST03-5982	197	ST03-6201	198
ST03-5210	188	ST03-5556	193	ST03-5717	194	ST03-5990	197	ST03-6202	198
ST03-5220	188	ST03-5557	193	ST03-5730	194	ST03-5991	197	ST03-6210	198
ST03-5221	188	ST03-5570	193	ST03-5731	194	ST03-5992	197	ST03-6211	198
ST03-5222	188	ST03-5571	193	ST03-5732	194	ST03-6000	197	ST03-6212	198
ST03-5230	189	ST03-5572	193	ST03-5733	194	ST03-6001	197	ST03-6220	198
ST03-5240	189	ST03-5573	193	ST03-5734	194	ST03-6002	197	ST03-6221	198
ST03-5250	189	ST03-5574	193	ST03-5735	194	ST03-6010	197	ST03-6222	198
ST03-5251	189	ST03-5575	193	ST03-5736	194	ST03-6011	197	ST03-6230	198
ST03-5255	189	ST03-5576	193	ST03-5737	194	ST03-6012	197	ST03-6231	198
ST03-5256	189	ST03-5577	193	ST03-5750	195	ST03-6020	197	ST03-6232	198
ST03-5260	189	ST03-5590	193	ST03-5751	195	ST03-6021	197	ST03-6240	199
ST03-5270	189	ST03-5591	193	ST03-5760	195	ST03-6022	197	ST03-6241	199
ST03-5280	189	ST03-5592	193	ST03-5761	195	ST03-6030	197	ST03-6242	199
ST03-5290	190	ST03-5593	193	ST03-5770	195	ST03-6031	197	ST03-6250	199
ST03-5300	190	ST03-5594	193	ST03-5771	195	ST03-6032	197	ST03-6251	199
ST03-5310	190	ST03-5595	193	ST03-5772	195	ST03-6040	197	ST03-6252	199
ST03-5320	190	ST03-5596	193	ST03-5773	195	ST03-6041	197	ST03-6260	199
ST03-5330	190	ST03-5597	193	ST03-5774	195	ST03-6042	197	ST03-6261	199
ST03-5340	190	ST03-5610	193	ST03-5775	195	ST03-6050	197	ST03-6262	199
ST03-5350	190	ST03-5611	193	ST03-5780	195	ST03-6051	197	ST03-6270	199
ST03-5360	190	ST03-5612	193	ST03-5781	195	ST03-6052	197	ST03-6271	199
ST03-5370	190	ST03-5613	193	ST03-5790	196	ST03-6060	197	ST03-6272	199
ST03-5380	190	ST03-5614	193	ST03-5791	196	ST03-6061	197	ST03-6280	199
ST03-5390	190	ST03-5615	193	ST03-5792	196	ST03-6062	197	ST03-6281	199
ST03-5391	190	ST03-5616	193	ST03-5793	196	ST03-6070	197	ST03-6282	199
ST03-5400	190	ST03-5617	193	ST03-5800	196	ST03-6071	197	ST03-6290	199
ST03-5410	191	ST03-5630	193	ST03-5801	196	ST03-6072	197	ST03-6291	199
ST03-5411	191	ST03-5631	193	ST03-5802	196	ST03-6080	197	ST03-6292	199
ST03-5412	191	ST03-5632	193	ST03-5803	196	ST03-6081	197	ST03-6300	199
ST03-5413	191	ST03-5633	193	ST03-5810	196	ST03-6082	197	ST03-6301	199
ST03-5420	191	ST03-5634	193	ST03-5811	196	ST03-6090	197	ST03-6302	199
ST03-5421	191	ST03-5635	193	ST03-5812	196	ST03-6091	197	ST03-6303	199
ST03-5422	191	ST03-5636	193	ST03-5813	196	ST03-6092	197	ST03-6304	199
ST03-5423	191	ST03-5637	193	ST03-5820	196	ST03-6100	197	ST03-6310	200
ST03-5424	191	ST03-5650	194	ST03-5821	196	ST03-6101	197	ST03-6320	200

Item Code	Page	Item Code	Page	Item Code	Page	Item Code	Page	Item Code	Page
ST03-6330	200	ST04-0320	208	ST04-0920	214	ST04-1530	219	ST04-2080	226
ST03-6340	200	ST04-0325	208	ST04-0930	214	ST04-1535	219	ST04-2090	226
ST03-6350	201	ST04-0330	208	ST04-0940	214	ST04-1540	219	ST04-2100	226
ST03-6360	201	ST04-0335	208	ST04-0950	214	ST04-1545	219A	ST04-2110	227
ST04-0001	202	ST04-0340	208	ST04-0960	214	ST04-1550	219A	ST04-2120	227
ST04-0002	202	ST04-0345	208	ST04-0970	214	ST04-1555	219A	ST04-2130	227
ST04-0003	202	ST04-0350	209	ST04-0980	214	ST04-1560	219A	ST04-2140	227
ST04-0010	202	ST04-0360	209	ST04-0990	214	ST04-1565	219A	ST04-2150	227
ST04-0011	202	ST04-0361	209	ST04-1000	215	ST04-1570	219A	ST04-2160	227
ST04-0012	202	ST04-0370	209	ST04-1010	215	ST04-1575	219A	ST04-2170	227
ST04-0013	202	ST04-0380	209	ST04-1020	215	ST04-1580	219B	ST04-2180	227
ST04-0014	202	ST04-0390	209	ST04-1030	215	ST04-1585	219B	ST04-2190	227
ST04-0015	202	ST04-0395	209	ST04-1040	215	ST04-1590	219B	ST04-2200	227
ST04-0020	202	ST04-0400	210	ST04-1050	215	ST04-1591	219B	ST04-2210	227
ST04-0021	202	ST04-0410	210	ST04-1060	215	ST04-1592	219B	ST04-2220	227
ST04-0022	202	ST04-0420	210	ST04-1070	215	ST04-1595	219B	ST04-2230	227
ST04-0023	202	ST04-0430	210	ST04-1080	215	ST04-1600	219B	ST04-2240	227
ST04-0024	202	ST04-0440	210	ST04-1090	215	ST04-1610	220	ST04-2250	228
ST04-0030	202	ST04-0450	210	ST04-1100	215	ST04-1615	220	ST04-2260	228
ST04-0031	202	ST04-0460	210	ST04-1110	215	ST04-1620	220	ST04-2270	228
ST04-0032	202	ST04-0470	210	ST04-1120	216	ST04-1630	220	ST04-2280	228
ST04-0033	202	ST04-0480	210	ST04-1130	216	ST04-1640	220	ST04-2290	228
ST04-0040	202	ST04-0490	210	ST04-1140	216	ST04-1650	220	ST04-2300	228
ST04-0041	202	ST04-0500	210	ST04-1150	216	ST04-1660	220	ST04-2310	228
ST04-0042	202	ST04-0510	210	ST04-1160	216	ST04-1670	220	ST04-2320	228
ST04-0043	202	ST04-0520	211	ST04-1170	216	ST04-1680	220	ST04-2330	228
ST04-0044	202	ST04-0530	211	ST04-1180	216	ST04-1690	220	ST04-2340	228
ST04-0050	202	ST04-0540	211	ST04-1190	216	ST04-1700	220	ST04-2350	228
ST04-0051	202	ST04-0550	211	ST04-1200	216	ST04-1710	220	ST04-2360	228
ST04-0052	202	ST04-0560	211	ST04-1210	216	ST04-1720	221	ST04-2370	229
ST04-0053	202	ST04-0570	211	ST04-1220	216	ST04-1730	221	ST04-2380	229
ST04-0060	203	ST04-0580	211	ST04-1230	216	ST04-1740	221	ST04-2390	229
ST04-0070	203	ST04-0590	211	ST04-1240	217	ST04-1750	221	ST04-2400	229
ST04-0080	203	ST04-0600	211	ST04-1250	217	ST04-1760	221	ST04-2410	229
ST04-0090	203	ST04-0610	211	ST04-1260	217	ST04-1770	221	ST04-2420	229
ST04-0100	203	ST04-0620	211	ST04-1270	217	ST04-1780	221	ST04-2430	229
ST04-0110	204	ST04-0630	211	ST04-1280	217	ST04-1790	222	ST04-2440	229
ST04-0120	204	ST04-0640	212	ST04-1290	217	ST04-1800	222	ST04-2450	229
ST04-0121	204	ST04-0650	212	ST04-1300	217	ST04-1810	222	ST04-2460	229
ST04-0130	204	ST04-0660	212	ST04-1310	217	ST04-1820	222	ST04-2470	229
ST04-0131	204	ST04-0670	212	ST04-1320	217	ST04-1830	223	ST04-2480	229
ST04-0140	204	ST04-0680	212	ST04-1330	217	ST04-1840	223	ST04-2490	230
ST04-0141	204	ST04-0690	212	ST04-1340	217	ST04-1850	223	ST04-2491	230
ST04-0150	204	ST04-0700	212	ST04-1350	217	ST04-1860	223	ST04-2492	230
ST04-0151	204	ST04-0710	212	ST04-1360	218	ST04-1870	223	ST04-2500	230
ST04-0160	205	ST04-0720	212	ST04-1370	218	ST04-1880	223	ST04-2501	230
ST04-0161	205	ST04-0730	212	ST04-1380	218	ST04-1890	224	ST04-2502	230
ST04-0170	205	ST04-0740	212	ST04-1390	218	ST04-1900	224	ST04-2510	230
ST04-0180	205	ST04-0750	212	ST04-1400	218	ST04-1910	224	ST04-2511	230
ST04-0182	205	ST04-0760	213	ST04-1410	218	ST04-1920	224	ST04-2512	230
ST04-0190	205	ST04-0770	213	ST04-1420	218	ST04-1930	224	ST04-2530	231
ST04-0192	205	ST04-0780	213	ST04-1430	218	ST04-1940	224	ST04-2531	231
ST04-0200	205	ST04-0790	213	ST04-1440	218	ST04-1950	225	ST04-2632	231
ST04-0202	205	ST04-0800	213	ST04-1450	218	ST04-1960	225	ST04-2540	231
ST04-0210	206	ST04-0810	213	ST04-1460	218	ST04-1970	225	ST04-2541	231
ST04-0220	206	ST04-0820	213	ST04-1470	218	ST04-1980	225	ST04-2542	231
ST04-0230	206	ST04-0830	213	ST04-1480	219	ST04-1990	225	ST04-2550	231
ST04-0240	206	ST04-0840	213	ST04-1485	219	ST04-2000	225	ST04-2551	231
ST04-0250	206	ST04-0850	213	ST04-1490	219	ST04-2010	225	ST04-2552	231
ST04-0260	207	ST04-0860	213	ST04-1495	219	ST04-2020	225	ST04-2570	232
ST04-0270	207	ST04-0870	213	ST04-1500	219	ST04-2030	226	ST04-2571	232
ST04-0280	207	ST04-0880	214	ST04-1510	219	ST04-2040	226	ST04-2572	232
ST04-0290	207	ST04-0890	214	ST04-1515	219	ST04-2050	226	ST04-2580	232
ST04-0300	207	ST04-0900	214	ST04-1520	219	ST04-2060	226	ST04-2581	232
ST04-0310	207	ST04-0910	214	ST04-1525	219	ST04-2070	226	ST04-2582	232

Item Code	Page	Item Code	Page	Item Code	Page	Item Code	Page	Item Code	Page
ST04-2590	233	ST04-2892	236	ST04-3330	240	ST04-3831	245	ST04-4110	247
ST04-2591	232	ST04-2900	236	ST04-3331	240	ST04-3832	245	ST04-4120	247
ST04-2592	232	ST04-2901	236	ST04-3332	240	ST04-3833	245	ST04-4130	247
ST04-2610	232	ST04-2902	236	ST04-3333	240	ST04-3834	245	ST04-4140	248
ST04-2611	233	ST04-2910	236	ST04-3334	240	ST04-3840	245	ST04-4150	248
ST04-2612	233	ST04-2911	236	ST04-3335	240	ST04-3841	245	ST04-4160	248
ST04-2620	233	ST04-2912	236	ST04-3360	241	ST04-3842	245	ST04-4170	248
ST04-2621	233	ST04-2920	236	ST04-3361	241	ST04-3843	245	ST04-4180	248
ST04-2622	233	ST04-2921	236	ST04-3370	241	ST04-3844	245	ST04-4190	248
ST04-2630	233	ST04-2922	236	ST04-3371	241	ST04-3850	245	ST04-4200	248
ST04-2631	233	ST04-2930	236	ST04-3380	241	ST04-3851	245	ST04-4210	248
ST04-2632	233	ST04-2931	236	ST04-3381	241	ST04-3852	245	ST04-4220	248
ST04-2640	234	ST04-2932	236	ST04-3390	241	ST04-3853	245	ST04-4230	248
ST04-2650	234	ST04-2940	237	ST04-3391	241	ST04-3854	245	ST04-4240	248
ST04-2660	234	ST04-2950	237	ST04-3400	241	ST04-3860	245	ST04-4250	248
ST04-2670	234	ST04-2960	237	ST04-3401	241	ST04-3861	245	ST04-4260	249
ST04-2680	234	ST04-2970	237	ST04-3410	241	ST04-3862	245	ST04-4261	249
ST04-2690	234	ST04-2980	237	ST04-3411	241	ST04-3863	245	ST04-4262	249
ST04-2700	235	ST04-2990	237	ST04-3420	241	ST04-3864	245	ST04-4270	249
ST04-2710	235	ST04-3000	237	ST04-3421	241	ST04-3870	245	ST04-4271	249
ST04-2720	235	ST04-3001	237	ST04-3430	241	ST04-3971	245	ST04-4272	249
ST04-2730	235	ST04-3010	237	ST04-3431	241	ST04-3972	245	ST04-4280	249
ST04-2740	235	ST04-3011	237	ST04-3440	241	ST04-3973	245	ST04-4281	249
ST04-2750	235	ST04-3020	237	ST04-3441	241	ST04-3974	245	ST04-4282	249
ST04-2760	235	ST04-3021	237	ST04-3450	241	ST04-3880	245	ST04-4290	249
ST04-2761	235	ST04-3030	237	ST04-3451	241	ST04-3981	245	ST04-4291	249
ST04-2762	235	ST04-3031	237	ST04-3460	241	ST04-3982	245	ST04-4300	249
ST04-2770	235	ST04-3040	237	ST04-3461	241	ST04-3983	245	ST04-4301	249
ST04-2771	235	ST04-3041	237	ST04-3470	241	ST04-3984	245	ST04-4310	249
ST04-2772	235	ST04-3050	237	ST04-3471	241	ST04-3890	245	ST04-4311	249
ST04-2780	235	ST04-3051	237	ST04-3480	242	ST04-3891	245	ST04-4320	249
ST04-2781	235	ST04-3060	238	ST04-3490	242	ST04-3892	245	ST04-4330	249
ST04-2782	235	ST04-3070	238	ST04-3500	242	ST04-3893	245	ST04-4340	249
ST04-2790	235	ST04-3080	238	ST04-3510	242	ST04-3894	245	ST04-4350	250
ST04-2791	235	ST04-3090	238	ST04-3520	242	ST04-3900	245	ST04-4351	250
ST04-2792	235	ST04-3100	238	ST04-3530	242	ST04-3901	245	ST04-4352	250
ST04-2800	235	ST04-3110	238	ST04-3540	242	ST04-3902	245	ST04-4360	250
ST04-2801	235	ST04-3111	238	ST04-3541	242	ST04-3903	245	ST04-4361	250
ST04-2802	235	ST04-3112	238	ST04-3542	242	ST04-3904	245	ST04-4362	250
ST04-2810	235	ST04-3120	238	ST04-3543	242	ST04-3910	245	ST04-4370	250
ST04-2811	235	ST04-3130	238	ST04-3544	242	ST04-3911	245	ST04-4371	250
ST04-2812	235	ST04-3140	238	ST04-3545	242	ST04-3912	245	ST04-4372	250
ST04-2820	236	ST04-3150	238	ST04-3560	243	ST04-3913	245	ST04-4380	250
ST04-2821	236	ST04-3160	238	ST04-3561	243	ST04-3914	245	ST04-4381	250
ST04-2822	236	ST04-3170	238	ST04-3562	243	ST04-3920	246	ST04-4382	250
ST04-2830	236	ST04-3171	238	ST04-3563	243	ST04-3925	246	ST04-4383	250
ST04-2831	236	ST04-3172	238	ST04-3564	243	ST04-3930	246	ST04-4384	250
ST04-2832	236	ST04-3180	239	ST04-3565	243	ST04-3935	246	ST04-4390	250
ST04-2840	236	ST04-3190	239	ST04-3750	244	ST04-3940	246	ST04-4391	250
ST04-2841	236	ST04-3200	239	ST04-3760	244	ST04-3950	246	ST04-4392	250
ST04-2842	236	ST04-3210	239	ST04-3770	244	ST04-3960	246	ST04-4393	250
ST04-2850	236	ST04-3220	239	ST04-3780	244	ST04-3970	246	ST04-4394	250
ST04-2851	236	ST04-3230	239	ST04-3790	244	ST04-3980	246	ST04-4400	250
ST04-2852	236	ST04-3240	239	ST04-3800	244	ST04-3990	246	ST04-4401	250
ST04-2860	236	ST04-3250	239	ST04-3810	245	ST04-4000	246	ST04-4402	250
ST04-2861	236	ST04-3260	239	ST04-3811	245	ST04-4010	246	ST04-4403	250
ST04-2862	236	ST04-3270	239	ST04-3812	245	ST04-4020	247	ST04-4404	250
ST04-2870	236	ST04-3280	239	ST04-3813	245	ST04-4030	247	ST04-4410	251
ST04-2871	236	ST04-3290	239	ST04-3814	245	ST04-4040	247	ST04-4420	251
ST04-2872	236	ST04-3300	240	ST04-3820	245	ST04-4050	247	ST04-4430	251
ST04-2880	236	ST04-3301	240	ST04-3821	245	ST04-4060	247	ST04-4440	252
ST04-2881	236	ST04-3302	240	ST04-3822	245	ST04-4070	247	ST04-4450	252
ST04-2882	236	ST04-3303	240	ST04-3823	245	ST04-4080	247	ST04-4451	252
ST04-2890	236	ST04-3304	240	ST04-3824	245	ST04-4090	247	ST04-4452	252
ST04-2891	236	ST04-3305	240	ST04-3830	245	ST04-4100	247	ST04-4453	252

Item Code	Page	Item Code	Page	Item Code	Page	Item Code	Page	Item Code	Page
ST04-4454	252	ST04-4660	255	ST04-5170	261	ST05-0121	269	ST05-0610	277
ST04-4460	252	ST04-4661	255	ST04-5180	262	ST05-0122	269	ST05-0620	278
ST04-4461	252	ST04-4662	255	ST04-5181	262	ST05-0130	269	ST05-0630	278
ST04-4462	252	ST04-4670	255	ST04-5182	262	ST05-0131	269	ST05-0640	278
ST04-4463	252	ST04-4671	255	ST04-5190	262	ST05-0132	269	ST05-0650	278
ST04-4464	252	ST04-4672	255	ST04-5191	262	ST05-0140	270	ST05-0660	278
ST04-4470	252	ST04-4673	255	ST04-5192	262	ST05-0150	270	ST05-0670	279
ST04-4471	252	ST04-4680	255	ST04-5193	262	ST05-0160	270	ST05-0671	279
ST04-4472	252	ST04-4681	255	ST04-5194	262	ST05-0170	270	ST05-0680	279
ST04-4473	252	ST04-4682	255	ST04-5195	262	ST05-0180	270	ST05-0681	279
ST04-4474	252	ST04-4683	255	ST04-5196	262	ST05-0190	270	ST05-0690	279
ST04-4480	252	ST04-4684	255	ST04-5197	262	ST05-0200	271	ST05-0691	279
ST04-4481	252	ST04-4690	256	ST04-5198	262	ST05-0210	271	ST05-0700	279
ST04-4482	252	ST04-4700	256	ST04-5199	262	ST05-0220	271	ST05-0710	279
ST04-4483	252	ST04-4710	256	ST04-5200	262	ST05-0230	271	ST05-0711	279
ST04-4484	252	ST04-4720	256	ST04-5201	262	ST05-0240	271	ST05-0720	279
ST04-4490	252	ST04-4730	256	ST04-5202	262	ST05-0250	271	ST05-0721	279
ST04-4491	252	ST04-4740	256	ST04-5203	262	ST05-0260	272	ST05-0730	280
ST04-4492	252	ST04-4741	256	ST04-5210	262	ST05-0270	272	ST05-0740	280
ST04-4493	252	ST04-4750	257	ST04-5211	262	ST05-0280	272	ST05-0750	280
ST04-4494	252	ST04-4760	257	ST04-5220	262	ST05-0281	272	ST05-0760	280
ST04-4500	252	ST04-4770	257	ST04-5221	262	ST05-0290	272	ST05-0770	280
ST04-4501	252	ST04-4780	257	ST04-5222	262	ST05-0291	272	ST05-0780	280
ST04-4502	252	ST04-4790	257	ST04-5230	262	ST05-0300	272	ST05-0790	280
ST04-4503	252	ST04-4800	257	ST04-5231	262	ST05-0301	272	ST05-0800	280
ST04-4504	252	ST04-4810	258	ST04-5232	262	ST05-0303	272	ST05-0810	281
ST04-4510	252	ST04-4820	258	ST04-5233	262	ST05-0310	273	ST05-0820	281
ST04-4511	252	ST04-4830	258	ST04-5234	262	ST05-0320	273	ST05-0830	281
ST04-4512	252	ST04-4840	258	ST04-5240	263	ST05-0330	273	ST05-0840	282
ST04-4513	252	ST04-4850	258	ST04-5250	263	ST05-0331	273	ST05-0850	282
ST04-4514	252	ST04-4860	258	ST04-5260	263	ST05-0332	273	ST05-0860	282
ST04-4520	252	ST04-4870	258	ST04-5270	263	ST05-0333	273	ST05-0861	282
ST04-4521	252	ST04-4880	258	ST04-5280	263	ST05-0334	273	ST05-0870	282
ST04-4522	252	ST04-4890	258	ST04-5281	263	ST05-0335	273	ST05-0880	282
ST04-4523	252	ST04-4900	258	ST04-5282	263	ST05-0340	273	ST05-0890	283
ST04-4524	252	ST04-4910	258	ST04-5283	263	ST05-0350	273	ST05-0900	283
ST04-4530	253	ST04-4920	258	ST04-5290	263	ST05-0360	273	ST05-0910	283
ST04-4531	253	ST04-4930	259	ST04-5291	263	ST05-0370	274	ST05-0920	283
ST04-4532	253	ST04-4940	259	ST04-5292	263	ST05-0380	274	ST05-0930	283
ST04-4533	253	ST04-4950	259	ST04-5300	263	ST05-0381	274	ST05-0940	283
ST04-4540	253	ST04-4960	259	ST04-5301	263	ST05-0390	274	ST05-0950	284
ST04-4541	253	ST04-4970	259	ST04-5302	263	ST05-0400	274	ST05-0960	284
ST04-4542	253	ST04-4980	259	ST04-5303	263	ST05-0410	274	ST05-0970	284
ST04-4545	253	ST04-4990	259	ST04-5310	263	ST05-0420	274	ST05-0980	284
ST04-4550	254	ST04-5000	259	ST04-5311	263	ST05-0430	274	ST05-0990	284
ST04-4560	254	ST04-5010	259	ST04-5312	263	ST05-0450	275	ST05-1000	284
ST04-4570	254	ST04-5020	259	ST04-5313	263	ST05-0460	275	ST05-1010	284
ST04-4580	254	ST04-5030	259	ST05-0001	264	ST05-0470	275	ST05-1020	284
ST04-4590	254	ST04-5040	259	ST05-0002	264	ST05-0480	275	ST05-1030	284
ST04-4595	254	ST04-5050	260	ST05-0005	264	ST05-0490	275	ST05-1040	285
ST04-4600	254	ST04-5060	260	ST05-0006	264	ST05-0500	275	ST05-1050	285
ST04-4610	254	ST04-5061	260	ST05-0010	265	ST05-0501	275	ST05-1060	285
ST04-4611	254	ST04-5070	260	ST05-0011	265	ST05-0510	276	ST05-1070	285
ST04-4620	255	ST04-5071	260	ST05-0020	265	ST05-0520	276	ST05-1080	285
ST04-4621	255	ST04-5080	260	ST05-0030	266	ST05-0530	276	ST05-1090	285
ST04-4622	255	ST04-5081	260	ST05-0040	266	ST05-0540	276	ST05-1100	285
ST04-4623	255	ST04-5090	260	ST05-0050	266	ST05-0550	276	ST05-1110	285
ST04-4630	255	ST04-5091	260	ST05-0060	267	ST05-0560	277	ST05-1120	286
ST04-4631	255	ST04-5100	260	ST05-0061	267	ST05-0561	277	ST05-1130	286
ST04-4640	255	ST04-5110	261	ST05-0070	268	ST05-0570	277	ST05-1140	286
ST04-4641	255	ST04-5120	261	ST05-0080	268	ST05-0571	277	ST05-1150	286
ST04-4642	255	ST04-5130	261	ST05-0090	268	ST05-0580	277	ST05-1160	286
ST04-4650	255	ST04-5140	261	ST05-0100	268	ST05-0581	277	ST05-1170	286
ST04-4651	255	ST04-5150	261	ST05-0110	269	ST05-0590	277	ST05-1180	286
ST04-4652	255	ST04-5160	261	ST05-0120	269	ST05-0600	277	ST05-1190	287

Item Code	Page	Item Code	Page	Item Code	Page	Item Code	Page	Item Code	Page
ST05-1200	287	ST05-1590	295	ST05-2180	304	ST05-2700	313	ST05-3100	320
ST05-1210	287	ST05-1600	295	ST05-2190	304	ST05-2710	313	ST05-3110	320
ST05-1220	287	ST05-1610	295	ST05-2200	304	ST05-2720	314	ST05-3120	320
ST05-1221	287	ST05-1620	295	ST05-2210	304	ST05-2730	314	ST05-3130	320
ST05-1230	287	ST05-1621	295	ST05-2220	304	ST05-2740	314	ST05-3140	320
ST05-1240	288	ST05-1630	296	ST05-2230	304	ST05-2741	314	ST05-3150	320
ST05-1250	288	ST05-1640	296	ST05-2240	305	ST05-2750	314	ST06-0001	321
ST05-1251	288	ST05-1650	296	ST05-2250	305	ST05-2760	315	ST06-0010	321
ST05-1260	288	ST05-1660	296	ST05-2251	305	ST05-2761	315	ST06-0020	321
ST05-1261	288	ST05-1670	296	ST05-2260	305	ST05-2770	315	ST06-0030	321
ST05-1270	288	ST05-1680	297	ST05-2270	305	ST05-2771	315	ST06-0040	321
ST05-1271	288	ST05-1681	297	ST05-2280	305	ST05-2772	315	ST06-0050	321
ST05-1280	288	ST05-1682	297	ST05-2290	306	ST05-2773	315	ST06-0060	321
ST05-1290	289	ST05-1690	297	ST05-2300	306	ST05-2780	315	ST06-0070	322
ST05-1291	289	ST05-1691	297	ST05-2310	306	ST05-2781	315	ST06-0080	322
ST05-1300	289	ST05-1692	297	ST05-2320	306	ST05-2782	315	ST06-0090	322
ST05-1310	289	ST05-1700	297	ST05-2330	306	ST05-2783	315	ST06-0100	322
ST05-1320	290	ST05-1710	298	ST05-2340	306	ST05-2790	315	ST06-0110	322
ST05-1321	290	ST05-1720	298	ST05-2350	307	ST05-2791	315	ST06-0120	323
ST05-1330	290	ST05-1730	298	ST05-2360	307	ST05-2792	315	ST06-0130	323
ST05-1340	290	ST05-1731	298	ST05-2370	307	ST05-2793	315	ST06-0140	323
ST05-1350	290	ST05-1740	298	ST05-2380	307	ST05-2800	315	ST06-0150	323
ST05-1351	290	ST05-1750	298	ST05-2390	307	ST05-2801	315	ST06-0160	323
ST05-1360	290	ST05-1760	298	ST05-2400	308	ST05-2802	315	ST06-0170	323
ST05-1361	290	ST05-1770	298	ST05-2410	309	ST05-2803	315	ST06-0180	324
ST05-1362	290	ST05-1780	299	ST05-2420	309	ST05-2810	315	ST06-0190	324
ST05-1370	291	ST05-1790	299	ST05-2430	309	ST05-2820	316	ST06-0200	324
ST05-1380	291	ST05-1800	299	ST05-2440	309	ST05-2821	316	ST06-0210	324
ST05-1381	291	ST05-1810	299	ST05-2450	309	ST05-2822	316	ST06-0211	324
ST05-1382	291	ST05-1820	299	ST05-2451	309	ST05-2823	316	ST06-0220	324
ST05-1390	291	ST05-1830	299	ST05-2460	309	ST05-2824	316	ST06-0230	324
ST05-1391	291	ST05-1840	299	ST05-2470	309	ST05-2830	316	ST06-0231	324
ST05-1392	291	ST05-1850	300	ST05-2480	309	ST05-2840	316	ST06-0240	324
ST05-1400	291	ST05-1860	300	ST05-2490	309	ST05-2850	316	ST06-0250	325
ST05-1401	291	ST05-1870	300	ST05-2500	310	ST05-2860	316	ST06-0260	325
ST05-1402	291	ST05-1880	300	ST05-2510	310	ST05-2870	316	ST06-0270	325
ST05-1410	291	ST05-1890	300	ST05-2520	310	ST05-2880	316	ST06-0271	325
ST05-1420	291	ST05-1900	300	ST05-2530	310	ST05-2890	316	ST06-0272	325
ST05-1430	292	ST05-1910	300	ST05-2540	310	ST05-2891	316	ST06-0273	325
ST05-1431	292	ST05-1920	301	ST05-2550	311	ST05-2900	317	ST06-0280	325
ST05-1440	292	ST05-1930	301	ST05-2560	311	ST05-2910	317	ST06-0290	325
ST05-1441	292	ST05-1940	301	ST05-2570	311	ST05-2920	317	ST06-0300	325
ST05-1450	292	ST05-1950	301	ST05-2571	311	ST05-2930	317	ST06-0310	325
ST05-1460	292	ST05-1960	301	ST05-2580	311	ST05-2940	317	ST06-0320	325
ST05-1461	292	ST05-1970	301	ST05-2581	311	ST05-2941	317	ST06-0330	326
ST05-1470	292	ST05-1980	301	ST05-2582	311	ST05-2942	317	ST06-0340	326
ST05-1480	293	ST05-1990	301	ST05-2583	311	ST05-2950	317	ST06-0350	326
ST05-1590	293	ST05-2000	301	ST05-2584	311	ST05-2960	317	ST06-0360	326
ST05-1500	293	ST05-2010	302	ST05-2585	311	ST05-2970	317	ST06-0370	326
ST05-1510	293	ST05-2020	302	ST05-2590	311	ST05-2980	318	ST06-0371	326
ST05-1511	293	ST05-2030	302	ST05-2600	312	ST05-2990	318	ST06-0372	326
ST05-1512	293	ST05-2040	302	ST05-2610	312	ST05-3000	318	ST06-0380	327
ST05-1520	293	ST05-2050	302	ST05-2620	312	ST05-3010	318	ST06-0390	327
ST05-1521	293	ST05-2060	302	ST05-2621	312	ST05-3020	318	ST06-0400	327
ST05-1530	293	ST05-2070	302	ST05-2630	312	ST05-3030	318	ST06-0410	327
ST05-1531	293	ST05-2080	302	ST05-2640	312	ST05-3040	318	ST06-0420	327
ST05-1532	293	ST05-2090	303	ST05-2641	312	ST05-3050	319	ST06-0430	328
ST05-1540	294	ST05-2100	303	ST05-2650	312	ST05-3051	319	ST06-0440	328
ST05-1550	294	ST05-2110	303	ST05-2660	313	ST05-3060	319	ST06-0450	328
ST05-1551	294	ST05-2120	303	ST05-2670	313	ST05-3061	319	ST06-0460	328
ST05-1560	294	ST05-2130	303	ST05-2671	313	ST05-3062	319	ST06-0470	328
ST05-1561	294	ST05-2140	303	ST05-2672	313	ST05-3063	319	ST06-0471	328
ST05-1570	294	ST05-2150	303	ST05-2673	313	ST05-3070	319	ST06-0480	328
ST05-1571	294	ST05-2160	303	ST05-2680	313	ST05-3080	319	ST06-0490	328
ST05-1580	295	ST05-2170	303	ST05-2690	313	ST05-3090	319	ST06-0500	328

Item Code	Page	Item Code	Page	Item Code	Page	Item Code	Page	Item Code	Page
ST06-0510	329	ST06-1050	336	ST06-1420	340	ST06-1940	348	ST06-2440	355
ST06-0520	329	ST06-1060	336	ST06-1430	340	ST06-1950	349	ST06-2450	355
ST06-0521	329	ST06-1061	336	ST06-1440	340	ST06-1960	349	ST06-2460	355
ST06-0530	329	ST06-1062	336	ST06-1450	341	ST06-1970	349	ST06-2470	355
ST06-0531	329	ST06-1070	336	ST06-1460	341	ST06-1980	349	ST06-2480	356
ST06-0540	329	ST06-1071	336	ST06-1470	341	ST06-1981	349	ST06-2490	356
ST06-0550	329	ST06-1072	336	ST06-1471	341	ST06-1990	349	ST06-2500	356
ST06-0560	329	ST06-1080	336	ST06-1472	341	ST06-1991	349	ST06-2510	356
ST06-0570	329	ST06-1090	336	ST06-1473	341	ST06-2000	349	ST06-2520	356
ST06-0580	329	ST06-1100	336	ST06-1480	341	ST06-2010	349	ST06-2530	356
ST06-0590	329	ST06-1101	336	ST06-1490	341	ST06-2011	349	ST06-2540	356
ST06-0600	329	ST06-1102	336	ST06-1500	341	ST06-2020	350	ST06-2550	356
ST06-0601	329	ST06-1103	336	ST06-1501	341	ST06-2021	350	ST06-2560	357
ST06-0610	330	ST06-1104	336	ST06-1502	341	ST06-2022	350	ST06-2570	357
ST06-0620	330	ST06-1105	336	ST06-1503	341	ST06-2023	350	ST06-2580	357
ST06-0630	330	ST06-1106	336	ST06-1510	341	ST06-2024	350	ST06-2590	357
ST06-0640	330	ST06-1107	336	ST06-1520	341	ST06-2040	350	ST06-2600	358
ST06-0650	330	ST06-1108	336	ST06-1530	342	ST06-2041	350	ST06-2610	358
ST06-0655	330	ST06-1120	337	ST06-1531	342	ST06-2042	350	ST06-2620	358
ST06-0660	330	ST06-1130	337	ST06-1532	342	ST06-2043	350	ST06-2630	358
ST06-0661	330	ST06-1140	337	ST06-1540	342	ST06-2044	350	ST06-2640	358
ST06-0662	330	ST06-1141	337	ST06-1541	342	ST06-2060	350	ST06-2650	358
ST06-0663	330	ST06-1142	337	ST06-1542	342	ST06-2070	350	ST06-2660	358
ST06-0664	330	ST06-1143	337	ST06-1550	342	ST06-2080	350	ST07-0001	359
ST06-0670	330	ST06-1144	337	ST06-1560	342	ST06-2090	350	ST07-0005	359
ST06-0680	330	ST06-1150	337	ST06-1570	342	ST06-2100	350	ST07-0010	359
ST06-0690	330	ST06-1151	337	ST06-1580	342	ST06-2150	351	ST07-0020	360
ST06-0700	330	ST06-1152	337	ST06-1590	342	ST06-2160	351	ST07-0030	360
ST06-0710	331	ST06-1153	337	ST06-1591	342	ST06-2161	351	ST07-0040	361
ST06-0720	331	ST06-1154	337	ST06-1600	342	ST06-2170	351	ST07-0041	361
ST06-0730	331	ST06-1155	337	ST06-1601	342	ST06-2171	351	ST07-0050	361
ST06-0740	331	ST06-1160	337	ST06-1610	343	ST06-2180	351	ST07-0060	361
ST06-0750	331	ST06-1161	337	ST06-1620	343	ST06-2190	351	ST07-0061	361
ST06-0760	331	ST06-1162	337	ST06-1630	343	ST06-2200	352	ST07-0070	362
ST06-0770	331	ST06-1163	337	ST06-1640	343	ST06-2210	352	ST07-0080	362
ST06-0780	331	ST06-1170	337	ST06-1650	343	ST06-2211	352	ST07-0090	362
ST06-0790	331	ST06-1171	337	ST06-1660	343	ST06-2212	352	ST07-0100	362
ST06-0800	332	ST06-1172	337	ST06-1670	343	ST06-2220	352	ST07-0110	362
ST06-0810	332	ST06-1180	338	ST06-1680	344	ST06-2230	352	ST07-0120	363
ST06-0820	332	ST06-1190	338	ST06-1690	344	ST06-2240	352	ST07-0130	363
ST06-0830	332	ST06-1200	338	ST06-1700	344	ST06-2250	352	ST07-0140	363
ST06-0840	332	ST06-1210	338	ST06-1710	344	ST06-2260	353	ST07-0150	363
ST06-0850	332	ST06-1220	338	ST06-1720	344	ST06-2270	353	ST07-0160	364
ST06-0860	332	ST06-1230	338	ST06-1730	344	ST06-2280	353	ST07-0170	364
ST06-0870	333	ST06-1240	338	ST06-1740	344	ST06-2290	353	ST07-0180	364
ST06-0880	333	ST06-1250	339	ST06-1750	345	ST06-2300	353	ST07-0190	365
ST06-0890	333	ST06-1260	339	ST06-1760	345	ST06-2301	353	ST07-0200	365
ST06-0900	333	ST06-1270	339	ST06-1770	345	ST06-2302	353	ST07-0210	365
ST06-0910	333	ST06-1280	339	ST06-1780	345	ST06-2310	353	ST07-0220	366
ST06-0920	334	ST06-1290	339	ST06-1790	345	ST06-2311	353	ST07-0221	366
ST06-0930	334	ST06-1300	339	ST06-1800	346	ST06-2312	353	ST07-0222	366
ST06-0940	334	ST06-1301	339	ST06-1801	346	ST06-2320	353	ST07-0230	366
ST06-0950	334	ST06-1310	339	ST06-1810	346	ST06-2330	353	ST07-0231	366
ST06-0960	334	ST06-1320	340	ST06-1820	346	ST06-2340	354	ST07-0232	366
ST06-0970	334	ST06-1330	340	ST06-1830	346	ST06-2341	354	ST07-0240	366
ST06-0980	334	ST06-1331	340	ST06-1840	346	ST06-2350	354	ST07-0241	366
ST06-0990	334	ST06-1340	340	ST06-1850	346	ST06-2360	354	ST07-0250	366
ST06-0995	334	ST06-1350	340	ST06-1860	346	ST06-2370	354	ST07-0260	366
ST06-1000	335	ST06-1360	340	ST06-1870	347	ST06-2380	354	ST07-0261	366
ST06-1010	335	ST06-1370	340	ST06-1880	347	ST06-2381	354	ST07-0262	366
ST06-1020	336	ST06-1380	340	ST06-1890	347	ST06-2390	354	ST07-0270	367
ST06-1030	336	ST06-1381	340	ST06-1900	347	ST06-2400	354	ST07-0280	367
ST06-1040	336	ST06-1390	340	ST06-1910	347	ST06-2410	354	ST07-0290	367
ST06-1041	336	ST06-1400	340	ST06-1920	348	ST06-2420	355	ST07-0300	367
ST06-1042	336	ST06-1410	340	ST06-1930	348	ST06-2430	355	ST07-0310	367



Item Code	Page	Item Code	Page	Item Code	Page	Item Code	Page	Item Code	Page
ST07-0320	367	ST07-0434	368	ST07-0565	370	ST07-0700	372	ST07-0890	376
ST07-0330	367	ST07-0435	368	ST07-0566	370	ST07-0701	372		
ST07-0340	367	ST07-0436	368	ST07-0580	370	ST07-0703	372		
ST07-0350	367	ST07-0437	368	ST07-0581	370	ST07-0704	372		
ST07-0360	368	ST07-0438	368	ST07-0582	370	ST07-0706	372		
ST07-0361	368	ST07-0439	368	ST07-0583	370	ST07-0707	372		
ST07-0362	368	ST07-0440	368	ST07-0584	370	ST07-0709	372		
ST07-0363	368	ST07-0441	368	ST07-0585	370	ST07-0710	372		
ST07-0364	368	ST07-0442	368	ST07-0586	370	ST07-0712	372		
ST07-0365	368	ST07-0443	368	ST07-0587	370	ST07-0713	372		
ST07-0366	368	ST07-0450	369	ST07-0588	370	ST07-0715	372		
ST07-0367	368	ST07-0451	369	ST07-0589	370	ST07-0716	372		
ST07-0368	368	ST07-0452	369	ST07-0590	370	ST07-0718	372		
ST07-0369	368	ST07-0453	369	ST07-0591	370	ST07-0719	372		
ST07-0370	368	ST07-0454	369	ST07-0592	370	ST07-0721	372		
ST07-0371	368	ST07-0455	369	ST07-0593	370	ST07-0722	372		
ST07-0372	368	ST07-0456	369	ST07-0600	370	ST07-0730	373		
ST07-0373	368	ST07-0457	369	ST07-0601	370	ST07-0731	373		
ST07-0374	368	ST07-0458	369	ST07-0602	370	ST07-0732	373		
ST07-0375	368	ST07-0459	369	ST07-0603	370	ST07-0733	373		
ST07-0376	368	ST07-0460	369	ST07-0604	370	ST07-0734	373		
ST07-0377	368	ST07-0461	369	ST07-0610	371	ST07-0735	373		
ST07-0378	368	ST07-0462	369	ST07-0611	371	ST07-0736	373		
ST07-0379	368	ST07-0463	369	ST07-0612	371	ST07-0737	373		
ST07-0380	368	ST07-0464	369	ST07-0620	371	ST07-0750	373		
ST07-0381	368	ST07-0470	369	ST07-0630	371	ST07-0751	373		
ST07-0382	368	ST07-0471	369	ST07-0631	371	ST07-0752	373		
ST07-0390	368	ST07-0472	369	ST07-0632	371	ST07-0753	373		
ST07-0391	368	ST07-0473	369	ST07-0633	371	ST07-0754	373		
ST07-0392	368	ST07-0474	369	ST07-0634	371	ST07-0755	373		
ST07-0393	368	ST07-0475	369	ST07-0635	371	ST07-0756	373		
ST07-0394	368	ST07-0476	369	ST07-0636	371	ST07-0757	373		
ST07-0395	368	ST07-0477	369	ST07-0637	371	ST07-0758	373		
ST07-0396	368	ST07-0478	369	ST07-0650	371	ST07-0770	373		
ST07-0397	368	ST07-0479	369	ST07-0660	371	ST07-0771	373		
ST07-0398	368	ST07-0480	369	ST07-0661	371	ST07-0772	373		
ST07-0399	368	ST07-0481	369	ST07-0662	371	ST07-0773	373		
ST07-0400	368	ST07-0482	369	ST07-0663	371	ST07-0774	373		
ST07-0401	368	ST07-0500	369	ST07-0664	371	ST07-0775	373		
ST07-0402	368	ST07-0501	369	ST07-0670	372	ST07-0776	373		
ST07-0403	368	ST07-0502	369	ST07-0671	372	ST07-0777	373		
ST07-0404	368	ST07-0503	369	ST07-0672	372	ST07-0778	373		
ST07-0405	368	ST07-0504	369	ST07-0673	372	ST07-0780	374		
ST07-0406	368	ST07-0505	369	ST07-0674	372	ST07-0781	374		
ST07-0407	368	ST07-0510	369	ST07-0675	372	ST07-0782	374		
ST07-0408	368	ST07-0511	369	ST07-0676	372	ST07-0790	374		
ST07-0409	368	ST07-0512	369	ST07-0677	372	ST07-0791	374		
ST07-0410	368	ST07-0520	370	ST07-0678	372	ST07-0792	374		
ST07-0411	368	ST07-0521	370	ST07-0679	372	ST07-0793	374		
ST07-0412	368	ST07-0522	370	ST07-0680	372	ST07-0794	374		
ST07-0413	368	ST07-0523	370	ST07-0681	372	ST07-0800	375		
ST07-0420	368	ST07-0530	370	ST07-0682	372	ST07-0801	375		
ST07-0421	368	ST07-0531	370	ST07-0683	372	ST07-0810	375		
ST07-0422	368	ST07-0532	370	ST07-0684	372	ST07-0811	375		
ST07-0423	368	ST07-0533	370	ST07-0685	372	ST07-0820	375		
ST07-0424	368	ST07-0534	370	ST07-0686	372	ST07-0830	375		
ST07-0425	368	ST07-0535	370	ST07-0687	372	ST07-0840	376		
ST07-0426	368	ST07-0536	370	ST07-0688	372	ST07-0850	376		
ST07-0427	368	ST07-0537	370	ST07-0689	372	ST07-0860	376		
ST07-0428	368	ST07-0550	370	ST07-0690	372	ST07-0870	376		
ST07-0429	368	ST07-0560	370	ST07-0691	372	ST07-0871	376		
ST07-0430	368	ST07-0561	370	ST07-0692	372	ST07-0880	376		
ST07-0431	368	ST07-0562	370	ST07-0693	372	ST07-0881	376		
ST07-0432	368	ST07-0563	370	ST07-0694	372	ST07-0882	376		
ST07-0433	368	ST07-0564	370	ST07-0695	372	ST07-0883	376		

aim-max-medical.dk



aim-max-medical.dk